

SIGN

segnaletica e informazione

IT porta-informazioni per tutti i gusti: in acrilico, in vetro, cartacei, arrotondati o squadrati, con o senza fori, da personalizzare o dove inserire direttamente le informazioni, set completi con distanziali. in tutti i formati piú comuni.

beschilderung und information

DE informationsträger in allen variationen: acryl, glas oder papier, gerundet oder rechteckig, mit und ohne löcher, für ein Schub oder beschriftung, komplette sets mit wandhalter, in allen gängigen grössen.

signage and information

EN information carriers of all kinds: acrylic, glass or paper, rounded or square, with and without holes, with insert for information or for labeling, complete sets with spacers and signs, in all common sizes.





signcode eXtern

MADE IN EU design by KD

IT un perfetto sistema di segnaletica si vede in primo luogo da come le indicazioni collocate all'esterno accolgono i visitatori. grazie alla nostra nuova gamma di signcode extern bifacciale e flessibile è possibile combinare 45 formati diversi in modo modulare. le indicazioni bifacciali possono essere personalizzate tramite stampa diretta o plastificazione. le indicazioni vengono inserite nel prodotto e sono intercambiabili in qualsiasi momento. i materiali sono di alta qualità e adatti all'uso esterno, grazie alle nostre speciali basi, signcode extern avrà un grande successo anche negli spazi interni.

DE zu einem perfekten wegleitungssystem gehört bereits der empfang im aussenbereich. mit unserem doppelseitigem flexiblen signcode extern programm können sie 45 verschiedene masse kombinieren und modular gestalten. die doppel-seitigen tafeln können mit direktdruck oder laminat personalisiert werden, die tafeln werden eingeschoben und sind jederzeit austauschbar. alle materialien sind hochwertig und für den aussenbereich geeignet. aber auch im innenbereich macht signcode extern mit unseren speziellen basen eine gute figur.

EN perfect signage welcomes visitors already to the outdoor area. with our double sided flexible signcode extern program you can combine 45 different sign sizes and design them in a modular way. the double sided signs can be customized with direct print or lamination, the signs are simply inserted and can be exchanged at anytime. all materials used are high grade and perfect for outdoor use. but also for indoors, you can use signcode extern with our special bases.

ideas

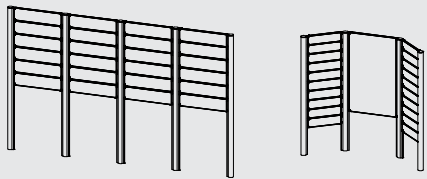

information

alluminio anodizzato color argento, con tappi superiori in argento realizzati in pressofusione. A monolaterale per delimitare zone esterne, B bilaterale per posizionamento centrale.

silber eloxiertes aluminium, kappen aus versilbertem metall-druckguss, A einseitig für aussenbegrenzung, B zweiseitig für mittige position

silver anodized aluminium, caps made of silver plated die-cast metal, A single sided for outside posts, B double sided for center posts

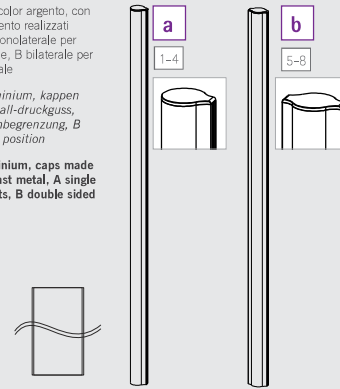

bussola da terra da avvitare su ferro zincato

bodenhülse zum festschrauben auf verzinktem eisen

ground sleeve to be screwed on, made of zincated iron

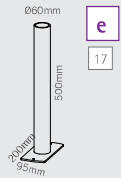

bussola da terra per calcestruzzo o fondamenta in cemento

bodenhülse für beton oder zement fundamente

ground sleeve for concrete installation

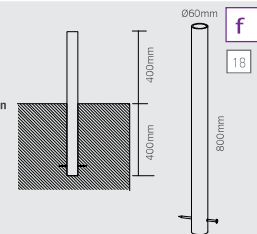

targhe bifacciali con cornici in alluminio anodizzato color argento, angoli realizzati in metallo pressofuso satinato color argento, lastre in alluminio con rivestimento bianco, lastre premontate ed incollate

doppelseitige tafeln mit silber eloxiertem aluminium profilrahmen, matt versilberten metalli druckguss ecken, aluminium platten weiss beschichtet, platten vormontiert und verklebt

double sided signs with silver anodized aluminium frame, matt silver plated die-cast metal corner connectors, aluminium panels with white coating, panels assembled and glued

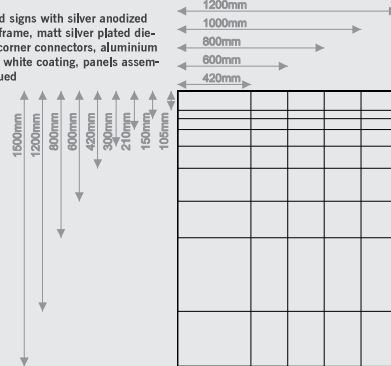

information

alluminio anodizzato color argento, tappi in metallo pressofuso color argento, C bilaterali per delimitare zone esterne, D monolaterali per delimitare zone interne, Solo per spazi interni

silber eloxiertes aluminium, kappen aus versilbertem metall-druckguss, D einseitig für aussenbegrenzung, C zweiseitig für mittige position, nur für innenbereich.

silver anodized aluminium, caps made of silver plated die-cast metal, D single sided for outside posts, C double sided for center posts, only for indoor use.

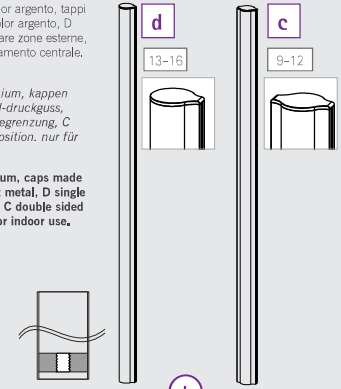

rivestimento di protezione in abs color grigio chiaro, con piastra di metallo, piede solo per l'uso in interno

lichtgraue abs abdeckung mit gewichtsplatte, standfuss nur für innenbereich.

light grey abs cover with weight plate, base only for indoors.

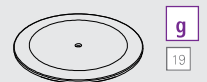

ulteriori informazioni pag. 301
mehr details s. 301
more information p. 301

i moduli possono essere piegati fino a 140°

module können stufenlos bis 140° geneigt werden

modules can be positioned stagelessly up to 140°

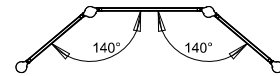

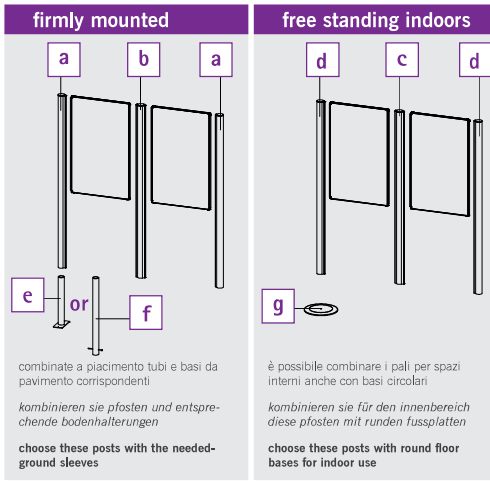

A signcode eXtern

	hxb	
1	SCXPAV1200	post a 1200mm, 2pcs
2	SCXPAV1500	post a 1500mm, 2pcs
3	SCXPAV1800	post a 1800mm, 2pcs
4	SCXPAV2000	post a 2000mm, 2pcs
5	SCXPMV1200	post b 1200mm 1pc
6	SCXPMV1500	post b 1500mm 1pc
7	SCXPMV1800	post b 1800mm 1pc
8	SCXPMV2000	post b 2000mm 1pc
9	SCXPMM1200	post c 1200mm 1pc
10	SCXPMM1500	post c 1500mm 1pc
11	SCXPMM1800	post c 1800mm 1pc
12	SCXPMM2000	post c 2000mm 1pc
13	SCXPAM1200	post d 1200mm 2pcs
14	SCXPAM1500	post d 1500mm 2pcs
15	SCXPAM1800	post d 1800mm 2pcs
16	SCXPAM2000	post d 2000mm 2pcs
17	SCXFLOOR	ground sleeve e, 1pc
18	SCXGROUND	ground sleeve f, 1pc
19	SCXBAR	base for indoors, 1pc
20	SCX105420*	signcode extern 105x420mm, 1pc
21	SCX105600	signcode extern 105x600mm, 1pc
22	SCX105800	signcode extern 105x800mm, 1pc
23	SCX1051000	signcode extern 105x1000mm, 1pc
24	SCX1051200	signcode extern 105x1200mm, 1pc
25	SCX150420*	signcode extern 150x420mm, 1pc
26	SCX150600	signcode extern 150x600mm, 1pc
27	SCX150800	signcode extern 150x800mm, 1pc
28	SCX1501000	signcode extern 150x1000mm, 1pc
29	SCX1501200	signcode extern 150x1200mm, 1pc
30	SCX210420*	signcode extern 210x420mm, 1pc
31	SCX210600	signcode extern 210x600mm, 1pc
32	SCX210800	signcode extern 210x800mm, 1pc

	hxb	
33	SCX2101000	signcode extern 210x1000mm, 1pc
34	SCX2101200	signcode extern 210x1200mm, 1pc
35	SCX300420*	signcode extern 300x420mm, 1pc
36	SCX300600	signcode extern 300x600mm, 1pc
37	SCX300800	signcode extern 300x800mm, 1pc
38	SCX3001000	signcode extern 300x1000mm, 1pc
39	SCX3001200	signcode extern 300x1200mm, 1pc
40	SCX420420*	signcode extern 420x420mm, 1pc
41	SCX420600	signcode extern 420x600mm, 1pc
42	SCX420800	signcode extern 420x800mm, 1pc
43	SCX4201000	signcode extern 420x1000mm, 1pc
44	SCX4201200	signcode extern 420x1200mm, 1pc
45	SCX600420*	signcode extern 600x420mm, 1pc
46	SCX600600	signcode extern 600x600mm, 1pc
47	SCX600800	signcode extern 600x800mm, 1pc
48	SCX6001000	signcode extern 600x1000mm, 1pc
49	SCX6001200	signcode extern 600x1200mm, 1pc
50	SCX800420*	signcode extern 800x420mm, 1pc
51	SCX800600	signcode extern 800x600mm, 1pc
52	SCX800800	signcode extern 800x800mm, 1pc
53	SCX8001000	signcode extern 800x1000mm, 1pc
54	SCX8001200	signcode extern 800x1200mm, 1pc
55	SCX1200420*	signcode extern 1200x420mm, 1pc
56	SCX1200600	signcode extern 1200x600mm, 1pc
57	SCX1200800	signcode extern 1200x800mm, 1pc
58	SCX12001000	signcode extern 1200x1000mm, 1pc
59	SCX12001200	signcode extern 1200x1200mm, 1pc
60	SCX1500420*	signcode extern 1500x420mm, 1pc
61	SCX1500600	signcode extern 1500x600mm, 1pc
62	SCX1500800	signcode extern 1500x800mm, 1pc
63	SCX15001000	signcode extern 1500x1000mm, 1pc
64	SCX15001200	signcode extern 1500x1200mm, 1pc

* fino ad esaurimento scorte | solange vorrat reicht | while stock last



signCODE



inserire nella cornice il pannello in alluminio o in PS trasparente e chiudere il sistema lateralmente.

paneel aus alu oder transparentem PS einschieben und seitlichen verschluss einclicken.

insert panel made of aluminium or transparent PS and click in the lateral side part.



signcode key

utensile per agevolare l'apertura per il cambio delle informazioni, materiale: nylon stampato.

spezialwerkzeug zum einfachen öffnen für austausch der information, kunststoff-spritzguss aus nylon.

special tool for easy opening and exchange of information, injection die-casting made of nylon.

signcode®

MADE IN EU design by KD

IT signcode è il nuovo sistema modulare con chiusura a pressione realizzato con profili in alluminio anodizzato color argento. grazie al design e alla struttura il cambio delle informazioni è sempre pratico e veloce. signcode è disponibile in molti formati, è mono- e bifacciale ed ideale per applicazioni a parete e a soffitto. vi offriamo signcode in due versioni: con un pannello di alluminio verniciato color bianco o con un protettivo trasparente in PS. la cornice smussata con spessore di 4mm e gli angoli stampati in materiale sintetico verniciati in color argento rendono signcode discreto ma tuttavia elegante. per un colpo d'occhio che non passa inosservato.

DE signcode das vielfältige stecksystem mit federverschluss aus silber eloxierten aluminiumprofilen. dank des cleveren designs ist der info-austausch jederzeit schnell und einfach. signcode ist erhältlich in vielen grössen, ein- oder doppelseitig als wand-, decken- oder fahnschild. wir bieten signcode in zwei versionen: mit weiss beschichtetem aluminiumpaneel oder einer transparenten ps-abdeckung. ein gepaster, diskreter rahmen von 4mm und die versilberten kunststoff-spritzgusscken machen ihr signcode zu einem variablen und eleganten hingucker.

EN signcode is the variant connector system with dip locking made of silver anodized aluminium profiles. thanks to the clever design the exchange of information is quick and easy at anytime. signcode is available in many sizes, single and double sided, as wall, flag or ceiling sign. we offer signcode in two different versions: with a white coated aluminium panel or a transparent PS-cover, a beveled and discrete 4mm frame and the silver die-cast synthetic edge connectors make your signcode a variable yet elegant eye-catcher.

A signcode key

1	FSOKEY	signcode key, 2pcs
---	--------	--------------------

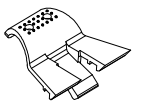



information

suspension **ceiling** **flag** **wall**

*) esempio di utilizzo, su richiesta | anwendungsbeispiel auf anfrage | example of use, on request

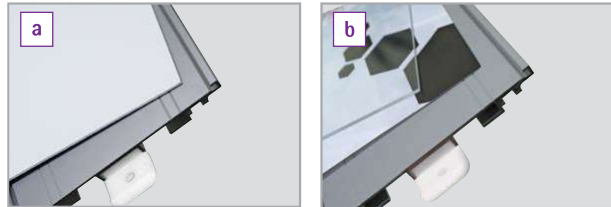

pannello in alluminio, spessore 1,2 mm, di colore bianco RAL9016, per decorazione con pellicole adesive o per stampa diretta, per esempio con il sistema printlux

aluminium panel 1,2mm beschichtet in RAL9016 weiss, für aufkaschieren oder direktdruck, z.b. mit printlux system

aluminium panel 1,2mm coated in RAL9016 white, for laminating or direct printing, e.g. with the printlux system

protettivo trasparente in PS antiriflesso, spessore 1,2 mm, per stampa su carta; sul retro può anche essere decorato con pellicole adesive o stampato direttamente

abdeckung aus 1,2mm starkem nicht reflektierendem PS, für papierdruck, kann aber auch rückseitig aufkaschiert oder direkt bedruckt werden.

cover made of 1,2mm thick non reflective PS, for paper prints, it can also be laminated or printed on the rear side.

grazie alla modularità del sistema sono disponibili molti formati per la parete o il soffitto; mono- e bifacciale; chiusura di sicurezza a pressione, per un cambio informazioni veloce ma a prova di manomissioni

dank stecksystem viele grössen für wand, decke und fahne, ein- und zweiseitig mit cleverem federverschluss, für schnellwechsel und manipulationschutz

thanks to the connector system many different sizes for wall and ceiling, single and double sided, with clever clip lock, quick exchange, tamper proof.



ulteriori informazioni pag. 446
mehr details s. 446
more information p. 446

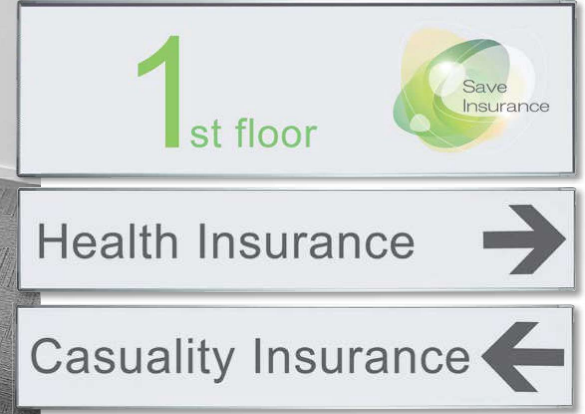

signcode® paper MADE IN EU design by KD

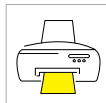

information



IT pratico: inserto cartaceo prefustellato per la personalizzazione del nostro sistema signcode, carta bianco opaco 160g/m in formato A4, prefustellato, inserti centrali 148x148mm.

DE praktisch: vorgestanzte einleger für unsere signcode systeme zum selber drucken: 160g/m papier weissmatt in A4 format mit mittig vorgestanztem einleger 148x148mm.

EN convenient: preprinted paper inlay for our signcode systems for customizing with print: 160g/m paper white matt in A4 format with a center preprinted inlay of 148x148mm.



A signcode paper

1	FSP148148	signcode paper, 148x148mm, 20pcs	size*
---	-----------	----------------------------------	-------

* altezza x larghezza | höhe x breite | height x width

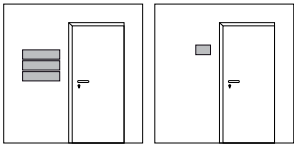

signcode wall

targa a parete monofacciale, materiale per il montaggio incluso
 einseitiges wandschild, montage-material inkl.
 single side wall sign, mounting material incl.



A signcode wall

	hxb	mm	size*
1	FSOW65105AL	65x105	FSOW65105PS
2	FSOW65148AL	65x148	FSOW65148PS
3	FSOW65210AL	65x210	FSOW65210PS
4	FSOW65297AL	65x297	FSOW65297PS
5	FSOW65420AL	65x420	FSOW65420PS
6	FSOW65600AL	65x600	FSOW65600PS
7	FSOW105105AL	105x105	FSOW105105PS
8	FSOW105148AL	105x148	FSOW105148PS
9	FSOW105210AL	105x210	FSOW105210PS
10	FSOW105297AL	105x297	FSOW105297PS
11	FSOW105420AL	105x420	FSOW105420PS
12	FSOW105600AL	105x600	FSOW105600PS
13	FSOW105800AL	105x800	FSOW105800PS
14	FSOW148148AL	148x148	FSOW148148PS
15	FSOW148210AL	148x210	FSOW148210PS
16	FSOW148297AL	148x297	FSOW148297PS
17	FSOW148420AL	148x420	FSOW148420PS
18	FSOW148600AL	148x600	FSOW148600PS
19	FSOW148800AL	148x800	FSOW148800PS
20	FSOW1481000AL	148x1000	FSOW1481000PS
21	FSOW210210AL	210x210	FSOW210210PS
22	FSOW210297AL	210x297	FSOW210297PS
23	FSOW210420AL	210x420	FSOW210420PS
24	FSOW210600AL	210x600	FSOW210600PS
25	FSOW210800AL	210x800	FSOW210800PS
26	FSOW2101000AL	210x1000	FSOW2101000PS
27	FSOW2101200AL	210x1200	FSOW2101200PS
28	FSOW297297AL	297x297	FSOW297297PS
29	FSOW297420AL	297x420	FSOW297420PS
30	FSOW297600AL	297x600	FSOW297600PS
31	FSOW297800AL	297x800	FSOW297800PS
32	FSOW2971000AL	297x1000	FSOW2971000PS
33	FSOW2971200AL	297x1200	FSOW2971200PS

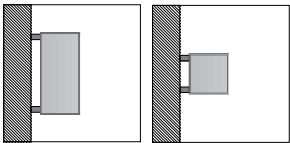

signcode flag

targa a bandiera bifacciale, materiale per il montaggio incluso;
 chiavi a brugola ACHI20 da ordinare separatamente!

doppelseitiges auslegerschild, inbus-schlüssel ACHI20 extra bestellen, montage-material inklusiv

double sided flag sign, order extra hex key ACHI20, mounting material incl.

A signcode flag

	hxb	mm	size*
34	FSOF105105AL	105x105	FSOF105105PS
35	FSOF148105AL	148x105	FSOF148105PS
36	FSOF148148AL	148x148	FSOF148148PS
37	FSOF210105AL	210x105	FSOF210105PS
38	FSOF210148AL	210x148	FSOF210148PS
39	FSOF210210AL	210x210	FSOF210210PS
40	FSOF297105AL	297x105	FSOF297105PS
41	FSOF297148AL	297x148	FSOF297148PS
42	FSOF297210AL	297x210	FSOF297210PS
43	FSOF297297AL	297x297	FSOF297297PS

* altezza x larghezza | höhe x breite | height x width



44
 ordinare extra per flag e ceiling
 inbus-schlüssel für flag und ceiling extra bestellen
 order key for flag and ceiling separately

44 ACHI20 allen key 1 pc

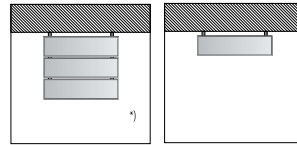
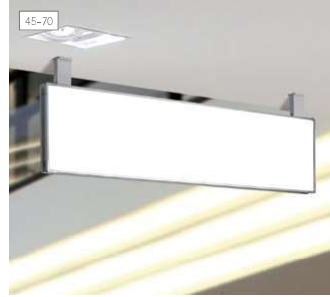

signcode ceiling

signcode ceiling: targa a soffitto bifacciale, materiale per il montaggio incluso; chiavi a brugola ACHI20 da ordinare separatamente! *) esempio di utilizzo, su richiesta

signcode ceiling: doppelseitiges auslegerschild, inbus-schlüssel ACHI20 extra bestellen, montage-material inkl. *) anwendungsbeispiel auf anfrage

signcode ceiling: double sided flag sign, order extra hex key ACHI20, mounting material incl. *) example of use, on request

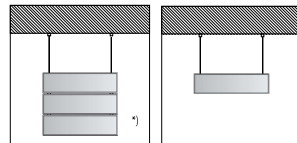

signcode suspension

signcode suspension: sistema bifacciale sospeso su cavi di acciaio, sospensione dal soffitto variabile fino ad un massimo di 1m di distanza, materiale per il montaggio incluso
 *) esempio di utilizzo, su richiesta

signcode suspension: doppelseitig für abhängung am seil, stufenlos verstellbar bis max. 1m deckenabstand, montage-material inkl. *) anwendungsbeispiel auf anfrage

signcode suspension: double-side sign for ceiling suspension, steplessly adjustable up to max. 1m ceiling distance, order extra hex key ACHI20, mounting material incl. *) example of use, on request



SIGNCODE KEY
 pag. 367

A signcode ceiling

	hxb	mm	size*
45	FSOC65210AL	65x210	FSOC65210PS
46	FSOC65297AL	65x297	FSOC65297PS
47	FSOC65420AL	65x420	FSOC65420PS
48	FSOC65600AL	65x600	FSOC65600PS
49	FSOC65800AL	65x800	FSOC65800PS
50	FSOC105210AL	105x210	FSOC105210PS
51	FSOC105297AL	105x297	FSOC105297PS
52	FSOC105420AL	105x420	FSOC105420PS
53	FSOC105600AL	105x600	FSOC105600PS
54	FSOC105800AL	105x800	FSOC105800PS
55	FSOC1051000AL	105x1000	FSOC1051000PS
56	FSOC148297AL	148x297	FSOC148297PS
57	FSOC148420AL	148x420	FSOC148420PS
58	FSOC148600AL	148x600	FSOC148600PS
59	FSOC148800AL	148x800	FSOC148800PS
60	FSOC1481000AL	148x1000	FSOC1481000PS
61	FSOC1481200AL	148x1200	FSOC1481200PS
62	FSOC210420AL	210x420	FSOC210420PS
63	FSOC210600AL	210x600	FSOC210600PS
64	FSOC210800AL	210x800	FSOC210800PS
65	FSOC2101000AL	210x1000	FSOC2101000PS
66	FSOC2101200AL	210x1200	FSOC2101200PS
67	FSOC297600AL	297x600	FSOC297600PS
68	FSOC297800AL	297x800	FSOC297800PS
69	FSOC2971000AL	297x1000	FSOC2971000PS
70	FSOC2971200AL	297x1200	FSOC2971200PS

A signcode suspension

	hxb	mm	size*
71	FSOS65210AL	65x210	FSOS65210PS
72	FSOS65297AL	65x297	FSOS65297PS
73	FSOS65420AL	65x420	FSOS65420PS
74	FSOS65600AL	65x600	FSOS65600PS
75	FSOS65800AL	65x800	FSOS65800PS
76	FSOS105210AL	105x210	FSOS105210PS
77	FSOS105297AL	105x297	FSOS105297PS
78	FSOS105420AL	105x420	FSOS105420PS
79	FSOS105600AL	105x600	FSOS105600PS
80	FSOS105800AL	105x800	FSOS105800PS
81	FSOS1051000AL	105x1000	FSOS1051000PS
82	FSOS148297AL	148x297	FSOS148297PS
83	FSOS148420AL	148x420	FSOS148420PS
84	FSOS148600AL	148x600	FSOS148600PS
85	FSOS148800AL	148x800	FSOS148800PS
86	FSOS1481000AL	148x1000	FSOS1481000PS
87	FSOS1481200AL	148x1200	FSOS1481200PS
88	FSOS210420AL	210x420	FSOS210420PS
89	FSOS210600AL	210x600	FSOS210600PS
90	FSOS210800AL	210x800	FSOS210800PS
91	FSOS2101000AL	210x1000	FSOS2101000PS
92	FSOS2101200AL	210x1200	FSOS2101200PS
93	FSOS297600AL	297x600	FSOS297600PS
94	FSOS297800AL	297x800	FSOS297800PS
95	FSOS2971000AL	297x1000	FSOS2971000PS
96	FSOS2971200AL	297x1200	FSOS2971200PS

* altezza x larghezza | höhe x breite | height x width

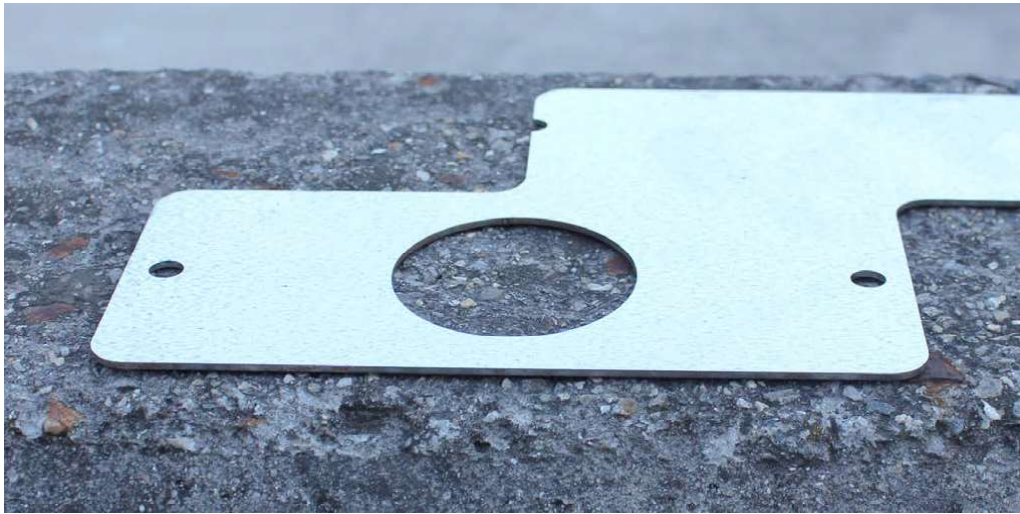

dima

MADE IN EU design by KD

IT questa pratica dima è stata pensata per facilitare il montaggio dei sistemi di segnaletica outdoor signcode estern e pylo outdoor, entrambi i modelli disponibili sono in metallo zincato, possono essere impostati in modo variabile e si abbinano perfettamente ai due rispettivi sistemi. in questo modo potrà risparmiare tempo e rendere il montaggio ancora più veloce.

DE für die montage unserer info-leitsysteme im aussenbereich: signcode extern und pylo outdoor bieten wir praktische montage-schablonen an. beide schablonen sind aus verzinktem metall, variabel einstellbar und passen genau zu den jeweiligen modellen, damit wird die montage dieser systeme noch einfacher und sie sparen zeit!

EN to mount the signage systems signcode extern and pylo outdoor we provide you with convenient jigs. both jigs are made of zincated metal and can be adjusted according to the relative models, our dima makes your job more easy and safes you time!

information

for pylo outdoor

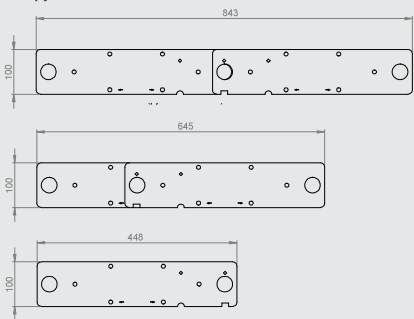

A dima

1	SOPYODIMA	dima for pylo outdoor, 1pc
2	SCXDIMA	dima for signcode extern, 1pc



information

for signcode extern

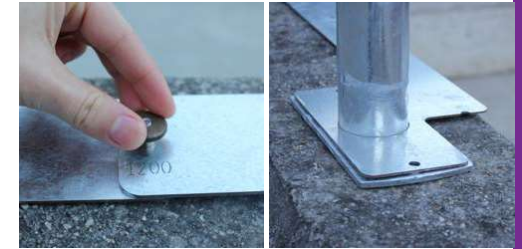
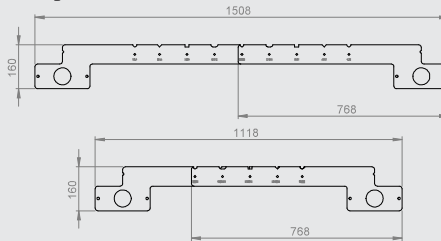

impostare
einstellen
adjust

posizionare
positionieren
position



perforare
bohren
drill

fissare
befestigen
fix

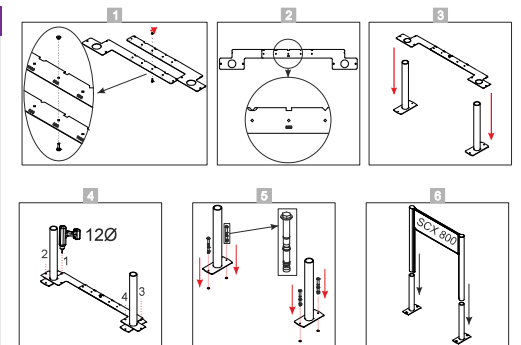



signcode® colors

MADE IN EU design by KD

IT l'innovativa segnaletica signcode colors offre un sistema direzionale a colori integrato nella cornice, adatti per indicatori a bandiera verticali o orizzontali. oltre ai 4 colori standard della segnaletica di sicurezza, diamo la possibilità di scegliere fra ulteriori 4 colori. come già previsto dal sistema signcode, anche in questo caso sono disponibili le due versioni: con pannelli in alluminio per stampa diretta o con un protettivo trasparente in PS, che permette l'inserimento di stampe realizzate su supporto cartaceo. entrambi i sistemi sono a prova di manomissione, ma permettono comunque una semplice e veloce sostituzione d'informazioni evitando di smontare l'intera targa. signcode colors: segnaletica innovativa con un moderno sistema direzionale a colori.

DE das innovative beschilderungssystem signcode colors bietet exklusiv ein rahmenintegriertes farbleitsystem der vertikalen bzw. bei fahnschilder der horizontalen seiten, neben den 4 normfarben für die sicherheitsbeschilderung bieten wir ihnen weitere 4 farben zur auswahl. wie beim signcode system können sie direktbedruckte paneele verwenden oder die version mit papiereinleger hinter transparenter abdeckung. beide systeme haben einen manipulationschutz und können dennoch jederzeit ganz einfach ohne demontage gewechselt werden. signcode colors: innovative beschilderung mit modernem farbleitsystem.

EN the innovative signage system signcode colors offers you a directional system with colours integrated into the frame, adapt for both flag or horizontal use. over and above the 4 standard security colours, we give you the choice of a further 4 colours. just like the signcode signage you can use panels with direct print or paper print under transparent covers. both systems have a tamper-proof lock and you can change the information anytime easily without disassembling. signcode colors. innovate signage with modern color coding.



pannello in alluminio, spessore 1,2 mm, di colore bianco RAL9016, per decorazione con pellicole adesive o per stampa diretta, per esempio con il sistema printolux

aluminium panel 1,2mm beschichtet in RAL9016 weiss, für aufkaschieren oder direktdruck, z.b. mit printolux system

aluminium panel 1,2mm coated in RAL9016 white, for laminating or direct printing, e.g. with the printolux system



protettivo trasparente in PS antriflesso, spessore 1,2 mm, per stampa su carta; sul retro può anche essere decorato con pellicole adesive o stampato direttamente

abdeckung aus 1,2mm starkem nicht reflektierendem PS, für papierdruck, kann aber auch rückseitig aufkaschiert oder direkt bedruckt werden.

cover made of 1,2mm thick non reflective PS, for paper prints, it can also be laminated or printed on the rear side.



inserire nella cornice il pannello in alluminio o in PS trasparente e chiudere il sistema lateralmente. per aprire la cornice basta premere sul gancio di sicurezza con una tessera plastificata tipo carta di credito.

paneel aus alu oder transparentem PS einschieben und seitlichen verschluss einclicken. zum öffnen einfach die sicherung mit einer scheckkarte lösen.

insert panel made of aluminium or transparent PS and click in the lateral side part. for opening simply loosen the latch with a slim card.



SIGNCODE PAPER pag. 367

information

suspension

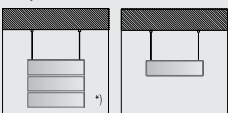

ceiling



flag

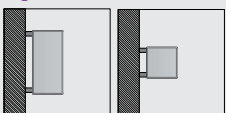

wall



*) esempio di utilizzo, su richiesta | anwendungsbeispiel auf anfrage | example of use, on request



*) inserire la sigla del colore nel campo bianco | farbcodes im weißen feld eintragen | insert the colour code in the blank space

sceita di colori | farbauswahl | choice of colors

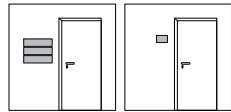
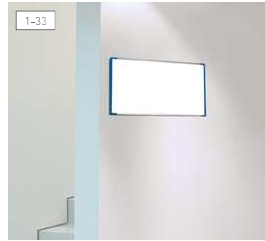

signcode wall

targa a parete monofacciale, materiale per il montaggio incluso
einsseitiges wandschild, montage material inkl.

single side wall sign, mounting material incl.

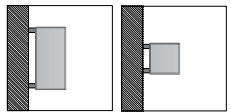
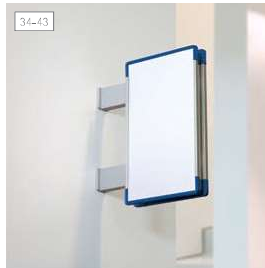

signcode flag

targa a bandiera bifacciale, lati orizzontali colorati
doppelseitiges auslegerschild, farbteilsystem horizontal

double sided flag sign, horizontal sides coloured



A signcode wall

	hxb	mm	size*
1	FSYW65105AL	65x105	FSYW65105PS
2	FSYW65148AL	65x148	FSYW65148PS
3	FSYW65210AL	65x210	FSYW65210PS
4	FSYW65297AL	65x297	FSYW65297PS
5	FSYW65420AL	65x420	FSYW65420PS
6	FSYW65600AL	65x600	FSYW65600PS
7	FSYW105105AL	105x105	FSYW105105PS
8	FSYW105148AL	105x148	FSYW105148PS
9	FSYW105210AL	105x210	FSYW105210PS
10	FSYW105297AL	105x297	FSYW105297PS
11	FSYW105420AL	105x420	FSYW105420PS
12	FSYW105600AL	105x600	FSYW105600PS
13	FSYW105800AL	105x800	FSYW105800PS
14	FSYW148148AL	148x148	FSYW148148PS
15	FSYW148210AL	148x210	FSYW148210PS
16	FSYW148297AL	148x297	FSYW148297PS
17	FSYW148420AL	148x420	FSYW148420PS
18	FSYW148600AL	148x600	FSYW148600PS
19	FSYW148800AL	148x800	FSYW148800PS
20	FSYW1481000AL	148x1000	FSYW1481000PS
21	FSYW210210AL	210x210	FSYW210210PS
22	FSYW210297AL	210x297	FSYW210297PS
23	FSYW210420AL	210x420	FSYW210420PS
24	FSYW210600AL	210x600	FSYW210600PS
25	FSYW210800AL	210x800	FSYW210800PS
26	FSYW2101000AL	210x1000	FSYW2101000PS
27	FSYW2101200AL	210x1200	FSYW2101200PS
28	FSYW297297AL	297x297	FSYW297297PS
29	FSYW297420AL	297x420	FSYW297420PS
30	FSYW297600AL	297x600	FSYW297600PS
31	FSYW297800AL	297x800	FSYW297800PS
32	FSYW2971000AL	297x1000	FSYW2971000PS
33	FSYW2971200AL	297x1200	FSYW2971200PS

A signcode flag

	hxb	mm	size*
34	FSYF105105AL	105x105	FSYF105105PS
35	FSYF148105AL	148x105	FSYF148105PS
36	FSYF148148AL	148x148	FSYF148148PS
37	FSYF210105AL	210x105	FSYF210105PS
38	FSYF210148AL	210x148	FSYF210148PS
39	FSYF210210AL	210x210	FSYF210210PS
40	FSYF297105AL	297x105	FSYF297105PS
41	FSYF297148AL	297x148	FSYF297148PS
42	FSYF297210AL	297x210	FSYF297210PS
43	FSYF297297AL	297x297	FSYF297297PS

* altezza x larghezza | höhe x breite | height x width



ordinare extra per flag e ceiling
inbus-schlüssel für flag und ceiling extra bestellen
order key for flag and ceiling separately

44 ACHI20 allen key 1 pc

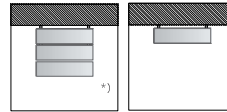
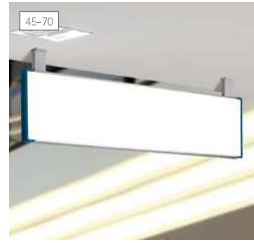

signcode ceiling

signcode ceiling: targa a soffitto bifacciale, materiale per il montaggio incluso, chiavi a brugola ACHI20 da ordinare separatamente! *) esempio di utilizzo, su richiesta

signcode ceiling: doppelseitiges auslegerschild, inbus-schlüssel ACHI20 extra bestellen, montage material inkl. *) anwendungsbeispiel auf anfrage

signcode ceiling: double sided flag sign, order extra hex key ACHI20, mounting material incl. *) example of use, on request

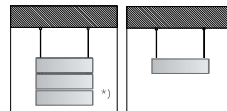
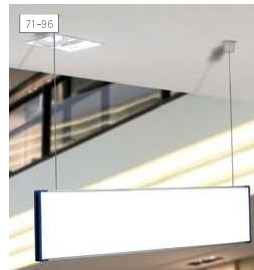

signcode suspension

signcode suspension: sistema bifacciale sospeso su cavi di acciaio, sospensione dal soffitto variabile fino ad un massimo di 1m di distanza, materiale per il montaggio incluso
*) esempio di utilizzo, su richiesta

signcode suspension: doppelseitig für abhängerung am seil, stufenlos verstellbar bis max. 1m deckenabstand, montage material inkl. *) anwendungsbeispiel auf anfrage

signcode suspension: double-side sign for ceiling suspension, steplessly adjustable up to max. 1m ceiling distance, order extra hex key ACHI20, mounting material incl. *) example of use, on request

A signcode ceiling

	hxb	mm	size*
45	FSYC65210AL	65x210	FSYC65210PS
46	FSYC65297AL	65x297	FSYC65297PS
47	FSYC65420AL	65x420	FSYC65420PS
48	FSYC65600AL	65x600	FSYC65600PS
49	FSYC65800AL	65x800	FSYC65800PS
50	FSYC105210AL	105x210	FSYC105210PS
51	FSYC105297AL	105x297	FSYC105297PS
52	FSYC105420AL	105x420	FSYC105420PS
53	FSYC105600AL	105x600	FSYC105600PS
54	FSYC105800AL	105x800	FSYC105800PS
55	FSYC1051000AL	105x1000	FSYC1051000PS
56	FSYC148297AL	148x297	FSYC148297PS
57	FSYC148420AL	148x420	FSYC148420PS
58	FSYC148600AL	148x600	FSYC148600PS
59	FSYC148800AL	148x800	FSYC148800PS
60	FSYC1481000AL	148x1000	FSYC1481000PS
61	FSYC1481200AL	148x1200	FSYC1481200PS
62	FSYC210420AL	210x420	FSYC210420PS
63	FSYC210600AL	210x600	FSYC210600PS
64	FSYC210800AL	210x800	FSYC210800PS
65	FSYC2101000AL	210x1000	FSYC2101000PS
66	FSYC2101200AL	210x1200	FSYC2101200PS
67	FSYC297600AL	297x600	FSYC297600PS
68	FSYC297800AL	297x800	FSYC297800PS
69	FSYC2971000AL	297x1000	FSYC2971000PS
70	FSYC2971200AL	297x1200	FSYC2971200PS

A signcode suspension

	hxb	mm	size*
71	FSYS65210AL	65x210	FSYS65210PS
72	FSYS65297AL	65x297	FSYS65297PS
73	FSYS65420AL	65x420	FSYS65420PS
74	FSYS65600AL	65x600	FSYS65600PS
75	FSYS65800AL	65x800	FSYS65800PS
76	FSYS105210AL	105x210	FSYS105210PS
77	FSYS105297AL	105x297	FSYS105297PS
78	FSYS105420AL	105x420	FSYS105420PS
79	FSYS105600AL	105x600	FSYS105600PS
80	FSYS105800AL	105x800	FSYS105800PS
81	FSYS1051000AL	105x1000	FSYS1051000PS
82	FSYS148297AL	148x297	FSYS148297PS
83	FSYS148420AL	148x420	FSYS148420PS
84	FSYS148600AL	148x600	FSYS148600PS
85	FSYS148800AL	148x800	FSYS148800PS
86	FSYS1481000AL	148x1000	FSYS1481000PS
87	FSYS1481200AL	148x1200	FSYS1481200PS
88	FSYS210420AL	210x420	FSYS210420PS
89	FSYS210600AL	210x600	FSYS210600PS
90	FSYS210800AL	210x800	FSYS210800PS
91	FSYS2101000AL	210x1000	FSYS2101000PS
92	FSYS2101200AL	210x1200	FSYS2101200PS
93	FSYS297600AL	297x600	FSYS297600PS
94	FSYS297800AL	297x800	FSYS297800PS
95	FSYS2971000AL	297x1000	FSYS2971000PS
96	FSYS2971200AL	297x1200	FSYS2971200PS

* altezza x larghezza | höhe x breite | height x width



signcode® braille

MADE IN EU design by KD

IT offriamo anche una segnaletica in braille con simboli a rilievo, integrata nei nostri pannelli signcode e signcode color. per lo sfondo e per i simboli in rilievo mettiamo a disposizione vari colori, ogni realizzazione prevede una lavorazione su misura ed è quindi realizzato a richiesta in base alle vostre esigenze e richieste. per ulteriori informazioni su questo prodotto esclusivo, non esitate a contattarci.

DE beschilderung mit braille-schrift und tastbaren symbolen verwirklichen wir gerne für ihr projekt. wir verwenden dazu unsere systeme signcode oder signcode color als grundlage. für hintergrund sowie für die haptischen bereiche bieten wir diverse farben an. jedes schild ist eine einzelanfertigung und wird genau nach ihrer vorgabe gefertigt. fragen sie uns, wir beraten sie gerne persönlich.

EN we realize also signage with braille and palpable symbols for your projects. we use our systems signcode or signcode colors as the base. for the background and the touchable areas we offer different colours. every sign is a custom made product and is made according to your design. please contact us for more details on this exclusive product.

prezzi su richiesta
prices auf anfrage
prices on demand



2
signcode in-out, german, 148x148mm



information

alluminio anodizzato color argento, parti laterali color grigio chiaro realizzate in materiale sintetico, stampa diretta tramite il sistema printolux

silber eloxiertes aluminium, lichtgraue kunststoff seiten, direktdruck mit printolux system

silver anodized aluminium, light grey synthetic lateral parts, direct print with printolux system



signcode® in-out

MADE IN EU design by KD

IT chiarezza a colpo d'occhio, informazione immediata, per sapere se una sala è occupata o no... tutto ciò è possibile grazie a signcode in-out! Spostate semplicemente la targhetta in rilievo con la mano e in un attimo sarà possibile informare tutti. signcode in-out è disponibile come standard in 3 lingue, ma possibile realizzare altri motivi. contattateci per ulteriori chiarimenti.

DE mit einem blick klarheit, ob ein raum frei ist oder belegt ist? signcode in-out macht's möglich! einfach das deckschild mit einem handgriff verschieben und schon weiss jeder bescheid. standardmässig bieten wir in-out in 3 sprachen, gerne realisieren wir auch andere motive. fragen sie uns, wir beraten sie gerne.

EN understand immediately if a room is free or not? signcode in-out can give you that information just with one slight move by the hand, the cover is easily switched and at once everybody is informed. we provide signcode in-out in 3 different languages but also customized images are possible. please contact us directly for further details.



3 languages



A signcode in-out

		size*
1	SIOIT148148AL in-out, italian, 148x148mm, 1 pc	
2	SIODE148148AL in-out, german, 148x148mm, 1 pc	
3	SIOEN148148AL in-out, english, 148x148mm, 1 pc	

* altezza x larghezza | höhe x breite | height x width



signcode plus wall



IT signcode plus wall, un sistema in perfetto abbinamento con la serie signcode extern. il grande vantaggio? i pannelli vengono fissati a scatto. in questo modo sarà possibile sostituirli in ogni momento senza dover smontare l'intera struttura. nel volume di consegna riceverà delle clip con nastro biadesivo da montare al pannello, quest'ultimo potrà poi essere fissato a scatto alla cornice. per toglierlo in seguito basterà utilizzare una semplice ventosa. i pannelli possono essere personalizzati tramite stampa diretta o laminatura. una soluzione perfetta per la segnaletica indoor e outdoor in grande formato.

DE passend zur signcode extern serie unser system signcode plus wall für die wandmontage. der drou dabei: die paneele werden einfach eingeklickt und sind damit jederzeit schnell und ohne demontage des rahmens austauschbar, sie montieren die im lieferumfang enthaltenen clips mit doppelkleber am paneel und klicken das paneel in den rahmen ein, abgenommen wird das montierte paneel dann ganz einfach mit einem haftsauer, die paneele sind mit direktdruck oder laminat personalisierbar. wir empfehlen signcode plus wall für grossformatige beschilderung im innen- und aussenbereich.

EN matching with our signcode extern series we recommend the system signcode plus wall for signage with bigger format in- and outdoor. the chief attraction is the click system: panels are simply clicked to the frame and are thus quick exchangeable without disassembling of the frame. you mount the clips with double adhesive tape to the panel and simply click it on the profile frame. you can easily remove the panel with a suction cup. the panels are perfectly customizable with direct print or laminate.



pulire il pannello, posizionare e incollare le clip
paneel reinigen, clips positionieren und aufkleben
clean panel, place clips and glue



rimuovere gli elementi ausiliari montaggiohilfe entfernen
remove positioning pattern



far scattare il pannello nella cornice
das paneel in den rahmen einklicken
click the panel to the frame



per rimuovere il pannello utilizzare una ventosa
zum austausch paneel mit haftsauer abheben
lift the panel to remove with suction cup

A signcode plus wall description hxb

1	FSPW420420	signcode plus wall 420x420mm, 1pc	
2	FSPW600600	signcode plus wall 600x600mm, 1pc	
3	FSPW900600	signcode plus wall 900x600mm, 1pc	
4	FSPW9001200	signcode plus wall 900x1200mm, 1pc	
5	FSPW12001500	signcode plus wall 1200x1500mm, 1pc	

advantages

- ✓ sistema a scatto: cambio del pannello senza smontaggio o attrezzi
Klicksystem: paneeltausch ohne demontage und werkzeug
exchange panels without disassembling and without tools
- ✓ ideale in ambienti outdoor
ideal für außenbereich
perfect for outdoor application

information

profilo in alluminio anodizzato color argento, angoli in metallo pressofuso color argento, clips in materiale plastico bianco, distanza dal muro 20 mm

silber eloxiertes alu-profil, silbermatte metall-druckguss-ecken, 1,5mm weiß beschichtetes alu-paneel, weiße kunststoff-clips, wandabstand 20mm

silver anodized aluminium profile, silver matt metal die-cast corners, 1,5mm white coated aluminium panel, white synthetic clips, wall distance 20mm



signcode plus suspension & flag



suspension



IT signcode plus suspension segue il design della cornice di signcode extern ed è utilizzabile sia in ambienti esterni che interni come sistema di segnaletica bifacciale su cavi a soffitto. signcode plus flag è pensato invece come segnaletica bifacciale a bandiera. i pannelli vengono personalizzati tramite stampa diretta o laminatura per poi essere incollati alla cornice con il silicone.

DE signcode plus suspension folgt dem rahmendesign von signcode extern und kommt im innen- und aussenbereich als doppelseitiger info-träger decken-abgehängt am seil zum einsatz. signcode flag plus eignet sich für die wandmontage als doppelseitiges fahnen Schild. die paneele werden mit direktdruck oder laminat personalisiert und danach mit silikon verklebt.

EN signcode plus suspension follows the frame design of signcode extern and is applied in- and outdoors as a suspended, double-side information sign. signcode flag plus is perfect for wallmounted flag signs. the panels are customized with direct print or laminate and then glued with silicone to the frame.

flag



attaccare il pannello con silicone
paneele mit silikon verkleben
glue the panels with silicone

advantages

- ✓ look in perfetto abbinamento con signcode plus e signcode extern
passend im look zu signcode plus und signcode extern
matching look with signcode plus and signcode extern
- ✓ perfetto in ambienti esterni e interni
für innen und außen
for in- and outdoor

information

profilo in alluminio anodizzato color argento, angoli in metallo pressofuso color argento, pannello con spessore 1,5mm in alluminio color bianco, dopo la stampa fissare il pannello con silicone

silber eloxiertes alu-profil, silbermatte metall-druckguss-ecken, 1,5mm weiß beschichtetes alu-paneel, paneele mit silikon selbst nach bedrucken befestigen

silver anodized aluminium profile, silver matt metal die-cast corners, 1,5mm white coated aluminium panel, panel fixing with silicone after print

suspension

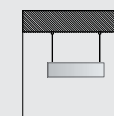

flag

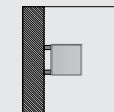

A signcode plus suspension description hxb

1	FSPS105600	signcode plus suspension 105x600mm	
2	FSPS105800	signcode plus suspension 105x800mm	
3	FSPS1051000	signcode plus suspension 105x1000mm	
4	FSPS1051200	signcode plus suspension 105x1200mm	
5	FSPS148600	signcode plus suspension 148x600mm	
6	FSPS148800	signcode plus suspension 148x800mm	
7	FSPS1481000	signcode plus suspension 148x1000mm	
8	FSPS1481200	signcode plus suspension 148x1200mm	
9	FSPS210600	signcode plus suspension 210x600mm	
10	FSPS210800	signcode plus suspension 210x800mm	
11	FSPS2101000	signcode plus suspension 210x1000mm	
12	FSPS2101200	signcode plus suspension 210x1200mm	

A signcode plus flag description hxb

13	FSPF148148	signcode plus flag 148x148mm, 1pc	
14	FSPF210210	signcode plus flag 210x210mm, 1pc	
15	FSPF148300	signcode plus flag 148x300mm, 1pc	
16	FSPF210300	signcode plus flag 210x300mm, 1pc	



signshine®

C 3
calling 148x297mm



- pannello fotoluminescente a lunga durata
- segnaletica di sicurezza in formato DIN 67510-1
- illumina uscite di sicurezza ed estintori al buio
- privo di sostanze nocive: privo di cadmio, non radioattivo
- prolungata luminescenza: autonomia superiore alle 12 ore
- luminescenza superiore allo standard normativo richiesto
- tonalità giallo chiaro: stampa indelebile
- luminescenza color verde-giallo



- nachleuchtendes photoluminiszierendes paneel
- gemäss DIN 67510-1 für sicherheitsbeschilderung
- zeigt fluchtwege und löschhilfen im dunkeln
- schadstoff-geprüft: cadmium frei, nicht radioaktiv
- nachhaltige leuchtkraft: über 12 stunden
- hohe leuchtstärke: vielfaches über normforderung
- geringer gelbstich – farbechte bedruckung
- leuchtet in gelbgrün



- after glow, photo luminescent panel
- according to din 67510-1 for security signs
- shows escape routes and fire extinguishers in the dark
- tested for harmful substances: cadmium free, not radioactive
- long after glow: more than 12 hours
- high luminous intensity: much higher than standards demand
- light yellow appearance: color fast print
- glowing colour is yellow

signshine®
DIN 67510

MADE IN EU design by KD

IT segnaletica di sicurezza luminescente di lunga durata unita all'intelligente sistema signcode: signshine offre una serigrafia realizzata su pvc fotoluminescente, ad alta e prolungata luminescenza. è possibile ricaricare signshine molto di frequente, è certificato per segnaletica interna e ha un'autonomia superiore alle 12 ore. offriamo misure standard per segnaletica a parete, a bandiera e a soffitto, o in alternativa anche solo i pannelli stampati con adesivo per l'applicazione, i lati colorati (le parti orizzontali rispettivamente le parti verticali per sistemi flag) sono in corrispondenza con il pittogramma scelto.

DE nachleuchtende sicherheitsbeschilderung mit dem intelligenten signcode system: signshine bietet siebdruck auf photoluminiszierendem pvc mit hoher leuchtdichte und langer nachleuchtzeit. signshine lädt sich beliebig oft auf, ist zertifiziert für raumbeschilderung und leuchtet über 12 stunden nach. wir bieten standard grössen als wand-, ausleger- oder deckenschild oder einfach nur als bedrucktes paneel zum aufkleben, bei der schilddausführung ist der vertikale rahmen - bei fahnschild flag der horizontale - farblich auf das motiv abgestimmt.

EN after glow security signage with the intelligent signcode system: signshine offers silk screen prints on photo luminescent pvc panels with high luminance intensity and long after glow time. signshine has unlimited reenergizing capacity, it is certified for security signage and glows in the dark more than 12 hours. we offer standard sizes as wall, flag or ceiling signs as well as the printed panel with adhesive tape, the signs come with a vertical - flag signs with horizontal - frame colour matching the icon.

	signshine		DIN 67510-1	
	10min	60min	10min	60min
after glow intensity	70	9	20	3
after glow time	>800min			
colour appearance	light yellow			
after glow colour	yellow green			

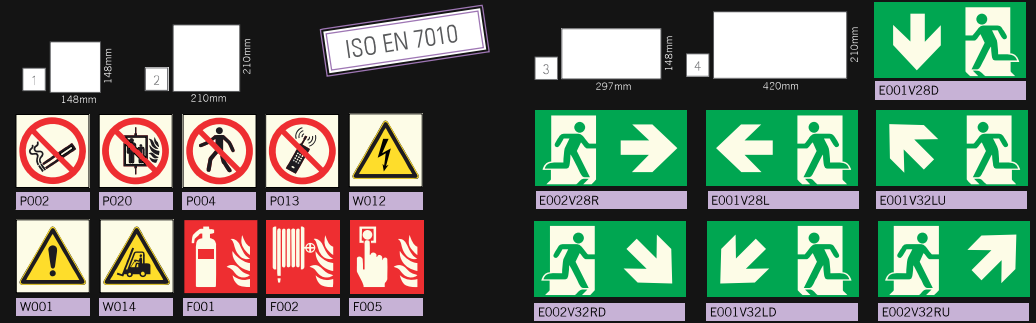

information

a wall

b flag

c ceiling

application on demand

d suspension

application on demand

information

pannello rigido in PVC fotoluminescente, retro biadesivo, stampato con pittogrammi di sicurezza

nachleuchtende pvc hartplatte, rückseitig doppelkleber, bedruckt mit sicherheitsmotiv

photo luminescent pvc rigid plate, adhesive tape on rear side, printed with safety images

signshine complete A

1	SSHW148148	wall 148x148mm, 1pc	size*
2	SSHW210210	wall 210x210mm, 1pc	
3	SSHW148297	wall 148x297mm, 1pc	
4	SSHW210420	wall 210x420mm, 1pc	

1	SSHF148148	flag 148x148mm, 1pc	size*
2	SSHF210210	flag 210x210mm, 1pc	
3	SSHF148297	flag 148x297mm, 1pc	

1	SSHC148148	ceiling 148x148mm, 1pc	size*
2	SSHC210210	ceiling 210x210mm, 1pc	
3	SSHC148297	ceiling 148x297mm, 1pc	
4	SSHC210420	ceiling 210x420mm, 1pc	

1	SSHS148148	suspension 148x148mm, 1pc	size*
2	SSHS210210	suspension 210x210mm, 1pc	
3	SSHS148297	suspension 148x297mm, 1pc	
4	SSHS210420	suspension 210x420mm, 1pc	

signshine plate B

1	SSHP148148	rigid panel 148x148mm, 1pc	size*
2	SSHP210210	rigid panel 210x210mm, 1pc	
3	SSHP148297	rigid panel 148x297mm, 1pc	
4	SSHP210420	rigid panel 210x420mm, 1pc	

* altezza x larghezza | höhe x breite | height x width

signshine® panel



adhesive tape



pannello fotoluminescente ad alta autonomia da personalizzare tramite stampa serigrafica o inchiostro solvente; spessore 1,2mm
pannello rigido biadesivo in pvc

nachleuchtendes paneel zum selbst bedrucken mit siebdruck oder solvent ink. 1,2mm stark, mit doppelklebefolie, pvc hartplatte

photo luminescent panel can be printed with silk screen or solvent ink. 1,2mm thick, with double adhesive tape, pvc rigid panel

signshine® panel

1	SSH12001000	1200x1000mm
---	-------------	-------------



signcode® secure

MADE IN EU design by KD

IT segnaletica a parete completa di pittogrammi e angoli e cornici verticali del colore corrispondente al pittogramma stesso per uso interno: signcode secure vi offre una segnaletica completa, disponibile in quattro formati standard con pittogrammi realizzati in serigrafia per segnaletica di evacuazione e direzione. i pittogrammi possono essere sostituiti in modo facile e veloce grazie all'intelligente sistema signcode.

DE fertige wandbeschilderung mit sicherheitsmotiven und passender rahmenfarbkennung für den innenbereich: signcode secure hat alles schon fix fertig für sie. erhältlich in vier standardgrößen und besiedruckt mit den gängigsten motiven für fluchtweg- und sicherheitsleitsysteme, die motive lassen sich dank des cleveren signcode systems jederzeit ganz einfach austauschen.

EN ready made wall signage with security images and matching frame colours for indoor use: signcode secure has everything already for you. available in four standard sizes with silk screen prints of the most common icons for escape routes and security signage, the images can be exchanged anytime easily thanks to the clever signcode design.

new standard ISO EN 7010



A signcode secure

a WALL

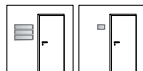

		size*
1	SCD148148	secure, 148x148mm, 1pc
2	SCD210210	secure, 210x210mm, 1pc
3	SCD148297	secure, 148x297mm, 1pc
4	SCD210420	secure, 210x420mm, 1pc

b FLAG



		size*
5	SCDF148148	flag, 148x148mm, 1pc
6	SCDF210210	flag, 210x210mm, 1pc
7	SCDF148297	flag, 148x297mm, 1pc

c SUSPENSION

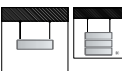

		size*
8	SCDS148148	suspension, 148x148mm, 1pc
9	SCDS210210	suspension, 210x210mm, 1pc
10	SCDS148297	suspension, 148x297mm, 1pc
11	SCDS210420	suspension, 210x420mm, 1pc

* altezza x larghezza | höhe x breite | height x width

information

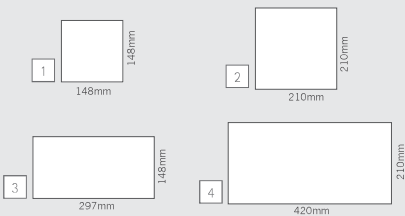

fire extinguishers not included

fireman

MADE IN EU design by KD

IT fireman è il segnalatore autoportante per estintori, ideale laddove non sia possibile allestire un tipo di segnaletica permanente; per esempio in ambienti vincolati alla tutela dei monumenti o per eventi itineranti di ogni tipo, è sufficiente posizionare l'espositore fireman e appoggiare l'estintore sulla base. in caso di emergenza l'estintore è facilmente identificabile e sempre pronto all'uso.

DE fireman die mobile beschilderung ist genau das richtige, wenn eine fixe sicherheitsbeschilderung nicht erwünscht oder möglich ist, wie z.b. in denkmalgeschützten gebäuden und bei events aller art, fireman einfach aufstellen und den löschers auf die basis stellen. im ernstfall ist der löschers gut zu identifizieren und schnell bei der hand.

EN fireman, the mobile signage for fire extinguishers, is perfect where fixed mounted signage is undesired such as heritage protected buildings or events of any kind. simply position the mobile signage fireman and put the extinguisher on the base. in case of emergency the extinguisher is easily located and quickly at hand.



adattatore per la sospensione dell'estintore, alluminio anodizzato color argento, regolabile in altezza, fissato con 2 viti, altezza consigliata per l'applicazione è di 800mm

adapter zum aufhängen des feuerlöschers, silber eloxiertes aluminium, höhenverstellbar, mittels 2 schrauben fixiert, empfohlene maximale höhe zur anbringung ist 800mm

adapter for the suspension of the extinguisher; silver anodized aluminium, adjustable in height, recommended maximum height for attachment is 800 mm

information

pannello di alluminio composito stampato, supporti in ottone cromato color argento satinato, profilo in alluminio anodizzato color argento, base verniciata a polvere

bedrucktes aluminiumverbund-paneel, silber-matt verchromte messing halter, silber eloxiertes aluminium profil, pulverlack-beschichtete metall basis

printed aluminium composite panel, silver matt chrome-plated supports, silver anodized aluminium profile, powder coated metal base

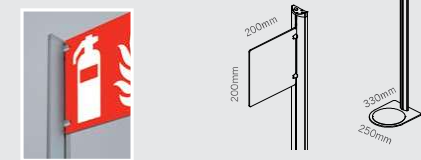

A fireman

1	FRM2100	fireman, 1pc
2	FRMHK	fireman hook, 1pc



ulteriori informazioni pag. 364
more information p. 364

signbox

IT con signbox è possibile progettare la propria segnaletica rapidamente e secondo le norme internazionali: i nostri pittogrammi corrispondono agli standard ISO, riconosciuti per legge nell'unione europea e in molti paesi in tutto il mondo. Le immagini per la sicurezza in caso d'incendio, le vie di fuga e le disposizioni di sicurezza sono degli standard in tutti gli edifici, sia nel settore pubblico, sia in quello privato. Le diverse versioni di signbox offrono simboli per le varie categorie previste dalla legge, così come immagini per le informazioni generali. Tutti i pittogrammi sono forniti come materiale grafico in diversi formati in un pratico cd.

DE mit der signbox gestalten sie ihre beschilderung schnell und gemäss international gültiger norm: wir liefern alle piktogramme gemäss ISO standard, die in der europäischen union und vielen ländern weltweit als gesetzlicher standard anerkannt sind. piktogramme für brandschutz, fluchtweg und sicherheitshinweise allgemein gehören zum standard in allen gebäuden der öffentlichen hand und der privatwirtschaft, die verschiedenen versionen von sign-box bieten jeweils symbole der gesetzlich vorgeschriebenen kategorien oder informations-piktogramme. alle symbole erhalten sie als reinzeichnung in unterschiedlichen dateiformaten auf einer praktischen cd.

EN with signbox you can design your safety signage quickly and in accordance with international standards: we provide you with all pictograms according to the ISO standard which are recognized by law in many european countries as well as worldwide. symbols for fire safety, escape routes and safety signs are part of the standard signage in all buildings in both the public and private sectors. the different versions of signbox provide you with pictograms regulated by law as well as with symbols for public information. all pictograms are saved in different file formats on the convenient cd as final artworks.



FILE FORMATS: cdr, dwg, eps, jpeg, pdf, wmf



si prega di controllare, nell'utilizzo dei pittogrammi, che le dimensioni e i colori corrispondano alle norme nazionali in vigore, in caso di differenze è necessario apportare modifiche.

bitte prüfen sie im verwendungsfall der piktogramme, dass grössenverhältnis und farbwerte immer den jeweils gültigen nationalen normen entsprechen und nehmen sie bei abweichungen die erforderlichen änderungen vor.

please check when using the symbols that size and colour correspond with the respective national standards. In case of divergence pictograms must be changed.

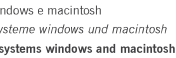
 cd per sistemi windows e macintosh
 cd für betriebssysteme windows und macintosh
 cd for operating systems windows and macintosh

D		
1	FSBOXSAFE	signbox safety signs, 1pc
2	FSBOXWATER	signbox water safety signs, 1pc
3	FSBOXINFO	signbox info signs, 1pc

advantages

- pittogrammi riconosciuti a livello internazionale secondo le norme ISO, standard previsti dalla legge in moltissimi paesi europei e del mondo.
international anerkannte piktogramme nach ISO Norm, gesetzlicher standard in vielen ländern europas und der welt
international standards according to ISO, regulated by laws in many european countries and worldwide
- download immediato e risparmio di tempo
einfacher herunterladen und zeit sparen
just download and save time
- materiale grafico per tutti i simboli nei formati comuni
reinzzeichnung aller kennzeichen in den gängigen dateiformaten
final artwork of all symbols in common file formats
- il set contiene un cd con i simboli, i segnali, una tabella in plastica con tutti i simboli, così come una brochure con tutte le immagini (informazioni per il download in lingua italiana e inglese, indicazioni sui simboli in italiano)
set enthält neben cd mit symbolen, lesezeichen, plastifizierte übersicht aller symbole sowie broschüre mit allen motiven (downloadinformation in italienischer und englischer sprache, symbolangaben in italienischer sprache)
set contains a cd with symbols, bookmark, general map with all pictograms and a brochure with all symbols (download information in italian and english, symbol details in italian)
- pittogrammi disponibili in sei diversi formati (cdr, dwg, eps, jpeg, pdf, wmf)
piktogramme in 6 verschiedenen dateiformaten (cdr, dwg, eps, jpeg, pdf, wmf)
pictograms in six different file formats (cdr, dwg, eps, jpeg, pdf, wmf)



ISO 7010 - safety signs

signbox ISO 7010 contiene i simboli principali stabiliti dalle norme per la segnaletica delle uscite di sicurezza. Le immagini per la sicurezza in caso di incendio, così come i segnali di pericolo o divieto, tutti i colori per la stampa vengono forniti con i valori pantone.

in der signbox nach ISO 7010 finden sie die wichtigsten genormten symbole für fluchtwegbeschilderung, brandschutzkennzeichnung, sowie gefahr- und gebotsschilder. alle farbwerte für den druck werden in pantone angegeben.

in the signbox ISO 7010 you find the most important standard symbols for escape ways, fire safety, hazard and mandatory signs, all colours are indicated in pantone.



ISO 20712-1 - water safety

signbox water safety comprende i simboli per la sicurezza in acqua per indicare pericolo, obblighi e divieti, secondo gli standard ISO 20712-1, per una segnaletica conforme alle regole presso porti, spiagge o aree per gli sport acquatici, tutti i colori per la stampa vengono forniti con i valori pantone.

die signbox water safety enthält symbole für gefahrhinweise, gebots- und verbotschilder der kategorie wassersicherheitszeichen, gemäß ISO 20712-1, alles für eine ordnungsgemäßen kennzeichnung von hafen- und strandbereichen, wassersportgebieten und badeanstalten. alle farbwerte für den druck werden in pantone angegeben.

the signbox water safety contains the pictograms for hazard and mandatory signs according to ISO 20712-1 that are necessary for a proper signage at ports, beaches, aquatic sport zones and public swimming baths. all colours are indicated in pantone.



ISO 7001 - public information

signbox public information, secondo lo standard ISO 7001, contiene i pittogrammi per la segnaletica e le disposizioni generali, in questo modo è possibile inserire informazioni in luoghi pubblici, per guidare visitatori, clienti e collaboratori, è lo strumento giusto per completare ogni ambiente e la componente essenziale di un perfetto sistema informativo.

mit der signbox public information nach ISO 7001 erhalten sie piktogramme für beschilderung und hinweise genereller art. so gestalten sie öffentliche bereiche informativ, damit sich besucher, kunden und mitarbeiter schnell und leicht zurechtfinden. eine wichtige ergänzung jeder einrichtung und essenzieller bestandteil eines perfekten wegweisensystems.

with signbox public information ISO 7001 we provide you with pictograms and signs not governed by specific laws, thus you can guide visitors, customers and staff, these symbols are an important part of every facility and an essential part of a perfect signage system.



metal drop

MADE IN EU controlled by KD

IT segnaletica adesiva con effetto 3D, dall'aspetto di acciaio spazzolato, resistente ai raggi UV, di lunga durata, a prova di graffio, con serigrafia a due colori, adatto ad applicazioni in ambienti con temperature da -30°C a +120°C. in fase di ordine si prega di specificare codice dell'articolo e numero del pittogramma desiderato. Le norme relative alla segnaletica di sicurezza variano da nazione a nazione. vi preghiamo quindi di verificare se i pittogrammi offerti corrispondono alle normative sulla segnaletica di sicurezza del vostro paese.

DE selbstklebende beschilderung mit 3D-linseneffekt, wirkt wie gebürsteter stahl, uv-beständig, langlebig, kraftfest, mit 2-farb siebdruck, für temperaturen von -30°C bis +120°C. bei bestellung bitte artikelcode um die nummer des gewünschten motifs ergänzen. die normen für sicherheitsbeschilderung sind national unterschiedlich. prüfen sie daher, ob das gewählte motiv ihren nationalen normen zur sicherheitsbeschilderung entspricht.

EN self-adhesive signage labels with 3D-lens-effect, looks like brushed stainless steel, uv-resistant, durable, scratch-resistant. with 2 colour silk screen print, for temperatures from -30°C up to +120°C. when ordering please complete the item code with the number of the favored symbol. as the norms for security signage differ from country to country, we ask you to check whether the symbols correspond with your national regulations.

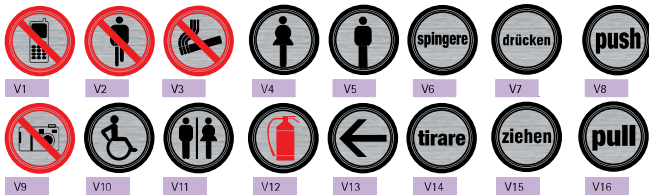

doppio effetto visivo: elegante aspetto metallico, di acciaio spazzolato, e profondità data dall'effetto 3D.

wirkt doppelt gut: im hintergrund edler metall-look und tiefenwirkung durch den 3D-linseneffekt

elegant and stylish: noble metal in the background and depth effect thanks to the 3D resin technique

information



A metal drop

1	FMD50	ø50mm, 1 pc
2	FMD100	ø100mm, 1 pc

secure drop

MADE IN EU controlled by KD

IT segnaletica adesiva con effetto 3D, resistente ai raggi UV, di lunga durata, a prova di graffio, con serigrafia a due colori, adatto ad applicazioni in ambienti con temperature da -30°C a +120°C. in fase di ordine si prega di specificare codice dell'articolo e numero del pittogramma desiderato. Le norme relative alla segnaletica di sicurezza variano da nazione a nazione. vi preghiamo quindi di verificare se i pittogrammi offerti corrispondono alle normative sulla segnaletica di sicurezza del vostro paese.

DE selbstklebende beschilderung mit 3D-linseneffekt, uv-beständig, langlebig, kraftfest, mit 2-farb siebdruck, für temperaturen von -30°C bis +120°C. bei bestellung bitte artikelcode um die nummer des gewünschten motifs ergänzen. die normen der sicherheitsbeschilderung sind national unterschiedlich. prüfen sie daher, ob diese motive ihren nationalen normen zur sicherheitsbeschilderung entsprechen.

EN self-adhesive signage labels with 3D-lens-effect, uv-resistant, durable, scratch-resistant. with 2 colour silk screen print, for temperatures from -30°C up to +120°C. in case of order please complete the item code with the number of the favored symbol. as the norms for security signage differ from country to country, we ask you to check whether the symbols correspond with your national regulations.



new standard ISO EN 7010

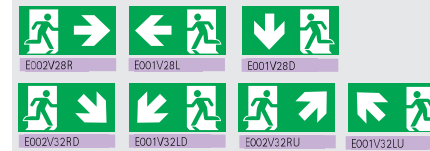
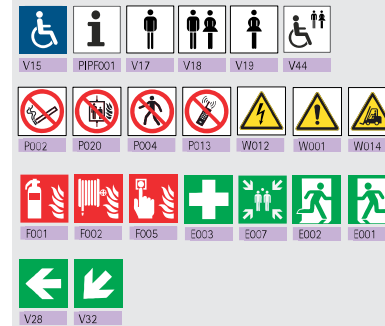

information



A secure drop

1	FSC100100	100x100mm, 1 pc	description hxb
2	FSC100200	100x200mm, 1 pc	

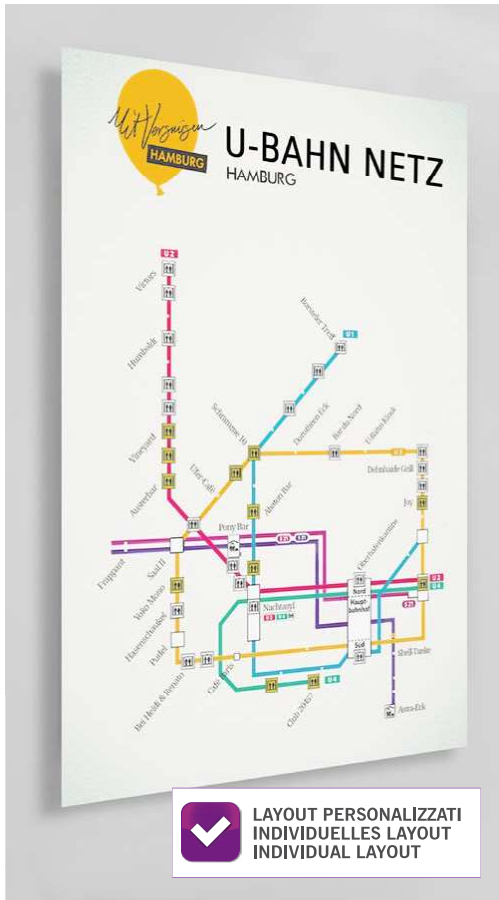

**LAYOUT PERSONALIZZATI
INDIVIDUELLES LAYOUT
INDIVIDUAL LAYOUT**

information

stampa digitale su pvc bianco flessibile, sigillato con resina trasparente, effetto 3D, utilizzo interno, nastro biadesivo incluso

digitaldruck auf flexiblem weißen pvc, versiegelt mit transparentem harz, 3D-linsenoptik, für den innenbereich, inkl. doppelkleber

digital print on flexible white pvc, sealed with transparent resin, 3D-effect, for indoor incl. double adhesive tape

nastro biadesivo, nero, con struttura in schiuma, per utilizzo interno e carico esiguo

doppelkleber, schwarz, schaumstruktur, für den innenbereich und geringe belastung

double adhesive tape, black, foam structure, for indoor and small weight

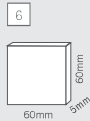

drop art

MADE IN EU design by KD

IT grazie alla stampa digitale portiamo i suoi layout personalizzati*) su pannelli in materiale plastico con verniciatura a resina, l'effetto 3D garantisce un bel risultato e i pannelli possono essere applicati su superfici lisce in interni utilizzando il nastro biadesivo, quest'ultimo, che può essere ordinato anche separatamente, è progettato per ambienti interni ed è adatto a supportare un carico esiguo.

DE mit digitaldruck realisieren wir ihr individuelles layout*) auf flexibler kunststoff-platte mit harzversiegelung, die 3D-linsenoptik sieht gut aus und kann in innenräumen auf glatten oberflächen mit doppelkleber montiert werden, wir bieten ihnen auch den doppelkleber gesondert an, der doppelkleber ist für den innenbereich und geringe belastung geeignet.

EN with digital print we realize your individual layout *) on flexible synthetic panels with resin seal, the 3D-effect looks not only great, but can be mounted indoors with double adhesive tape to all smooth surfaces, we provide you also with the double adhesive tape alone, the tape is recommended for indoor use and lean load.



nastro biadesivo nero per interni e carichi esigui

doppelkleber pads schwarz für innen und geringe belastung

double adhesive tape black for indoor use and small weights

A drop art

	description	hxb
1	DRA100100 ¹⁾ *	drop art 100x100, 1pc
2	DRA100200 ¹⁾ *	drop art 100x200, 1pc
3	DRA150150 ¹⁾ *	drop art 150x150, 1pc
4	DRAA4 ¹⁾	drop art A4, 1pc
5	DRAA3 ¹⁾	drop art A3, 1pc
6	ATP60SZ ¹⁾	doppelkleber 60x60x5, 10pc



new standard ISO EN 7010

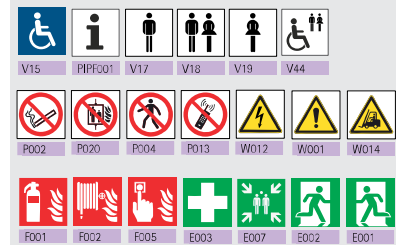

*) gli articoli 1 - 3 sono combinabili con i pittogrammi, si prega di inserire la sigla del pittogramma desiderato nello spazio bianco alla fine del codice articolo.
artikel 1 - 3 sind mit piktogrammen kombinierbar, bitte jeweilige piktogrammnr. in das weiße feld hinter dem artikelcode einfügen
the articles 1 - 3 are combinable with pictograms, please add the respective pictogram number in the white field behind the article code.

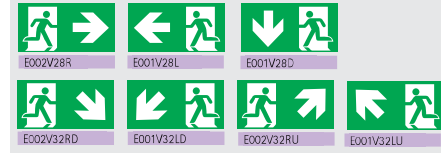



glass art wall

MADE IN EU controlled by KD

IT in accostamento alla linea standard safepix con motivi a norma, offriamo la stampa serigrafica su vetro temperato per i suoi layout personalizzati. la stampa viene coperta sul retro con uno strato bianco, stampiamo fino ad un massimo di due colori senza gradazioni (niente foto o colori particolari). il vetro di sicurezza stampato viene applicato sul nostro sistema di fissaggio a muro invisibile e sicuro pixfix o su backframe.

DE passend zur standard linie safepix mit genormten motiven, bieten wir den individuellen siebdruck hinterglas für ihr gewünschtes motiv, rückseitig wird auf den druck dann weiss hinterlegt, wir realisieren den druck mit bis zu zwei farben ohne verläufe (keine fotos und keine sonderfarben). angebracht wird das bedruckte sicherheitsglas auf der bewährten, unsichtbaren wandbefestigung pixfix oder auf backframe.

EN matching with our standard items of the safepix line with normed images, we offer you individual screen print on tempered glass for your design, the print is covered reverse with white layer. we provide the print with max. two colours without colour gradation (no foto and no special colours), the printed glass is perfectly wall mounted with our proven, invisible fixing pixfix or with backframe.

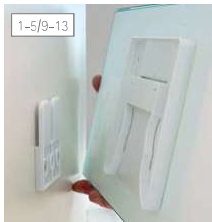

MOUNTING WITH PIXFIX

montare pixfix a parete e applicare glass art, montaggio semplice e veloce.

pixfix einfach wandmontieren und das glass art motiv einschieben, fertig.

simply wallmount pixfix and insert the glass art sign, that's it.

ulteriori informazioni pag. 457
mehr details s. more information p.

A glass art wall 1 color print

1	GARW150150C1	glassart wall 150x150mm, 1pc	
2	GARW200200C1	glassart wall 200x200mm, 1pc	
3	GARW300300C1	glassart wall 300x300mm, 1pc	
4	GARW200400C1	glassart wall 200x400mm, 1pc	
5	GARW400400C1	glassart wall 400x400mm, 1pc	
6	GARW600400C1	glassart wall 600x400mm, 1pc	
7	GARW600600C1	glassart wall 600x600mm, 1pc	
8	GARW600900C1	glassart wall 600x900mm, 1pc	

A glass art wall 2 color print

9	GARW150150C2	glassart wall 150x150mm, 1pc	
10	GARW200200C2	glassart wall 200x200mm, 1pc	
11	GARW300300C2	glassart wall 300x300mm, 1pc	
12	GARW200400C2	glassart wall 200x400mm, 1pc	
13	GARW400400C2	glassart wall 400x400mm, 1pc	
14	GARW600400C2	glassart wall 600x400mm, 1pc	
15	GARW600600C2	glassart wall 600x600mm, 1pc	
16	GARW600900C2	glassart wall 600x900mm, 1pc	

information

vetro serigrafato e temperato, fissaggio a muro invisibile in materiale plastico bianco

besiebdruktes, temperiertes glas, unsichtbare wandbefestigung aus weissem kunststoff

silk screen printed tempered glass, invisible wall fixing made of white synthetics

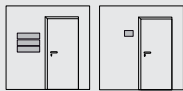

MOUNTING WITH BACKFRAME

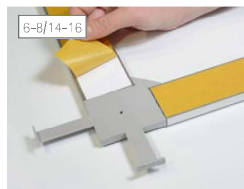

ulteriori informazioni pag. 154
mehr details s. more information p.



safepix glass

MADE IN EU design by KD

IT le offriamo anche i pittogrammi safepix su vetro temperato di sicurezza senza fissaggio posteriore, così potrà scegliere liberamente quello che preferisce. i vetri sono serigrafati nella parte posteriore, si prega di testare il fissaggio con sistemi di terzi prima dell'installazione.

DE wir bieten ihnen die safepix motive auf temperiertem sicherheitsglas auch einzeln an, sie können so die befestigung selbst auswählen, die gläser sind rückseitig besiebdruktes, befestigungen mit systemen dritter unbedingt vorab testen.

EN additionally we can provide you with the safepix images on tempered glass by itself, that way you can choose your preferred mounting system, the glass is silk screen printed on the rear side, fixing with a third party systems to be tested first.



safepix wall: montare pixfix a parete e applicarvi il motivo safepix, montaggio semplice e veloce.

safepix wall: pixfix einfach wandmontieren und das safepix motiv einschieben, fertig.

safepix wall: simply wallmount pixfix and insert the pixfix sign, that's it.

ulteriori informazioni pag. 457
mehr details s. more information p.

new standard ISO EN 7010

A safepix wall

1	SFW150150	safepix wall 150x150mm, 1pc	
2	SFW150300	safepix wall 150x300mm, 1pc	
3	SFW170370	safepix wall 170x370mm, 1pc	
4	SFW200200	safepix wall 200x200mm, 1pc	
5	SFW200400	safepix wall 200x400mm, 1pc	
6	SFW250250	safepix wall 250x250mm, 1pc	

A safepix glass

1	SFVE150150	150x150mm, 1pc	
2	SFVE150300	150x300mm, 1pc	
3	SFVE170370	170x370mm, 1pc	
4	SFVE200200	200x200mm, 1pc	
5	SFVE200400	200x400mm, 1pc	
6	SFVE250250	250x250mm, 1pc	

combinations

	386		444
	416		387



A 2
safepix flag 200x200mm
art. SPFL200200V18

information

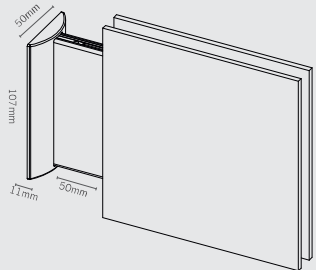

338 ulteriori informazioni pag. 338
mehr details s. 338
more information p. 338

safepix flag

MADE IN EU design by KD

IT segnaletica di sicurezza a bandiera o a soffitto realizzata in vetro temperato di sicurezza serigrafato sul retro con i più comuni pittogrammi. questo utilizzo è reso possibile dalla combinazione di fisso flag con i pannelli safepix. in fase di ordine si prega di specificare codice dell'articolo e numero del pittogramma desiderato. le norme relative alla segnaletica di sicurezza variano da nazione a nazione. vi preghiamo quindi di verificare che i pittogrammi offerti corrispondano effettivamente alle normative sulla segnaletica di sicurezza del vostro paese.

DE sicherheitsbeschilderung mit rückseitig besiedrucktem sicherheitsglas als decken- oder fahnschild. wandhalter fisso flag in kombination mit den safepix schildern machts möglich. bei bestellung bitte artikelcode um die nummer des gewünschten motifs ergänzen. die normen der sicherheitsbeschilderung sind national unterschiedlich. prüfen sie daher, ob diese motive ihren nationalen normen zur sicherheitsbeschilderung entsprechen.

EN safety signage with a silkscreen printed tempered glass as a flag or ceiling sign: wall fixing fisso flag in combination with the safepix signs. when ordering please complete the item code with the article number of the requested symbol. as the norms for security signage differ from country to country, we ask you to check whether the symbols correspond with your national regulations.

new standard ISO EN 7010

150mm 200mm
150mm 200mm

V15 P1P001 V17 V18 V19 V44
F002 P020 P004 P013 W012 W001 W014
F001 F002 F005 E003 E007 E002 E001
V28 V29 V30 V31 V32 V33 V34 V35

300mm 400mm
150mm 200mm

E002V28R E001V28L E001V28D
E002V32RD E001V32LD E002V32RU E001V32LU



C 2
safepix flag 200x200mm

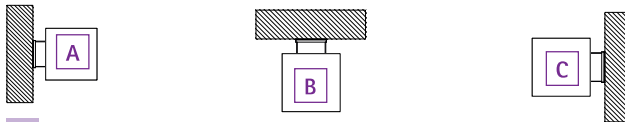

A	B	C	size*
1 SPFL150150	1 SPC150150	1 SPFR150150	150x150mm, 1pc
2 SPFL200200	2 SPC200200	2 SPFR200200	200x200mm, 1pc
3 SPFL150300	3 SPC150300	3 SPFR150300	150x300mm, 1pc
4 SPFL200400	4 SPC200400	4 SPFR200400	200x400mm, 1pc

* altezza x larghezza | höhe x breite | height x width



fisso flag

MADE IN EU design by KD

IT geniale, flessibile e multiuso: grazie a fisso flag la vostra fantasia e la vostra creatività potranno spaziare anche nell'ambito della segnaletica di sicurezza a bandiera e a soffitto. sul profilo di alluminio è possibile fissare pannelli dei più svariati materiali. grazie inoltre all'accessorio flag joint, il vostro sistema può anche diventare modulare. in questo modo anche le creazioni più complesse diventano semplici da realizzare.

DE genial, flexibel, vielfältig: mit fisso flag können sie richtig kreativ werden bei decken- und fahnenbeschreibungen. auf das aluminiumprofil befestigen sie paneele unterschiedlichster materialien. mit dem flag joint wird das ganze dann modular erweitert. so lassen sich unterschiedlichste anforderungen ganz einfach realisieren.

EN smart, flexible and versatile: with fisso flag new creative ways for the flag and ceiling signage will open up for you. panels of all kinds of materials are fixed to the aluminium profile directly. with the flag joint the system extends modularly. thus you will easily implement systems of all sorts.



alluminio anodizzato color argento, zamac in color argento satinato, materiale sintetico color grigio satinato

silber eloxiertes aluminium, silbermatt verchromter metalldruckguss, silber-grauer kunststoff

silver anodised aluminium, silver matt chromed metal die cast, silver grey plastic

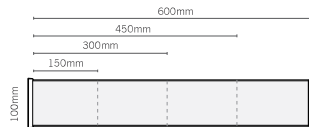

alluminio anodizzato color argento, zamac in color argento satinato

silber eloxiertes aluminium, silbermatt verchromter metalldruckguss

silver anodised aluminium, silver matt chromed metal die cast



information

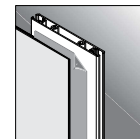
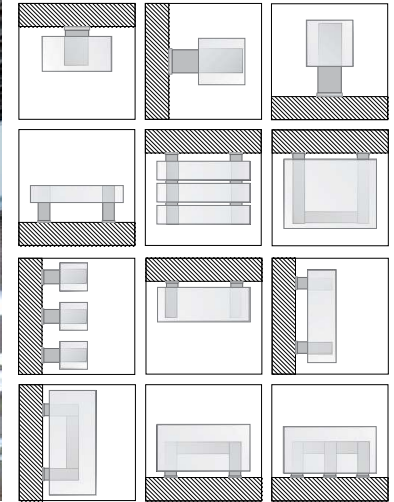
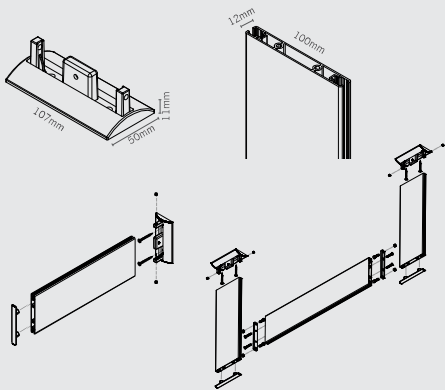

biadesivo
doppelsebkleber
double sided tape

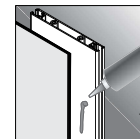

silicone o colla
silikon oder flüssigkleber
silicone or glue

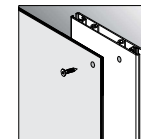

viti
schrauben
screws

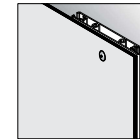

rivetti
nieten
rivets

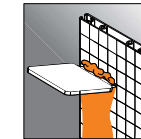

serigrafia
siebdruck
silk screen print

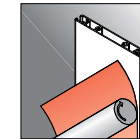

stampa digitale laminata
digitaldruck aufkaschieren
laminated digital print



personalizzabile
personalisierbar
customizable

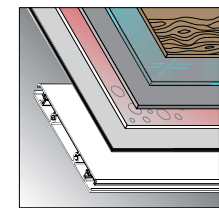

assemble with:
wood
glass
metal
synthetic
aluminium composite panels

A fisso flag

1	FFG150	fisso flag 150mm, 1pc
2	FFG300	fisso flag 300mm, 1pc
3	FFG450	fisso flag 450mm, 1pc
4	FFG600	fisso flag 600mm, 1pc
5	FFJ300	fisso flag joint 300mm, 1pc
6	FFJ450	fisso flag joint 450mm, 1pc
7	FFJ600	fisso flag joint 600mm, 1pc
8	FFJ900	fisso flag joint 900mm, 1pc



2 magneto sign 150x300mm

magneto sign

MADE IN EU design by KD

IT pratico e attraente: grazie al sistema magnetico invisibile potrà cambiare i pannelli magneto sign in ogni momento, velocemente e senza attrezzi. il bordo stretto e la fuga d'ombra della cornice donano al sistema un look perfetto sia per ambienti esterni che interni. magneto sign può essere montato a muro sia orizzontalmente che verticalmente.

DE anziehend praktisch: mit magnet unsichtbar befestigt lassen sich die magneto sign paneel jederzeit ohne werkzeug ganz leicht und schnell austauschen. der schmale rand und die schattenfuge des rahmens ergeben den perfekten look für den innen- und geschützten außenbereich. magneto sign empfiehlt sich für die wandmontage horizontal oder vertikal.

EN attracting convenience: invisibly mounted with magnet the magneto sign panels can be exchanged anytime without tool quickly. the lean edge and the shadow gap of the frame provide a perfect look for interior and protected outdoor signage. magneto sign is recommended for wall mounting horizontally and vertically.

advantages

- ✓ fissaggio e connettori angoli invisibili
unsichtbare befestigung und eckverbinder
invisible fixing and edge connector
- ✓ bordo sottile della stampa
schmale druckumrandung
lean frame of the print
- ✓ cambio del pannello veloce e senza attrezzi
paneel ohne werkzeug schnell ausgetauscht
panel quickly exchanged without tool
- ✓ fuga d'ombra
schattenfuge
shadow gap

information

profilo in alluminio anodizzato color argento, connettori angoli invisibili, pannello in alluminio laccato bianco, strisce magnetiche: sulla cornice sono pre-montate, sul pannello andranno applicate dopo la stampa

silbermatt eloxiertes aluminium profil, unsichtbare eckverbinder, weissmatt lackiertes alu-paneel, magnetstreifen am rahmen vormontiert, für paneel lose zur montage nach bedruckung

silver matt anodized aluminium profile, invisible corner connectors, white matt varnished aluminium panel, magnetic strips pre-assembled with frame, loose for diy panel mount after print

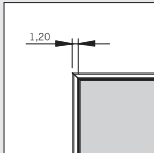
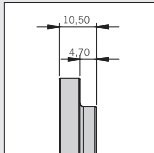

A magneto sign

description hxb

1	MNTW150150	imagneto sign 150x150, 1 pc	
2	MNTW150300	magneto sign 150x300, 1 pc	
3	MNTW200200	magneto sign 200x200, 1 pc	
4	MNTWA4	magneto sign A4, 1 pc	
5	MNTWA3	magneto sign A3, 1 pc	
6	MNTW200400	magneto sign 200x400, 1 pc	
7	MNTW400600	magneto sign 400x600, 1 pc	
8	MNTW600900	magneto sign 600x900, 1 pc	

altre misure su richiesta | weitere maße auf anfrage | other sizes on request



8 magneto sign 600x900mm

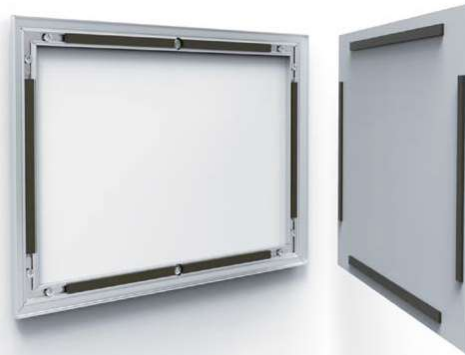

le strisce magnetiche fermano il pannello, sulla cornice sono pre-montate, sul pannello andranno applicate dopo la stampa

magnetstreifen halten das paneel, am rahmen bereits vormontiert, am paneel montieren sie die magnetstreifen nach dem druck

magnetic strips hold the panel in place, the strips are already mounted to the frame, at the panel you mount the strips after print.





14
glassnox A3 vertical

information

cornice in acciaio inox spazzolato con sistema ad incastro a molla, pannello d'alluminio verniciato color bianco, spessore cornice 8mm

rahmen aus gebürstetem edelstahl mit spannfeder, aluminiumpaneel weiss lackiert, rahmenstärke 8mm

brushed stainless steel frame with spring-loaded system, white coated aluminium panel, frame thickness 8mm

lastra in acrilico color blu cristallino o vetro temperato
frontscheibe aus kristallblauem acrylglas oder temperiertem glas
front cover made of crystal blue acrylic or tempered glass

discreta distanza dal parete grazie al supporto
fissaggio in materiale plastico

elegante schattenfuge durch montagepaneel aus kunststoff

elegant shadow gap thanks to the synthetic mounting support

minuteria per il montaggio a parete incl.
montagematerial für die wandbefestigung incl.
wallmounting material incl.

glassnox

MADE IN EU design by KD

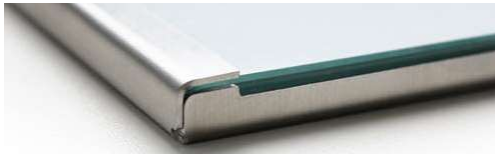

IT grazie al disegno intelligente l'informazione può essere cambiata in modo semplice e veloce. basta spingere la protezione in acrilico color blu cristallino o in vetro temperato in alto per aprire la cornice. la cornice extra piatta in acciaio inox spazzolato rende elegante qualsiasi presentazione. tutti i prodotti glassnox possono essere fissati su le superfici lisce con il biadesivo speciale. glassnox è ideale per la segnaletica interna per porte o piani o come porta informazioni.

DE dank des cleveren designs ist jede einzelblattinfo schnell und einfach zu wechseln. die abdeckungen aus kristallblauem acrylglas oder temperiertem glas werden zum öffnen einfach nach oben geschoben. der extra flache und schlanke rahmen aus gebürstetem edelstahl gibt jeder präsentation den richtigen rahmen. alle glassnox produkte können auch mit speziellem doppelkleber auf glatten oberflächen befestigt werden. glassnox ist ideal für die elegante tür- und etagenbeschilderung oder häufig wechselnde information.

EN thanks to its clever design every information can be exchanged quickly and easily. the covers made of crystal blue acrylic or tempered glass are simply pushed upwards to open the frame. the extra flat frame in brushed stainless steel gives your presentation a trendy look. all glassnox products can be also mounted with special adhesive tape to smooth surfaces. glassnox is perfect for the elegant signage as well as for the frequent exchangeable information.

A glassnox poster size hxb

	poster size	hxb		
1	GLNR10574SY	105x74mm	A7 vertical, acrylic, 1pc	
2	GLNR148105SY	148x105mm	A6 vertical, acrylic, 1pc	
3	GLN148148SY	148x148mm	acrylic, 1pc	
4	GLNR148210SY	148x210mm	A5 horizontal, acrylic, 1pc	
5	GLNR148297SY	148x297mm	acrylic, 1pc	
6	GLNR148594SY	148x594mm	acrylic, 1pc	
7	GLNR210148SY	210x148mm	A5 vertical, acrylic, 1pc	
8	GLN210210SY	210x210mm	acrylic, 1pc	
9	GLNR210297SY	210x297mm	A4 horizontal, acrylic, 1pc	
10	GLNR210420SY	210x420mm	acrylic, 1pc	
11	GLNR297210SY	297x210mm	A4 vertical, acrylic, 1pc	
12	GLN297297SY	297x297mm	acrylic, 1pc	
13	GLNR297420SY	297x420mm	A3 horizontal, acrylic, 1pc	
14	GLNR420297SY	420x297mm	A3 vertical, acrylic, 1pc	
15	GLNR594420GL	594x420mm	A2 vertical, glass, 1pc	
16	GLNR841594GL	841x594mm	A1 vertical, glass, 1pc	
17	GLNR148800SY	148x800mm	acrylic, 1pc	
18	GLNR700500GL	700x500mm	glass, 1pc	
19	GLNAD		double-sided tape, 10pcs	

* altezza x larghezza | höhe x breite | height x width



print not included

advantages

- ✓ materiali durevoli e di alta qualità: acciaio inox, acrilico/vetro
langlebige und hochwertige materialien: edelstahl, acrylglas
long living and durable materials: stainless steel, acrylic/glass
- ✓ sempre moderno e nobile: inserisce perfettamente in qualsiasi ambiente
zeitlos und edel: passt in jedes ambiente
timeless and classy: suitable for every ambience
- ✓ sistema a molla integrato: cambio delle informazioni semplice e rapida
spannfeder-system: einfacher und schneller infoaustausch
tension spring system: easy and quick information exchange
- ✓ elegante distanza dal muro: look elegante e aspetto moderno
schattenfuge: elegante optik und hochwertiger look
shadow gap: elegant look and trendy design
- ✓ flessibile: configurare il layout e stampare direttamente su carta
flexibel: information selbst gestalten und einfach ausdrucken
flexible: design the layout and simply print on paper

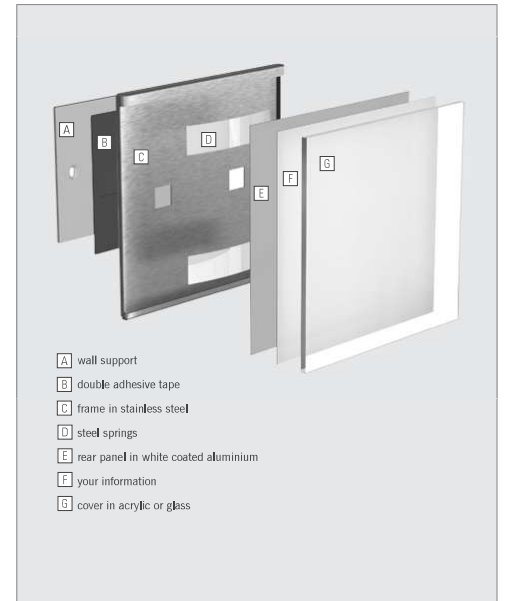

- A wall support
- B double adhesive tape
- C frame in stainless steel
- D steel springs
- E rear panel in white coated aluminium
- F your information
- G cover in acrylic or glass



18
glassnox 700x500 vertical

MOUNTING WITH BACKFRAME



ulteriori informazioni pag. 154
mehr details s. 154
more information p. 154

per il montaggio su superfici lisce in-dichiamo nostro biadesivo speciale
für die montage auf glatten oberflächen empfehlen wir unseren speziellen doppelkleber
for mounting to smooth surfaces we provide you with our special adhesive tape

create e stampate il layout semplicemente con il pc
layout am eigenen pc gestalten und ausdrucken
design and print with your own workstation

SIGNCODE PAPER pag. 317



pratico: inserto cartaceo prefustellato per la personalizzazione, carta in formato A4, inserto centrale prefustellato, 148x148mm.
praktisch: vorgestanzte papier einleger zum selber drucken: A4 format mit mittig vorgestanztem einleger 148x148mm.
convenient: pre-cut paper inlay for customizing with print: A4 format with center pre-cut inlay in size 148x148mm.



spingere leggermente la protezione e farla scorrere verso l'alto per aprire la cornice
zum öffnen scheibe leicht andrücken, nach oben schieben und herausnehmen
push to open gently the cover, slide it upwards and then take it out

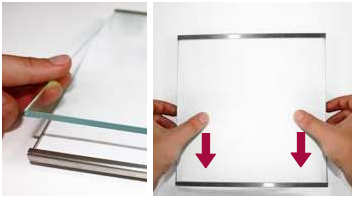

inserire l'informazione, spingere leggermente la lastra e farla scorrere verso il basso per chiudere la cornice
information einlegen, zum schließen scheibe leicht andrücken und nach unten schieben, bis sie wieder einrastet
insert the paper, push the cover gently to close downwards until it locks again into place

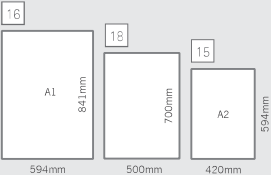

16 A1 841mm 594mm
18 700mm 500mm
15 A2 594mm 420mm

il fissaggio di questi formati avviene con il nostro sistema backframe
diese formate müssen mit backframe befestigt werden
to fix these formats please use our system backframe



distanza dalla parete: ca. 20mm
wandabstand: ca. 20mm
distance from wall: about 20mm

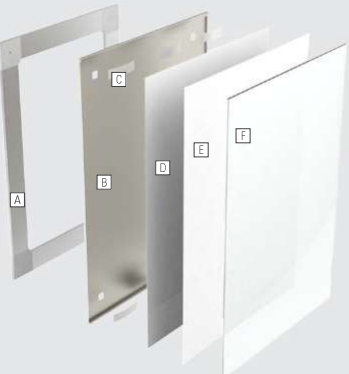

- A backframe wall support
- B frame in stainless steel
- C steel springs
- D rear panel in white coated aluminium
- E your information
- F glass



11
glassnox A4 vertical



3
glassnox 148x148mm



4
glassnox A5 horizontal



glassnox flag

MADE IN EU design by KD

IT la segnaletica moderna glassnox è disponibile anche a bandiera per il semplice montaggio a parete. anche glassnox flag garantisce un semplice e veloce cambio delle informazioni: per aprire la cornice basta premere e spingere la protezione verso l'alto, una cornice piatta, moderna e in acciaio inox. adatta per ogni ambiente moderno!

DE die moderne glassnox beschilderung gibt es auch als flaggenschild für die einfache wandmontage. auch glassnox flag garantiert einen einfachen und schnellen informationswechsel: einfach abdeckung zum öffnen nach oben schieben. der flache und elegante edelstahl-rahmen passt in jedes moderne ambiente.

EN the modern signage system glassnox is available also as a flag or ceiling sign. also glassnox flag guarantees easy and quick information exchange: the covers made of acrylic or tempered glass are simply pushed upwards to open the frame. the extra flat and modern stainless steel frame fits perfect into every modern ambience.



create e stampate il layout semplicemente con il pc
 layout am eigenen pc gestalten und ausdrucken
design and print with your own workstation

information

cornice in acciaio inox spazzolato con sistema ad incastro a molla, pannello d'alluminio verniciato color bianco, spessore cornice 8mm

rahmen aus gebürstetem edelstahl mit spannfeder, aluminiumpaneel weiss lackiert, rahmenstärke 8mm

brushed stainless steel frame with spring-loaded system, white coated aluminium panel, frame thickness 8mm

lastra in acrilico color blu cristallino o vetro temperato
 frontscheibe aus kristallblauem acrylglas oder temperiertem glas
 front cover made of crystal blue acrylic or tempered glass

discreta distanza dal parete grazie al supporto
 fissaggio in materiale plastica

elegante schattenfuge durch montagepaneel aus kunststoff

elegant shadow gap thanks to the synthetic mounting support

minuteria per il montaggio a parete incl.
 montage-material für die wandbefestigung incl.
wallmounting material incl.

A	glassnox flag	description hxb
1	GLNF148148SY	glassnox flag 148x148mm, 1pc
2	GLNF210210SY	glassnox flag 210x210mm, 1pc
3	GLNF210297SY	glassnox flag 210x297mm, 1pc



glassnox suspension

MADE IN EU design by KD

IT montabile sia a parete, a bandiera che a soffitto: con glassnox suspension la famiglia glassnox è completa, per aprire la cornice basta premere e spingere la protezione verso l'alto. una cornice piatta, moderna e in acciaio inox. adatta per ogni ambiente moderno!

DE ob für wand, als fahnen- oder deckenschild: die glassnox familie ist mit glassnox suspension komplett und ihrer modernen gebäudebeschilderung steht nichts im wege.

EN wall, flag or suspension: glassnox suspension completes the range of glassnox products. now nothing stands in your way when it comes to a modern signage system for buildings.



create e stampate il layout semplicemente con il pc
 layout am eigenen pc gestalten und ausdrucken
design and print with your own workstation

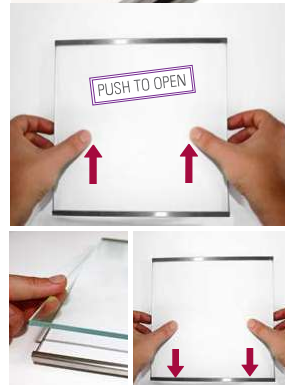

A	glassnox suspension	description hxb
1	GLNS148594SY	glassnox suspension 148x594, 1pc
2	GLNS148800SY	glassnox suspension 148x800, 1pc



information

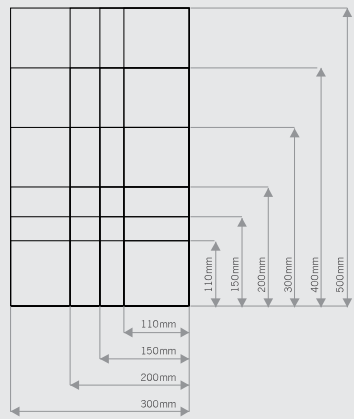

printosign

MADE IN EU design by KD

IT Le targhe printosign sono in alluminio anodizzato color argento, hanno uno spessore di 3mm, presentano gli angoli arrotondati e i bordi smussati. printosign si può personalizzare su entrambi i lati, con una stampa diretta o con un laminato. vi offriamo le targhe printosign in molti dei formati più comuni, da fissare a parete con pixif o con il resistente ma removibile biadesivo a peduncoli plastici. entrambe le soluzioni sono semplici e veloci da montare.

DE printosign-schilder sind aus 3mm starkem silber eloxiertem aluminium mit abgerundeten ecken und gefasteten kanten. sie können beidseitig mit direktdruck oder aufkaschieren personalisiert werden. wir bieten ihnen die printosign-schilder in vielen gängigen formaten zur wandbefestigung mit pixif oder stark haftendem, wieder lösbarem pilzkopfband an. beide systeme sind einfach und schnell zu montieren.

EN printosign panels are made of 3mm thick silver anodized aluminium with rounded corners and beveled edges. you can customize them on both sides with digital prints or laminates. we offer the printosign panels in many common sizes for wall mounting with pixif or removable mushroom head adhesive tape. both systems are quickly and easily mounted to the wall.



personalizzabile
personalisierbar
customizable



attaccare printosign al pixif con il biadesivo e poi inserirlo nel supporto montato a parete; facile da cambiare in qualsiasi momento.

printosign mit doppelkleber auf pixif fixieren und dann einfach auf die wandmontierte halterung schieben, jederzeit abnehmbar

glue printosign to the pixif and then simply click it to the wallmounted pixif wall support, removable anytime



montaggio a parete su superfici lisce con biadesivo a peduncoli plastici; l'applicazione non prevede fori.

befestigung mit starkhaftendem pilzkopf-doppelklebeband, ohne bohrung für glatte oberflächen

mushroom head adhesive tape allows the quick mounting to smooth surfaces without the need for drilling holes

A printosign

		size*		size*
a	1	FTSP110110AL ¹⁾	110x110mm	FTSV110110AL ¹⁾
	2	FTSP110200AL ¹⁾	110x200mm	FTSV110200AL ¹⁾
	3	FTSP110300AL ¹⁾	110x300mm	FTSV110300AL ¹⁾
	4	FTSP110400AL ¹⁾	110x400mm	FTSV110400AL ¹⁾
	5	FTSP110500AL ¹⁾	110x500mm	FTSV110500AL ¹⁾
	6	FTSP150150AL	150x150mm	FTSV150150AL
	7	FTSP150200AL	150x200mm	FTSV150200AL
	8	FTSP150300AL	150x300mm	FTSV150300AL
	9	FTSP150400AL ¹⁾	150x400mm	FTSV150400AL ¹⁾
	10	FTSP150500AL	150x500mm	FTSV150500AL
	11	FTSP200200AL	200x200mm	FTSV200200AL
	12	FTSP200300AL	200x300mm	FTSV200300AL
	13	FTSP200400AL ¹⁾	200x400mm	FTSV200400AL ¹⁾
	14	FTSP200500AL	200x500mm	FTSV200500AL
	15	FTSP300300AL	300x300mm	FTSV300300AL
	16	FTSP300400AL	300x400mm	FTSV300400AL
	17	FTSP300500AL	300x500mm	FTSV300500AL

* altezza x larghezza | höhe x breite | height x width ¹⁾ fino ad esaurimento scorte | solange vorrat reicht | while stock last

badgetec® MADE IN EU controlled by KD



robusto badge piatto in materiale plastico con chiusura magnetica.

robustes, flaches kunststoffschild mit integriertem kraftmagnet.

robust, flat badge with integrated strong magnet.

raffinato ed armonioso grazie al fissaggio magnetico e alla forma leggermente arrotondata.

passt sich durch die integrierte magnetbefestigung und leichte rundung harmonisch an.

thanks to the integrated magnet and its rounded shape the polar matches perfectly with every look.

badge leggero e tridimensionale grazie alla nuova tecnica di chiusura, fissaggio a spillo.

dreidimensionales, leichtes schild dank neuartiger klapp-technik, befestigung mit nadel.

lightweight three-dimensional badge with folding technique. attached with a safety pin.

badgetec® A

		size*
1	BPEV40TR	event 40, 37x75mm, 1 pc
2	BPEV60TR	event 60, 54x85mm, 1 pc
3	BPOF40AR	office „classic“, 37x75mm, 1 pc
4	BPPO35AR	polar® „metal“, 34x74mm, 1 pc

* altezza x larghezza | höhe x breite | height x width

printbadge MADE IN CHINA quality control by KD

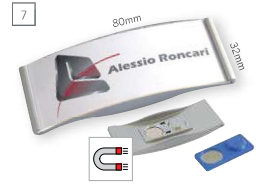
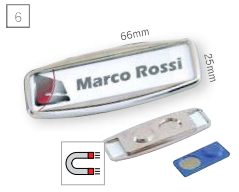

il badge squisitamente trendy in pregiato materiale sintetico nichelato e con efficace fissaggio magnetico.

trendiger badge in hochwertig vernickeltem kunststoff mit extra starker magnetbefestigung.

trendy badge in high-grade nickel-plated finish with extra strong magnetic fastening.

di aspetto elegante, in materiale sintetico metallizzato argento, a fissaggio magnetico particolarmente efficace.

elegante optik in kunststoff silbermetallisch mit sicherer extra starker magnetbefestigung.

elegant look in silver metal with safe extra strong magnetic fastening.

di formato avvincente, in materiale sintetico argentato, a fissaggio magnetico particolarmente efficace.

ansprechendes format in kunststoff silber mit extra starker magnetbefestigung.

appealing format in silver with extra strong magnetic fastening.



printbadge small/medium/large A

6	PRB6315NI *	nickel-plated, 15x62mm, 1 pc
7	PRB7832AR *	silver, 32x75mm, 1 pc
8	PRB7537AR *	silver, 37x75mm, 1 pc

* nessuna distribuzione in e verso la germania | kein vertrieb in und nach deutschland | no distribution in or towards germany

* altezza x larghezza | höhe x breite | height x width

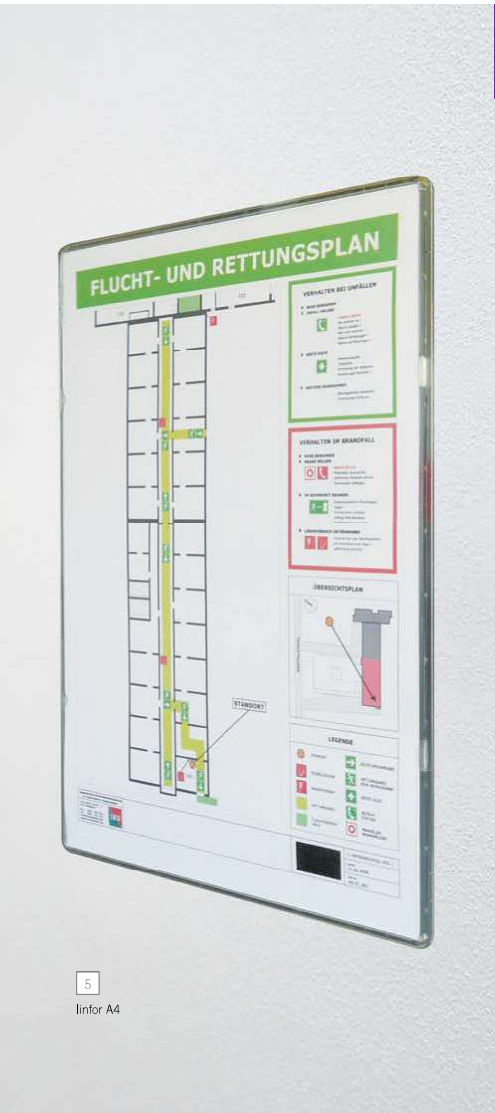

5 Linfor A4

linfor MADE IN EU design by KD

IT leggero di aspetto e di peso, linfor è la soluzione più conveniente e veloce per l'esposizione di fogli singoli, in particolare per applicazioni su superfici lisce, materiale plastico stampato ad iniezione, foglio protettivo flessibile e biadesivo trasparente: per una garanzia di tenuta, uniformità delle dimensioni ed un cambio veloce delle informazioni, linfor è disponibile nei formati DIN più comuni.

DE schlank in optik und gewicht ist linfor die günstige und schnelle einzelblatt präsentation v.a. für montage auf glatten oberflächen, kunststoff-spritzguss mit flexibler cover-folie und transparentem doppelkleber garantieren masstreue und unkompliziertes auswechseln, erhältlich ist linfor in den gängigen DIN formaten.

EN lean design and light weight characterize linfor, the perfect low budget information presenter. it is best for mounting on smooth surface like glass, plastic die-cast with flexible cover sheet and transparent double adhesive tape guarantee accurate dimensions and easy exchange. linfor is available in the most common DIN formats.

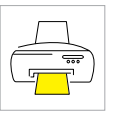

alti colori pag. mehr farben s. more colours p.

12

information

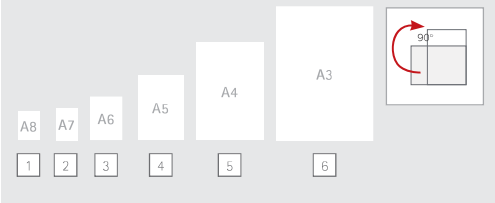

A linfor

1	LINFORA8TR	linfor A8 transparent, 1 pc
2	LINFORA7TR	linfor A7 transparent, 1 pc
3	LINFORA6TR	linfor A6 transparent, 1 pc
4	LINFORA5TR	linfor A5 transparent, 1 pc
5	LINFORA4TR	linfor A4 transparent, 1 pc
6	LINFORA3TR	linfor A3 transparent, 1 pc



2
smartquick 150x150



1
smartquick 105x150

smartquick

MADE IN EU design by KD

information

polycarbonato stampato a pressofusione:
copertura trasparente e retro color bianco

polycarbonat-spritzguss: cover transparent,
rückwand weiss

die-cast polycarbonate: cover transparent,
rear part white

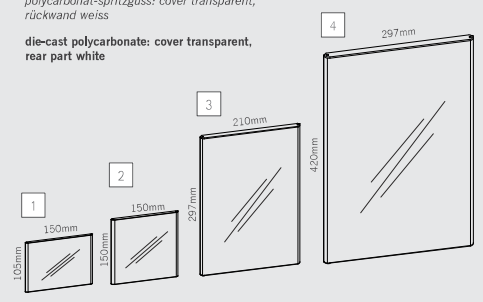

fissaggio con nastro
biadesivo
montage mit doppelkleber
mounting with double
adhesive tape

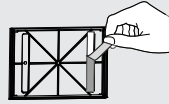

fissaggio con viti
montage mit schrauben
mounting with screws

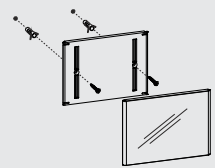

IT semplice, pratico e veloce da montare. smartquick è un portainformazioni in polycarbonato stampato a pressofusione e si monta molto facilmente: potrà utilizzare viti, tasselli oppure, in caso di superfici lisce come il vetro, un nastro biadesivo. smartquick può essere utilizzato ovunque voglia esporre informazioni senza cornice proteggendole dalla polvere. la cover può essere aperta sia da destra che da sinistra. il retro è bianco e dona un perfetto sfondo alla sua informazione.

DE klein, praktisch und schnell montiert: unser smartquick aus hochwertigem polycarbonat spritzguss lässt sich einfach und schnell wandmontieren. ob mit schraube und dübel oder doppelkleber auf glatten oberflächen, der smartquick ist überall dort im einsatz, wo sie informationen rahmenlos und staubgeschützt präsentieren wollen. zum austausch öffnet sich das transparente cover nach links oder rechts, die rückwand ist weiss und bildet den perfekten hintergrund für ihre information.

EN small, convenient and quickly mounted: our smartquick made of high-grade die-cast polycarbonate. it is easily wall mounted with screws but you can attach it also to smooth surfaces such as glass with the double sided adhesive tapes provided. smartquick is perfect when you want to display information framelessly and dust-proof. to exchange your information simply click open the transparent cover to the left or to the right, the rear part is white in colour, making the perfect background for your information.

A	smartquick	description hxb
1	SMQ105150WH	smartquick 105x150mm, 1 pc
2	SMQ150150WH	smartquick 150x150mm, 1 pc
3	SMQA4WH	smartquick A4, 1 pc
4	SMQA3WH	smartquick A3, 1 pc

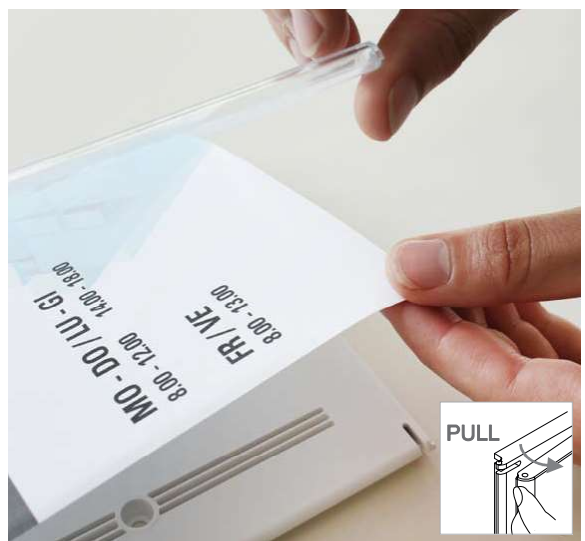

scatole, eleganti e di semplice montaggio
cambio veloce dell'informazione
schmale, elegante optik - schnell
montiert, leicht ausgetauscht
slim, elegant look and easily mounted,
info quickly exchanged



4
smartquick A3



3
smartquick A4

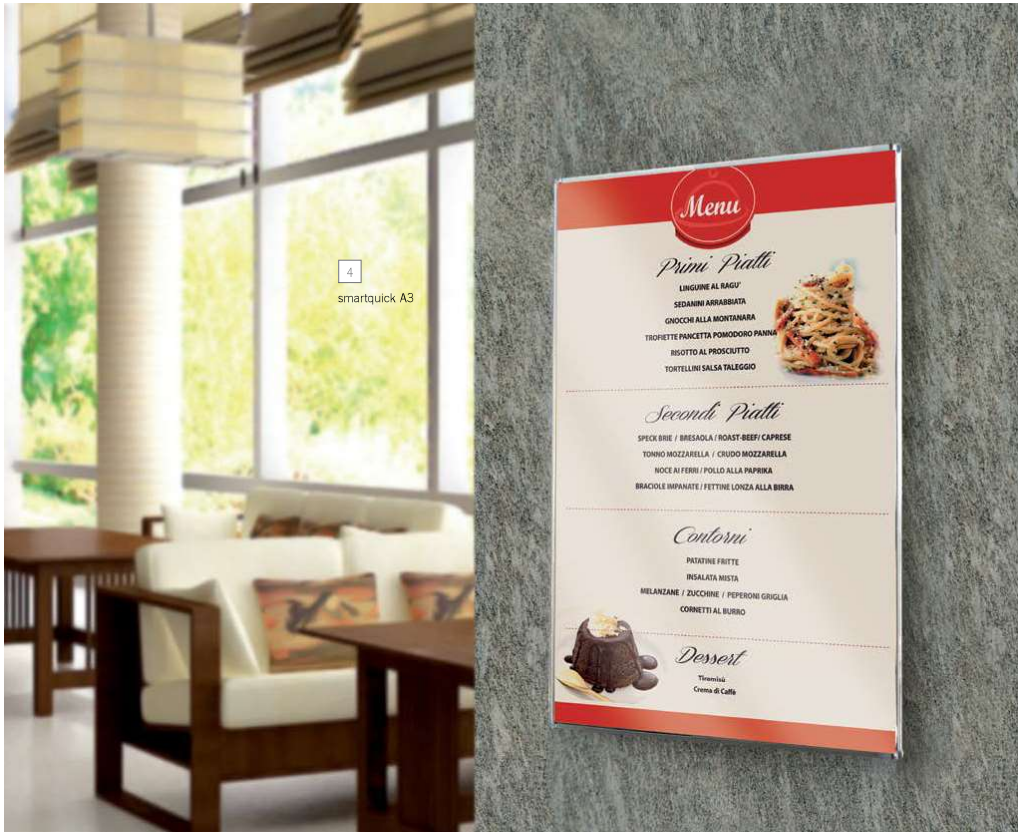

4
smartquick A3



- advantages**
- ✓ look senza cornice, soluzione impenetrabile alla polvere
rahmenlos und staubgeschützt
frameless and dust proof
 - ✓ montaggio a muro con viti, su superfici lisce con nastro biadesivo
für wand mit schrauben, für glatte oberflächen mit doppelkleber
wall mount with screws, on smooth surfaces with double adhesive tape
 - ✓ cambio delle informazioni semplice e veloce
schneller, einfacher info-tausch
quick and easy exchange of information
 - ✓ policarbonato di alta qualità
hochwertiges polycarbonat
high-grade polycarbonate

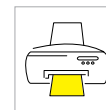

layout realizzabile e stampabile con un semplice pc
layout am eigenen pc gestalten und ausdrucken
design and print with your own workstation



3
pixquick A6 large

pixquick®

MADE IN EU design by KD patented

IT pixquick è ideale come espositore da banco o da parete, è a prova di polvere e non ha cornici laterali che impediscano la corretta visione dell'informazione, ideale soprattutto proprio per quelle informazioni che debbano essere cambiate frequentemente. pixquick si può aprire da entrambi i lati, semplicemente spostando il pannello frontale o togliendolo completamente: basta una leggera pressione sugli angoli. policarbonato di alta qualità ed un processo produttivo moderno e tecnologico garantiscono al prodotto design, durata di vita notevole, uniformità delle dimensioni ed un aspetto decisamente gradevole, particolarmente elegante si presenta pixquick silver con il retro verniciato di color argento metallizzato.

DE pixquick als funktioneller thekenaufsteller oder als wanddisplay präsentiert optimal häufig zu wechselnde info, rahmenlos und staubgeschützt. zum öffnen kann das frontpaneel nach beiden seiten aufgeklappt oder komplett abgenommen werden, ein einfacher druck auf die ecken genügt. hochwertiges polycarbonat und produktionsverfahren nach dem letzten stand der technik garantieren ein langlebiges designprodukt mit masstreue und perfekter optik. besonders elegant und hochwertig wirkt pixquick silver mit seiner silbermetallisch lackierten rückseite.

EN pixquick is a perfectly functional frameless and dust proof counter or wall display, ideal for information that has to be changed frequently, the front panel can be opened in either direction or removed completely by simply pushing the corners. high grade polycarbonate and a state-of-the-art production process guarantees a long-lasting design product with constant size and a perfect look. pixquick silver is especially elegant with its metallic silver coated rear part.



6
pixquick A3



information

per aprire sganciare o rimuovere il pannello frontale - A3 solo rimuovere completamente zum öffnen frontpaneel aufklappen oder abnehmen - A3 frontpaneel nur komplett abnehmbar



to open: expand or remove front panel - A3 front panel only remove

girare pixquick per cambiare facilmente formato da orizzontale a verticale e viceversa



im handumdrehen von vertikal auf horizontal umstellen

just rotate for vertical or horizontal position

possibilità di diversi gradi di inclinazione cambiando la posizione del supporto da tavolo



verschiedene neigungen möglich durch verstellen der stütze

different inclinations by changing the support

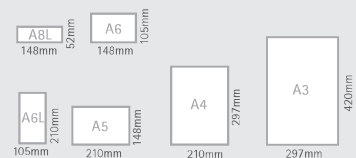

ulteriori informazioni pag. mehr details s. more information p. 6-9

A pixquick a

1	PQA8L	pixquick A8L without support, 1pc	
2	PQA6 *	pixquick A6, 1pc	
3	PQA6L *	pixquick A6L, 1pc	
4	PQA5	pixquick A5 incl. support, 1pc	
5	PQA4	pixquick A4 incl. support, 1pc	
6	PQA3	pixquick A3, 1pc	

7 PQSA6PL support for A6 and A6 large, 1pc

* ordinare supporto PQSA6PL a parte | stütze PQSA6PL extra bestellen | order support PQSA6PL extra

A pixquick silver b

8	PQARA8L	pixquick silver A8L, 1pc	
9	PQARA6	pixquick silver A6, 1pc	
10	PQARA6L	pixquick silver A6L, 1pc	
11	PQARA5	pixquick silver A5, 1pc	
12	PQARA4	pixquick silver A4, 1pc	
13	PQARA3	pixquick silver A3, 1pc	

a



1-6
pixquick realizzato con stampa ad iniezione in polycarbonato trasparente
pixquick in transparentem polycarbonat-spritzguss
pixquick in transparent die cast polycarbonate

b



8-13
pixquick realizzato con stampa ad iniezione in polycarbonato trasparente, retro verniciato color argento
pixquick in transparentem polycarbonat-spritzguss, rücksseite silber lackiert
pixquick in transparent die cast polycarbonate, rear part varnished silver

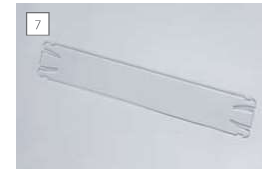

7
supporto da banco per formati A6 e A6L in PETG
stütze in PETG für format A6 und A6L
support for A6 and A6L made of PETG





1
pixquick wall 105x600mm



4
pixquick flag A4

pixquick® flag

MADE IN EU design by KD

IT pixquick flag è il nuovo sistema di segnaletica bifacciale a bandiera, che mantiene ed esalta tutte le caratteristiche proprie della linea pixquick: l'informazione può essere stampata semplicemente anche su carta, introdotta nel pixquick e sostituita in qualsiasi momento. Il pixquick flag è disponibile in diversi formati. Il sistema di aggancio a muro, realizzato in metallo pressofuso color argento satinato, garantisce un fissaggio sicuro al prodotto, segnaletica pixquick: la migliore scelta per un sistema di guida semplicemente flessibile.

DE das doppelseitige auslegerschild der pixquick signage serie überzeugt mit allen vorteilen der pixquick reihe: die information wird einfach ausgedruckt und kann jederzeit schnell ausgetauscht werden. erhältlich ist der pixquick flag in vielen formaten. der hochwertige wandhalter aus silbermattem metall-druckguss hält den pixquick flag sicher an der wand. pixquick signage: ihre wahl für ein durchgängig gestaltetes äusserst flexibles wegweitsystem.

EN the double-side flag sign of the pixquick signage series convinces with all the advantages of the pixquick design: the information can be easily printed on paper and can be exchanged anytime. the pixquick flag is available in many different sizes. the high-grade wall support made of silver matt die-cast metal mounts the pixquick flag safely to the wall. pixquick signage: your choice for a consistently designed yet very flexible signage system.

pixquick® wall

MADE IN EU design by KD

IT in linea con la nuova serie di segnaletica pixquick, il nuovo formato da parete. l'informazione viene presentata senza cornici laterali, protetta dalla polvere e sarà facile sostituirla in qualsiasi momento. questo formato è particolarmente indicato per sistemi di segnaletica di direzione in edifici pubblici e grandi strutture, dove le indicazioni e le direzioni devono essere perfettamente visibili anche ad una certa distanza. il sistema pixquick è flessibile: le informazioni stampate su carta sono velocemente e semplicemente intercambiabili.

DE passend zur pixquick signage serie das neue maß für die wand: rahmenlos und staubgeschützt wird die information präsentiert und kann jederzeit leicht ausgetauscht werden. besonders geeignet ist dieses mass für leitssysteme in öffentlichen gebäuden und großen strukturen wo wegweiser auch aus einiger distanz klar und leicht erkennbar sein müssen. dabei ist das pixquick system jederzeit flexibel: auf papier gedruckte information wird einfach ausgetauscht.

EN matching with the pixquick signage series the new size for walls: frameless and dust-proof for a perfect information presentation. the information is printed on paper and can be easily exchanged anytime. thus you stay flexible with your signage. we recommend this system, especially for public buildings and big structures, where signs need to be clearly readable also from a certain distance.

A pixquick wall

1	PQ105600	pixquick 105x600mm, 1pc	size*
---	----------	-------------------------	-------

* altezza x larghezza | höhe x breite | height x width

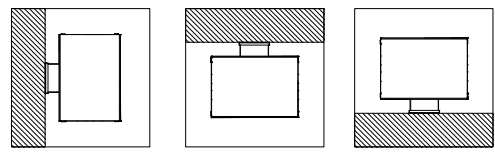

information

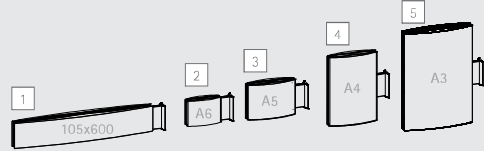

segnaletica a muro in metallo pressofuso, color argento, stampa ad iniezione in policarbonato trasparente

silber veredelter metall-druckguss wandhalter, polycarbonat spritzguss transparent

wall support made of silver plated metal die-cast, die-cast polycarbonate transparent

A pixquick flag

1	PQFG105600	pixquick flag 105x600mm, 1pc
2	PQFGA6	pixquick flag A6, 1pc
3	PQFGA5	pixquick flag A5, 1pc
4	PQFGA4	pixquick flag A4, 1pc
5	PQFGA3	pixquick flag A3, 1pc

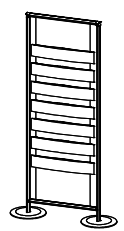

other possible combinations!

information

stampa ad iniezione in policarbonato trasparente, materiale per montaggio incluso

transparenter polycarbonat spritzguss, inkl. montagematerial

transparent die-cast polycarbonate, mounting material incl.





pixquick® suspension

MADE IN EU design by KD



IT il vostro sistema di segnaletica di direzione pixquick viene oggi arricchito di un nuovo fondamentale componente: pixquick ceiling, indicatore bifacciale a soffitto. il policarbonato trasparente realizzato tramite stampa ad iniezione e privo di cornici laterali garantirà alle vostre informazioni stampate su carta una protezione antipolvere. le informazioni potranno essere sostituite in qualsiasi momento senza l'utilizzo di utensili. il fissaggio a soffietto regge una portata di max. 5 targhe.

DE ihre wegweitsysteme mit pixquick signage werden durch die doppelseitigen, deckenabgehängten pixquick suspension perfekt ergänzt. transparenter polycarbonat-spritzguss präsentiert die auf papier gedruckte info rahmenlos und staubgeschützt. der austausch der info ist jederzeit ohne werkzeug ganz einfach möglich. die deckenbefestigung ist für maximal fünf schilder ausgelegt.

EN the pixquick ceiling perfectly completes your guideline system with pixquick signage. the transparent polycarbonate die-cast displays your paper print framelessly and dust-proof. the exchange is easily without tools at anytime. the ceiling support is designed for a maximum of five signs in total.

1 + 2
pixquick suspension + pixquick module

information

stampa ad iniezione in policarbonato trasparente, materiale di fissaggio a soffitto in policarbonato, cavi in acciaio 2x1m

transparenter polycarbonat spritzguss, deckenbefestigung kunststoff, stahlsieil 2x1m

transparent die-cast polycarbonate, synthetic ceiling support, steel wire 2x1m

stampa ad iniezione in policarbonato trasparente, sistema di congiunzione tra le targhe in materiale sintetico

transparenter polycarbonat spritzguss, kunststoff-verbinder für erweiterungsmodule

transparent die-cast polycarbonate, synthetic sign connector for modular system

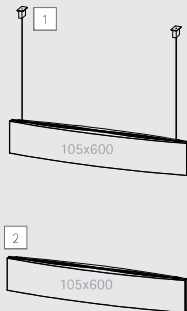

A pixquick suspension

1	PQXS105600	pixquick suspension incl. wire, 1pc
2	PQXSM105600	pixquick module for suspension, 1pc



pixquick® floor

MADE IN EU design by KD

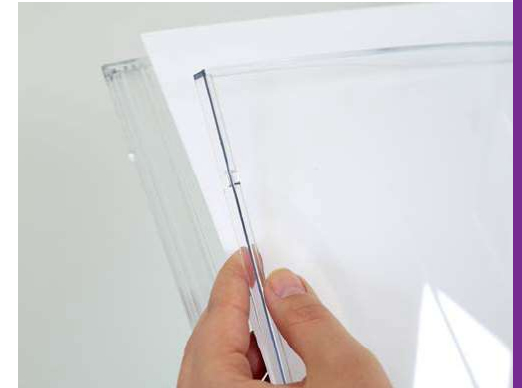

IT dalla nostra linea pixquick nasce pixquick floor, un display per informazioni da terra autoportante disponibile nei formati A4 e A3. l'espositore senza cornice può essere aperto da entrambi i lati ed è a prova di polvere. il cambio dell'informazione è quindi facile e veloce. una base stabile e il profilo in alluminio anodizzato color argento rendono questo display semplicemente perfetto.

DE aus unserer pixquick signage serie das freistehende bodendisplay für die informationspräsentation in A4 oder A3, der infohalter kann links oder rechts geöffnet werden. ihre info ist staubgeschützt und wird rahmenlos gezeigt. der austausch ist jederzeit ganz einfach möglich. ein stabiler standfuss und das silber eloxierte alu-profil runden dieses display ab.

EN from our pixquick signage series we present to you now the freestanding floor display for information in A4 or A3, the information support can be opened on both sides and it is dust-proof and frameless. content exchange is quick and easy, a stable base and the silver anodized aluminium profile makes this a perfect display.

information

tasche porta informazioni in policarbonato trasparente realizzate tramite stampa ad iniezione, alluminio anodizzato color argento, base in materiale sintetico verniciato in argento con di sostegno in metallo

infotafel transparenter polycarbonat spritzguss, silber eloxiertes aluminium, silber lackierter kunststoff-fuss mit gewichtplatte aus metall

transparent die-cast polycarbonate poster pocket, silver anodized aluminium

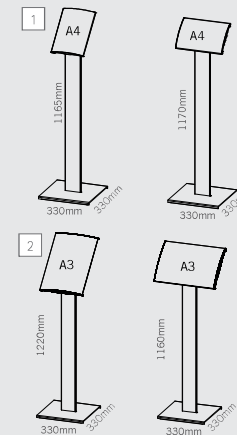

il pixquick può essere posizionato in orizzontale o verticale a seconda della necessità.

drehen sie einfach von horizontal auf vertikal oder umgekehrt, ganz nach bedarf!

simply turn from horizontal to vertical or vice versa, just as required!

A pixquick floor

1	PQFRA4	pixquick floor A4, 1pc
2	PQFRA3	pixquick floor A3, 1pc



infoglass & steel15



IT elegante sistema a sandwich in vetro e acciaio inox. il raffinato set per segnaletica di informazione e direzione. due lastre di infoglass nei 5 formati più comuni, complete rispettivamente di 2 o 4 distanziali steel 15 con anellini di protezione e materiale per il montaggio. fissaggio su vetro? nessun problema grazie a fisso rosett. fissaggio: sistema di fissaggio con chiusura di sicurezza, a prova di manomissioni. materiale: acciaio inox AISI304, testina sfaccettata, vetro di sicurezza temperato, 4 mm, angoli sfaccettati a 45°. distanza dalla parete: 15mm.

DE edles edelstahl-glas-sandwichsystem. das hochwertige set für information, orientierung und beschil-derung. zwei infogläser in fünf gängigen grössen komplett mit zwei bzw. vier steel15 haltern, glasschutzringen und montage-material. befestigung auf glas? mit fisso rosett kein problem. befestigung: stecksystem mit arretierung, manipulationsicher. material: halter: edelstahl AISI304, facettenschliff. glas:temperiertes sicherheitsglas, 4mm, kanten mit 45°-facetten-schliff. wandabstand: 15mm.

EN noble sandwich-system in stainless steel and glass. the high-class set for information, orientation and signage. two infoglass in five common sizes completely with two resp. four steel15 spacers, glass protecting rings, screws and dowels. fastening on glass? no problem with fisso rosett. mounting: plug-interlocksystem, tamper-proof. material: spacer: stainless steel AISI304, faceted surface. glass: tempered glass, 4mm, edges grinded 45°. wall distance: 15mm.

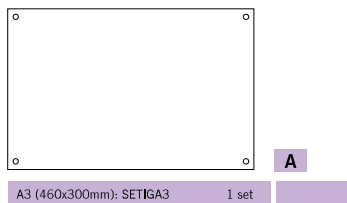
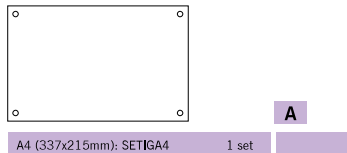
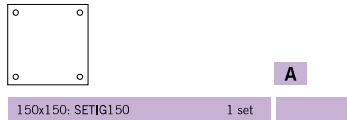
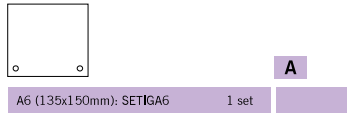

information



set infoquick & midi



IT set completo a tasca per un cambio di informazioni facile e veloce. cambiare informazioni in ogni momento, senza utensili e velocemente? nessun problema grazie alla tasca infoquick. il set si compone di una tasca in plex nei 4 formati più comuni e di 2 o 4 distanziali midi in argento satinato o cromo lucido e di materiale per il montaggio. fissaggio: sistema di fissaggio con chiusura laterale di sicurezza, a prova di manomissioni. materiale: distanziale in ottone con cromatura della superficie in color argento o cromo; pannello in acrilico trasparente piegato a tasca. distanza dalla parete: 21mm.

DE kompletset mit einschub: infowechsel schnell und bequem. info-austausch jederzeit ohne werkzeug, schnell und unkompliziert? mit der einschubtasche von infoquick kein problem. das infoset erhalten Sie in vier grössen komplett mit 2 oder 4 haltern fisso midi in silber oder chrom und montage-material. befestigung: stecksystem mit arretierung, manipulationsicher. material: halter: messing oberflächenveredelt in silber und chrom. infoquick: acrylglas transparent, gebogen mit einschub. wandabstand: 21mm.

EN infoset with slide-in pocket: exchange quick and easy. no information exchange anytime without any tools, fast and easy? that's no problem with the slide-in pocket of infoquick. the infoset comes in four sizes, completely with 2 or 4 fisso midi spacers, silver or chrome including screws and dowels. mounting: plug-interlocksystem, tamper-proof. material: spacers: brass, silver- or chrome-plated, wall distance: 21mm.

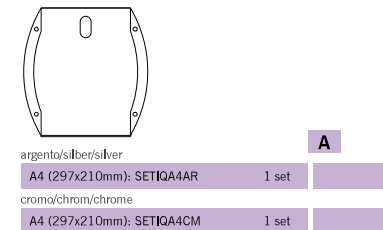
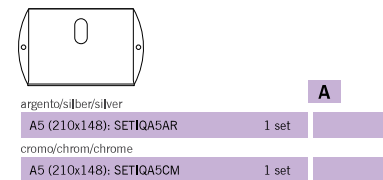
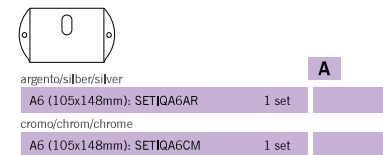
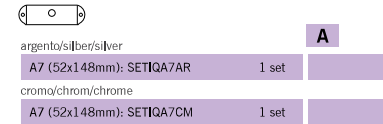

information





3 + 11
price for this combination



information

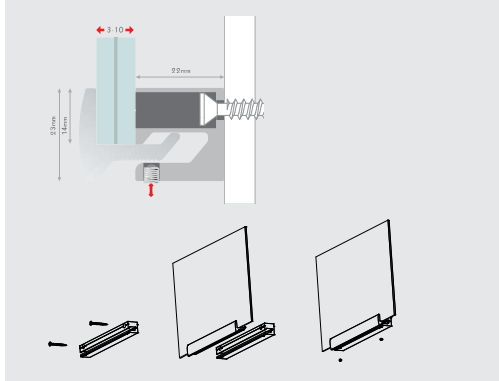

clamper

MADE IN EU design by KD

IT elegante sistema ad incastro per pannelli privi di fori, pannelli di spessore diverso potranno essere assicurati senza bisogno di fori. clamper può essere usato in diverse lunghezze, mono o bifacciale, per sistemi a sandwich o per singoli pannelli, abbiamo selezionato per voi pannelli di vetro temperato nei formati più comuni.

DE elegantes Klemmsystem für paneele ohne bohrung, paneele diverser stärken werden ohne bohrung sicher befestigt. clamper kann ein- oder zweiseitig, im sandwichsystem oder mit einzelpaneelen verwenden, temperierte gläser gängiger grössen haben wir für sie zusammengestellt.

EN elegant clamp system for panels without holes, panels of different thicknesses are safely fastened without holes, you can use clamper in different lengths, on one or two sides, as sandwich system or with single panels. we provide you also with tempered glass panels in the most common sizes.



A	clamper	description hxb
1	FCL60	clamper 60mm,1pc
2	FCL100	clamper 100mm,1pc
3	FCL200	clamper 200mm,1pc
4	FCL300	clamper 300mm,1pc
5	FCL400	clamper 400mm,1pc
6	FCL600	clamper 600mm,1pc
7	FCL900	clamper 900mm,1pc
8	FCL2000*	clamper 2000mm,1pc
9	FCL150150VE	glass 150x150x4mm,1pc
10	FCL150300VE	glass 150x300x4mm,1pc
11	FCL300450VE	glass 300x450x4mm,1pc
12	FCL450600VE	glass 450x600x4mm,1pc

* fino ad esaurimento scorte | solange vorrat reicht | while stock last

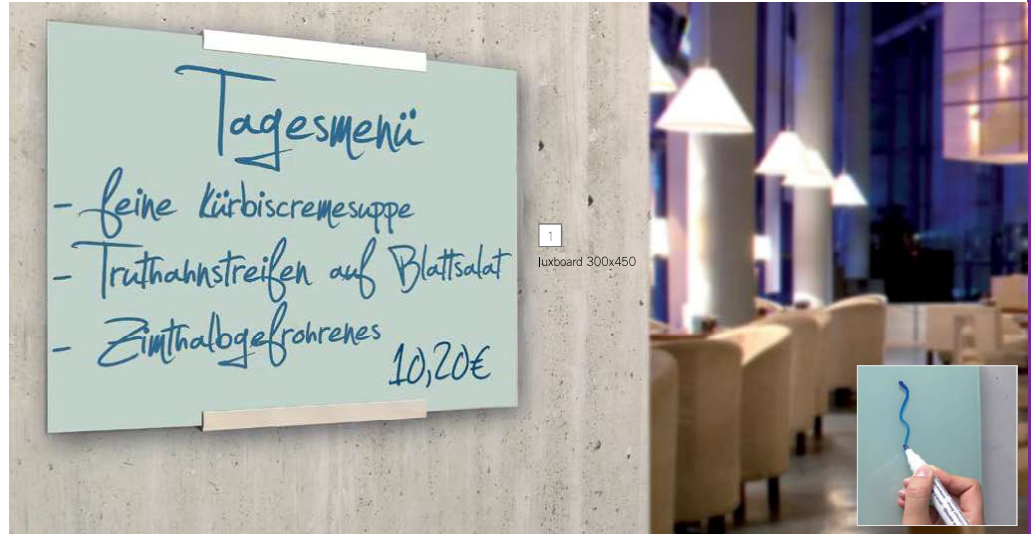

1
luxboard 300x450

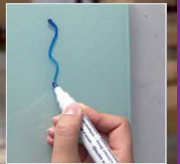

information

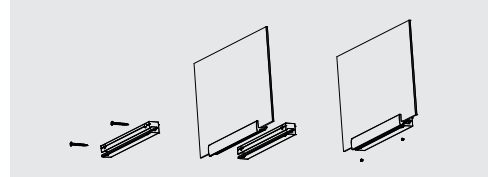

luxboard

MADE IN EU design by KD

IT nobile: lavagna in vetro, pannello di vetro temperato 6mm di spessore, retro serigrafato in bianco, fissaggio a fisso clamper in alluminio anodizzato color argento, potete attaccare i vostri messaggi su luxboard oppure scrivere direttamente sulla lavagna con pennarelli cancellabili a secco, un vero e proprio articolo di design per un'atmosfera ricercata in una lobby, in un club, in negozio, in ufficio o anche a casa.

DE edel: wandtafel aus glas, temperiertes 6mm starkes glas-paneel, rückseitig weisser siebdruck, befestigung mit fisso clamper aus silber eloxiertem aluminium, luxboard kann beklebt oder mit trocken abwischbaren stiften beschriftet werden, ein echtes designstück für cooles ambiente in lobby, bar, lounge, club, shop-, office- oder homebereich.

EN noble: whiteboard in glass, tempered 6mm strong glass panel, rear side with white silkscreen print, mounting with fisso clamper made of silver anodized aluminium, on luxboard you can paste your messages or write them with non permanent whiteboard markers, a real designer's item for cool ambience in the lobby, bar, lounge, club, shop, office or at home.

A	luxboard	description hxb
1	LXB300450*	luxboard 300x450mm, 1pc
2	LXB600450*	luxboard 450x600mm, 1pc
3	LXB900600*	luxboard 600x900mm, 1pc

* fino ad esaurimento scorte | solange vorrat reicht | while stock last



3
clipper 700x500mm



information

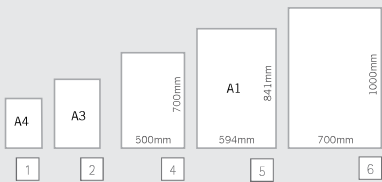

clipper

MADE IN EU design by KD



IT cornici velocemente intercambiabili per sistemi a parete, su cavo o su astine. per poster, manifesti, immagini, foto o per qualsiasi altro tipo di informazione. alluminio anodizzato, robusto retro in materiale plastico, foglio protettivo trasparente resistente ai raggi uv e antiriflesso. dotate di fori, per montaggio a parete, anche idoneo per il fissaggio su cavi di acciaio o astine, basta forare la cornice lateralmente. semplice ed efficace. disponibili nei formati più comuni.

DE schnellwechsel-rahmen für wand, seilspann- und stangensysteme. für poster, werbeplakate, bilder, fotos oder andere infos. silbereloxiertes aluminium, stabile kunststoffrückwand, plakatabdeckung aus uv-beständiger und reflektionsmindernder schutzfolie. mit lochbohrungen für einfache wandmontage. auch für befestigung auf stahlsel oder stangensystem geeignet, einfach entsprechende lochbohrungen seitlich selbst anbringen. in allen gängigen formaten.

EN quick exchange frame for wall, suspension systems on cable or bars. for posters, pictures, fotos, prints, ads or other information. silver anodized aluminium frame, stable synthetic back, front protection made of uv-resistant and non-reflecting lamination sheet. with holes for easy mounting on walls. can also be mounted with cables or bars, just make the needed holes at the frames side profiles. available in the most common sizes.

A clipper

	description	hxb
1	YCLA4	clipper A4, 1 pc
2	YCLA3	clipper A3, 1 pc
3	YCL700500	clipper 700x500mm, 1 pc
4	YCLA1	clipper A1, 1 pc
5	YCL1000700	clipper 700x1000mm, 1 pc

clippinfo

MADE IN EU design by KD



1
clippinfo 700x500mm



IT le cornici a scatto clipper si incontrano con il nostro profilo multifunzionale soistes. il profilo in alluminio anodizzato color argento poggia sulla robusta base con rivestimento di protezione in abs e sostiene stabilmente la cornice di alluminio anodizzato color argento, dotata di retro in materiale sintetico e frontale protettivo trasparente resistente ai raggi UV e antiriflesso.

DE schnellwechselrahmen clipper meets multitalent soistes: silbereloxiertes aluminiumprofil auf rundbasis mit abs-trittschutz ring gibt sicheren stand für die clipper-rahmen aus silbereloxiertem aluminium, mit stabiler kunststoffrückwand und plakatabdeckung aus uv-beständiger und reflektionsmindernder schutzfolie.

EN quickly interchangeable frame clipper meets all-rounder soistes: silver anodised aluminium extrusion on a base with abs protection gives a stable stand to the silver anodised aluminium frame, with a plastic rear and a transparent poster cover sheet, uv-resistant and reflection proof.

information

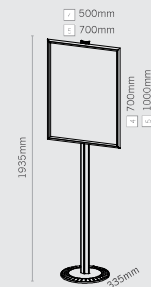

A clippinfo

	description	hxb
1	SOCI700500	clippinfo 700x500mm, 1 pc
2	SOCI1000700	clippinfo 1000x700mm, 1 pc



2
lumo clipper A3



information

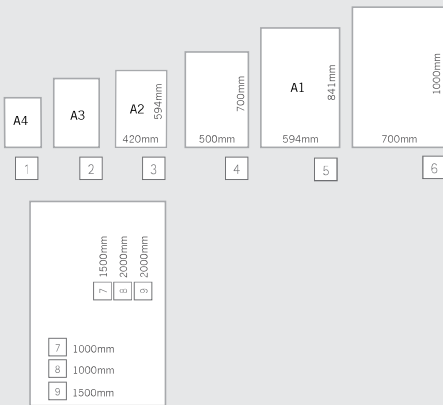

lumo clipper

MADE IN EU controlled by KD

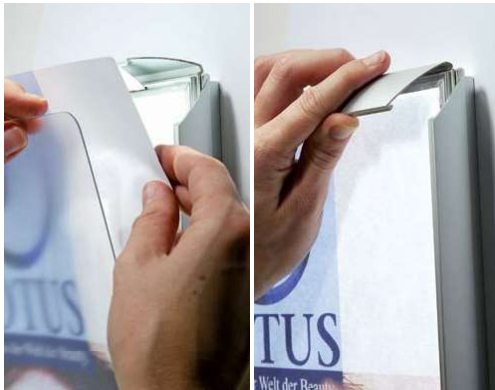

IT il nostro lumo clipper è composto da una cornice a scatto completa di retroilluminazione a led, il foglio protettivo, in materiale sintetico trasparente a bassa riflessione, è resistente ai raggi UV, la cornice a scatto realizzata in alluminio anodizzato è una soluzione elegante, che mette in risalto la linea moderna del prodotto, questo sistema facilita la sostituzione di informazioni in modo veloce e semplice.

DE unser lumo clipper ist ein klapprahmensystem mit hinterleuchtung durch LED, die abdeckfolie ist aus uv-beständigem und reflektionsarmen transparentem kunststoff, der klapprahmen in elegantem silbereloxiertem aluminium unterstreicht den modernen look, ihre info können sie schnell und einfach jederzeit wechseln.

EN our lumo clipper is a clip frame system with back lighting by LED, the transparent cover is uv-resistant and non reflective, the clip frame made of silver anodized aluminium emphasizes the elegant look, your information is changed quickly and easily at anytime.

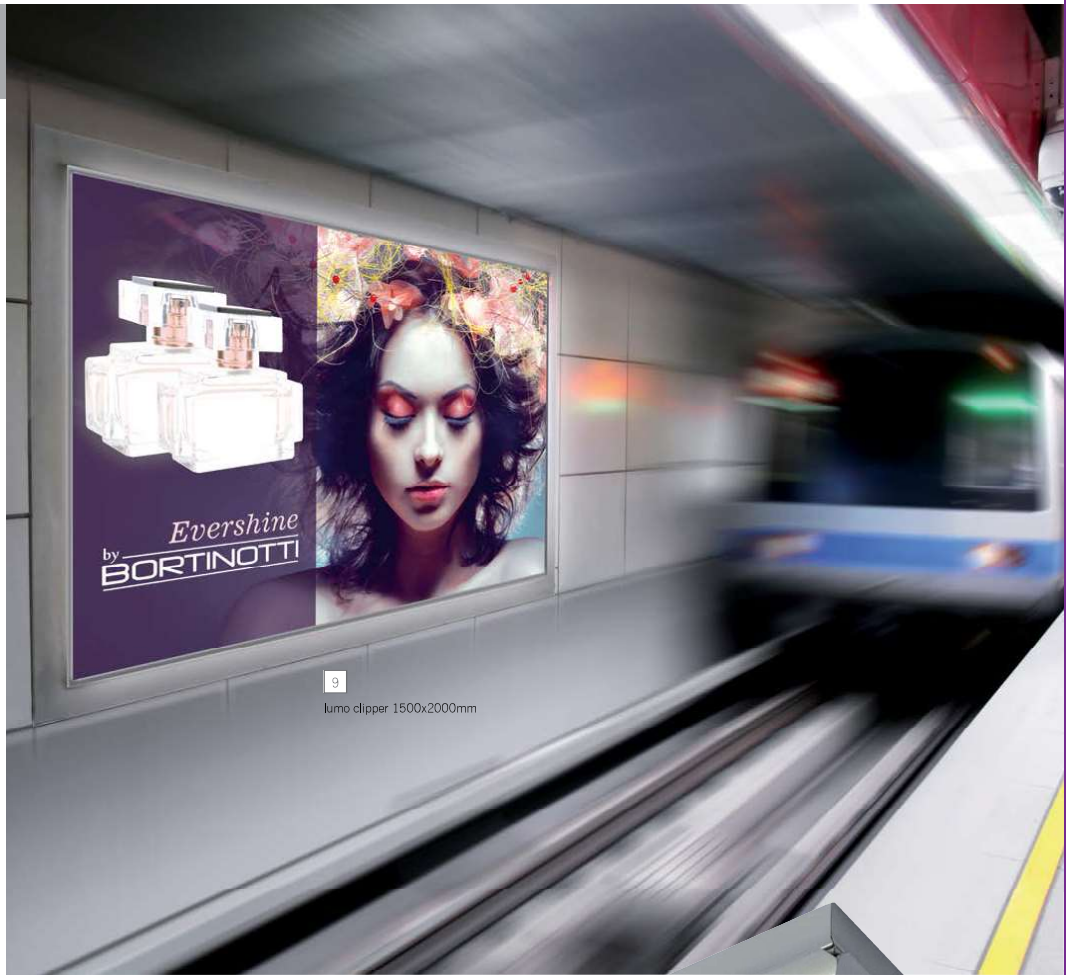

9
lumo clipper 1500x2000mm



cornice a scatto con retroilluminazione a led

klapprahmensystem mit led hinterleuchtung

clip frame system with led back lighting

B lumo clipper

description hxb



	description hxb	
1	LCLA4 lumo clipper A4, 1pc	
2	LCLA3 lumo clipper A3, 1pc	
3	LCLA2 lumo clipper A2, 1pc	
4	LCL700500 lumo clipper 700x500mm, 1pc	
5	LCLA1 lumo clipper A1, 1pc	
6	LCL7001000 lumo clipper 700x1000mm, 1pc	
7	LCL10001500 lumo clipper 1000x1500mm, 1pc	
8	LCL10002000 lumo clipper 1000x2000mm, 1pc	
9	LCL15002000 lumo clipper 1500x2000mm, 1pc	

presentazione eccellente con luci led di qualità

brillante präsentation mit hochwertigen led-leuchten

brilliant presentation with first choice led-lights



led-lights



information

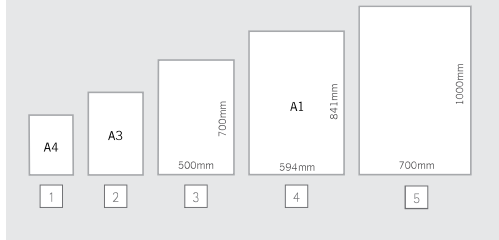

lumo

MADE IN EU design by KD

IT Lumo è il pannello illuminato da parete di prima classe. il pannello in acrilico di 8 mm al contrario dei pannelli serigrafati è inciso e questo garantisce una regolare ed uniforme illuminazione anche nei formati più grandi. i led che utilizziamo per Lumo sono di alta qualità e garantiscono una lunga durata d'impiego. il foglio protettivo flessibile in policarbonato è resistente ai raggi uv e grazie al sistema di chiusura magnetica può essere sollevato in parte o completamente, rendendo così il cambio del manifesto rapido e semplice. il bordo laterale di 30mm serigrafato di colore nero è discreto e nel contempo elegante.

DE Lumo für die wandmontage ist ein extra flaches leuchtpanel der sonderklasse. das 8mm starke acryl ist graviert und somit garantiert es im gegensatz zum siebdruck die gleichmässige und vollständige ausleuchtung der gesamten fläche. die hochwertigen LED haben eine sehr lange lebensdauer. die transparente und flexible folie aus polycarbonat ist uv-beständig. durch den magnetverschluss ist sie teilweise oder auch komplett abnehmbar und der austausch der information ist damit jederzeit schnell und unkompliziert möglich. das schwarze siebdruck passepartout ist mit geringen 30mm sehr dezent gehalten.

EN lumo for wall mounting is a special flat high quality light panel. the 8mm thick acrylic is etched and guarantees, unlike screen printed glass, a perfect and uniform illumination of the whole panel. the high-grade LED have a very long lifetime. the transparent and flexible cover sheet in polycarbonate is uv-resistant. thanks to the magnetic closing, the cover sheet can be removed partly or even completely, making the exchange of the poster quick and easy anytime. the black serigraph edges are very discreet at only 30mm.



	B	lumo	description hxb	
1	LUMORA4	Lumo A4, 1pc		
2	LUMORA3	Lumo A3, 1pc		
3	LUMOR700500	lumo 700x500mm, 1pc		
4	LUMORA1	Lumo A1, 1pc		
5	LUMOR1000700	lumo 1000x700mm, 1pc		



cornice: alluminio anodizzato color argento, angoli in zamac color argento
 rahmen: silber eloxiertes aluminium, versilberte eckverbinder aus metalldruckguss
 frame: silver anodised aluminium profile, corner connectors made of zamac in silver

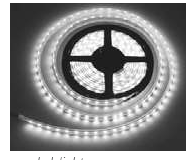
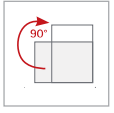

presentazione eccellente con luci led di qualità
 brillante präsentation mit hochwertigen led-leuchten
 brilliant presentation with first choice led-lights

led-lights



prints and banners not included

lumo twist

MADE IN EU design by KD



led-lights

presentazione eccellente con luci led di qualità

brillante präsentation mit hochwertigen led-leuchten

brilliant presentation with first choice led-lights

IT una soluzione elegante ed astuta, che combina un pannello luminoso con una stampa personalizzata su dibond o su banner in tessuto: gli elementi del pannello luminoso lumo sono ruotabili di 360° in passi di 22,5°, sono disponibili due misure per le cornici con due rispettivi moduli abbinabili, sul retro è possibile montare banner in tessuto o pannelli compositi. L'informazione nei pannelli luminosi lumo è facilmente sostituibile, grazie alla cornice frontale magnetica. lumo twist: per le vostre presentazioni di grande effetto.

DE eine elegante und pfiffige kombination aus leuchtpaneel und personalisierung mit druck auf dibond oder textilem banner: die elemente mit den leuchtpaneelen der lumo serie lassen sich um 360° drehen und rasten in 22,5° schritten ein. zur auswahl haben wir zwei grössen an rahmenstrukturen und je zwei module, die sie miteinander kombinieren können. auf der rückseite können sie entweder textile banner oder verbundpaneele montieren. die info in den lumo leuchtpaneelen wird dank des magnetisch befestigten passepartouts schnell gewechselt. der lumo twist: ein strahlender auftritt für ihre präsentation.

EN an elegant and smart combination of light panel and customization with print on dibond or textile banners: the structure with the light panels of the lumo series can be turned 360° and stop every 22,5°, for your choice we offer two sizes of frame structures and two elements that can be combined with each other, on the rear side of the structure you can mount either textile banners or composite panels. thanks to magnets the cover of the lumo light panels can be removed easily, allowing you to exchange the information quickly, the lumo twist: an illustrious appearance for your presentations.

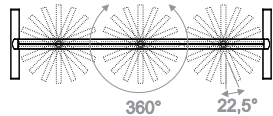

B lumo twist

description hxb

	description hxb	
1	SOCL2050720 lumo twist structure small, 1pc	
2	SOCL20501570 lumo twist structure big, 1pc	
3	SOCL3A4 lumo twist 3xA4, 1pc	
4	SOCL700500 lumo twist 700x500mm, 1pc	



2 +2x 3 +1x 4 lumo twist

prints and banners not included

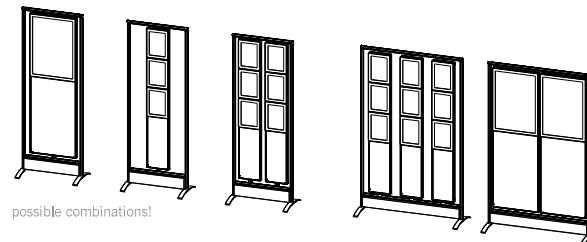

possible combinations!



la cornice frontale magnetica rende la sostituzione delle vostre informazioni nei moduli luminosi semplice e facile

magnethalterungen im passepartout machen den austausch ihrer info in den leuchtmodulen einfach und schnell!

magnetic supports in the cover foil make the exchange of your information in the light panels easy and quick



banners not included



i banner in tessuto possono essere applicati sul retro in modo semplice e veloce, senza l'utilizzo di utensili

textile banner können auf der rückseite einfach und schnell ohne werkzeug eingesetzt und ausgetauscht werden

fabric banners can be easily attached and exchanged at anytime without the need for tools

information

alluminio anodizzato color argento, connettori cromati color argento satinato. al momento dell'ordine si prega di indicare la posizione dei moduli per l'installazione dei cavi.

silber eloxiertes aluminium, silbermatt verchromte verbinder. bei bestellung position der module angeben für kabelverlegung

anodized aluminium, silver matt plated connectors. when ordering, indicate position of panels for correct cable settings

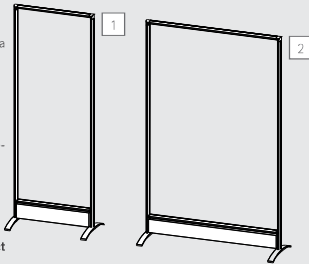

alluminio anodizzato color argento, connettori color argento satinato. al momento dell'ordine si prega di indicare la posizione dei moduli per l'installazione dei cavi.

lumo leuchtpaneel auf matt-schwarzem alu-verbund-paneeel, (rückseitig option für stoffbanner oder verbundpaneeel - nicht im lieferumfang enthalten)

lumo light panel on matt black aluminium-composite panel. (rear part option for textile banner or panel - not included)

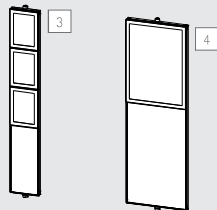



3
magnedoor A1



information



magnedoor®

MADE IN EU design by KD

IT cornici con chiusura magnetica, alluminio anodizzato, robusto retro in materiale plastico, bordi stampati di color grigio-argento, foglio protettivo in policarbonato flessibile, fissato al profilo con colla sul lato inferiore, un robusto listello magnetico rende possibile il fissaggio del foglio protettivo alla struttura, cambiare informazioni è quindi facile e veloce; adatto a montaggio orizzontale e verticale.

DE schnellwechselrahmen mit magnetverschluss, silber eloxierte aluminiumrahmenprofile, stabile kunststoffrückwand, plakatabdeckung aus flexibler polycarbonat-folie, am rand mit silbergrauem siebdruck, einseitig verklebt, eine starke magnetleiste hält die flexible folie sicher fest, info-wechsel schnell und einfach, für horizontale oder vertikale montage.

EN quick exchange frame with magnetic closing, silver anodized aluminium frame, stable synthetic back, front protection made of flexible polycarbonate foil, with silver grey silkscreen printed border, fixed with glue on one side, a strong magnetic strip holds the flexible foil firmly in place, information exchange is quick and easy, for mounting horizontally and vertically.

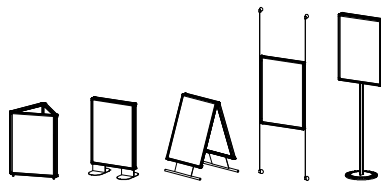
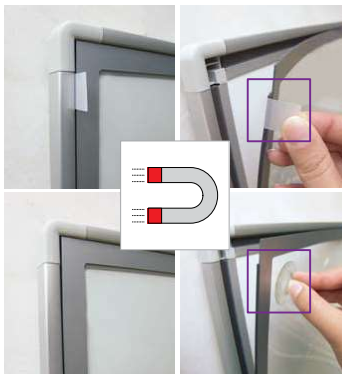

A magnedoor

	description	hxb
1	MADA4	magnedoor A4, 1pc
2	MADA3	magnedoor A3, 1pc
3	MADA1	magnedoor A1, 1pc
4	MAD700500	magnedoor 700x500mm, 1pc
5	MAD1000700	magnedoor 1000x700mm, 1pc
6	MAD14001000	magnedoor 1400x1000mm, 1pc

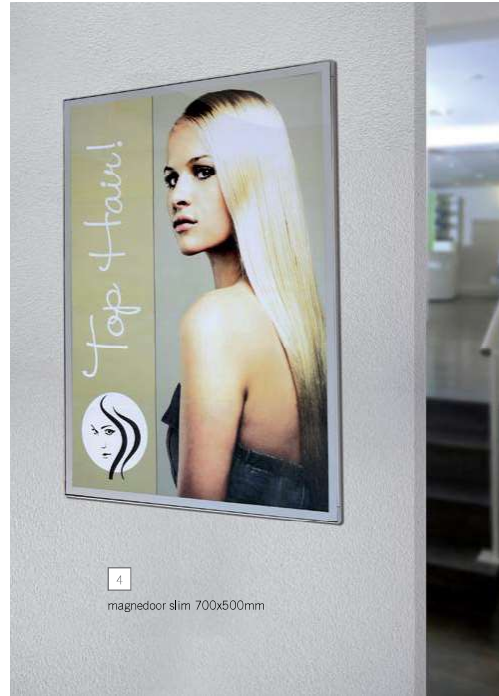

4
magnedoor slim 700x500mm



magnedoor® slim

MADE IN EU design by KD

IT cornici con chiusura magnetica, restyling per un aspetto più snello e leggero, alluminio anodizzato, robusto retro in materiale plastico, bordi stampati di color grigio-argento, foglio protettivo in pvc flessibile anti-riflesso completamente rimovibile, un robusto listello magnetico rende possibile il fissaggio del foglio protettivo alla struttura, cambiare informazioni è quindi facile e veloce, adatto a montaggio orizzontale e verticale.

DE schnellwechselrahmen mit magnetverschluss, restyle mit schlanker optik und weniger gewicht, silber eloxierte aluminiumrahmenprofile, stabile kunststoffrückwand, komplett abnehmbare plakatabdeckung aus flexibler nicht spiegelnder pvc-folie, am rand mit silbergrauem siebdruck, eine starke magnetleiste hält die flexible folie sicher fest, info-wechsel schnell und einfach, für horizontale und vertikale montage.

EN quick exchange frame with magnetic closing, restyled with a lean look and less weight, silver anodized aluminium frame, stable synthetic back, front protection made of flexible non reflective pvc foil, with silver grey silkscreen printed border, the flexible foil is completely removable and a strong magnetic strip holds it firmly in place, information exchange is quick and easy, for mounting horizontally and vertically.



cornice: alluminio anodizzato color argento, angoli in zamac color argento

rahmen: silber eloxiertes aluminium, versilberte eckverbinder aus metall-druckguss

frame: silver anodised aluminium profile, corner connectors made of zamac in silver



ulteriori informazioni pag. 322
mehr details s. 322
more information p. 322

A magnedoor slim

	description	hxb
1	MASA5	magnedoor slim A5, 1pc
2	MASA4	magnedoor slim A4, 1pc
3	MASA3	magnedoor slim A3, 1pc
4	MASA2	magnedoor slim A2, 1pc
5	MAS700500	magnedoor slim 700x500mm, 1pc
6	MASA1	magnedoor slim A1, 1pc
7	MAS1000700	magnedoor slim 1000x700mm, 1pc



magnofloor

MADE IN EU design by KD

IT magnofloor, una soluzione efficace per esporre poster informativi e cambiarli velocemente. posizioni il porta poster all'altezza desiderata e lo monti al profilo utilizzando le viti filettate. il cambio dell'informazione è semplice: il protettivo frontale è fissato con dei magneti ed è possibile aprirlo o rimuoverlo completamente, i portaposter vengono acquistati singolarmente: in questo modo, se lo si desidera, sarà possibile utilizzare magnofloor anche in modo bifacciale.

DE magnofloor zeigt ihre schnell zu wechselnde posterinfo, sie platzieren den posterhalter selbst in der gewünschten höhe und montieren dann mit den gewindeschneidenden schrauben am profil. die info kann einfach ausgetauscht werden: das frontcover ist magnetisch befestigt und lässt sich öffnen oder komplett abnehmen. zusätzlich bieten wir die posterhalter einzeln an, so können sie im bedarfsfall den magnofloor auch doppelseitig nutzen.

EN magnofloor displays your quick exchange poster information, you place the poster holder on the needed height and then fix it with the thread-cutting screws to the profile. the information can be easily exchanged anytime: the front protection cover is fixed magnetically and can be opened or completely removed, we provide you also with additional poster holders, in case you want to turn your magnofloor into a double side floor stand.



advantages

- ✔ portainformazioni autoportante da terra
freistehendes bodendisplay
- ✔ cambio veloce del banner informativo
infoposter schnell gewechselt
quick exchange of information poster
- ✔ flessibile grazie a chiusura magnetica
flexibel dank magnetabdeckung
flexible thanks to the magnetic cover
- ✔ design snello e moderno
schlankes, modernes design
lean and modern design
- ✔ utilizzo bifacciale possibile
auch doppelseitig erweiterbar
can be upgraded for double side use



poster display auf gewünschter höhe positionieren und mit den gewindeschneidenden schrauben befestigen

place poster display on the needed height and fix it with the thread cutting screws

estensione bifacciale: ordini le tasche aggiuntive nei formati che preferisci, esse verranno poi fissate alla scanalatura sul retro del profilo con le viti filettate all'altezza desiderata

doppelseitige erweiterung: einfach zusätzliche taschen in gewünschten format dazubestellen, die taschen werden dann mit den gewindeschneidenden schrauben auf der rückseitigen nut des profils in entsprechender höhe angebracht

double-side upgrade: simply order additional pockets in the needed format, the pockets are then mounted to the rear nut of the profile with the thread cutting screws.

information

profilo in alluminio anodizzato color argento, porta poster con copertura in grigio serigrafato, resistente ai raggi UV, antiriflesso e con chiusura magnetica
base in metallo con copertura in materiale plastico

silber eloxiertes alu-profil, posterhalter mit grau-besiedrucker, uv-beständiger, reflektionsarmer abdeckung mit magnetverschluss
metall basis mit kunststoff-abdeckung

silver anodized aluminium profile, poster pocket with grey screen printed, uv-resistant and reflection reduced cover with magnets
metal base with synthetic cover

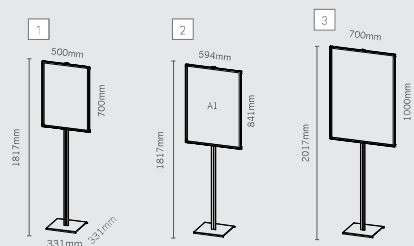
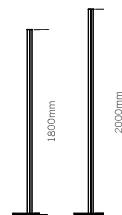

A	magnofloor	description hxb
1	MGF700500	magnofloor 700x500mm, 1pc
2	MGFA1	magnofloor A1, 1pc
3	MGF1000700	magnofloor 1000x700mm, 1pc
4	MGFMS700500	magnedoor slim 700x500mm, 1pc
5	MGFMSA1	magnedoor slim A1, 1pc
6	MGFMS1000700	magnedoor slim 1000x700mm, 1pc
7	MGFS1800	single profile 1800mm, 1pc
8	MGFS2000	single profile 2000mm, 1pc



other possible combinations on request

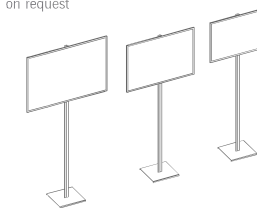



2 mago magnedoor 4x44v

mago magnedoor

MADE IN EU design by KD

IT con mago il sistema magnedoor si trasforma in una vera e propria bacheca da parete con foglio protettivo in policarbonato flessibile e chiusura magnetica per proteggere le vostre informazioni, tra le altre cose, contro l'acqua e l'umidità; mago è quindi anche adatto ad ambienti esterni protetti, il retro-pannello è magnetico e scrivibile.

DE das magnedoor system als schaukasten mago mit flexibler polycarbonat-fole und magnetverschluss schützt ihre info vor spritzwasser und feuchtigkeit und ist daher durchaus für geschützte aussenbereiche geeignet. die rückwand ist magnetisch und kann wie ein whiteboard mit abwischbaren stiften beschrieben werden.

EN the magnedoor system as a wall cabinet mago with a protective sheet in flexible polycarbonate and a magnetic closing system protects your information from drops of water and humidity, therefore it is also adapt for sheltered outdoor areas, the rear panel is magnetic and is writable like a whiteboard with non permanent markers.



cornice in alluminio anodizzato con protettivo in policarbonato flessibile e chiusura magnetica, retro-pannello magnetico e scrivibile.

silber eloxierter aluminium profilrahmen mit magnetverschluss, flexible polycarbonat-fole, rück-wand magnetisch und beschreibbar

silver anodised aluminium frame with magnetic lock, flexible polycarbonate cover, rear panel magnetic and writable

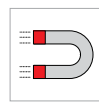

A mago magnedoor

description hxb

	description	hxb
1	MAGO2A4V	mago magnedoor 2x44v, outersize 542x392mm, 1pc
2	MAGO4A4V	mago magnedoor 4x44v outersize 542x742mm, 1pc
3	MAGO6A4V	mago magnedoor 6x44v outersize 742x742mm, 1pc



4 display cabinet 969x775mm

cartbox

MADE IN EU design by KD

IT cassetta espositiva e per deposito chiavi. alluminio anodizzato color argento, pannello in acciaio laminato bianco, piastra in plastica, chiusura a cilindro con 2 chiavi e materiale per il montaggio inclusi. lavagna scrivibile con pennarelli non indelebili, adatta per magneti, numerazione e ganci per 45 chiavi.

DE schau- und schlüsselkasten. silber eloxiertes aluminium, weissbeschichtete stahlwand, kunststoffscheibe, zylinderschloss mit 2 schlüsseln und montage-material inklusive, mit nicht permanenten whiteboard markern beschreibbar, für magneten geeignet. schlüsselkasten mit nummerierung und haken für 45 schlüssel.

EN display and key cabinet. silver anodised aluminium frame, white coated steel panel, plastic window, cylinder lock with 2 keys and mounting material inclusive. writeable panel for non permanent markers, suitable for magnets. key cabinet with numbering and hooks for up to 45 keys.



5 key cabinet



information

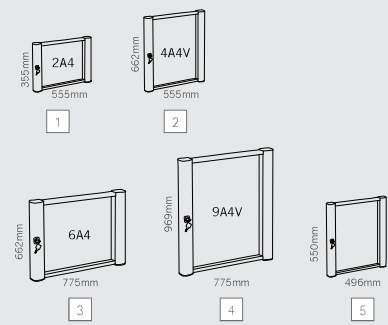

A cartbox

description hxb

	description	hxb
1	CB2A4	display cabinet outersize 355x555mm, 1pc
2	CB4A4V	display cabinet outersize 662x555mm, 1pc
3	CB6A4	display cabinet outersize 662x775mm, 1pc
4	CB9A4V	display cabinet outersize 969x775mm, 1pc
5	CB45	key cabinet, 45 keys, outersize 550x496mm, 1pc



maxilibro

MADE IN EU design by KD

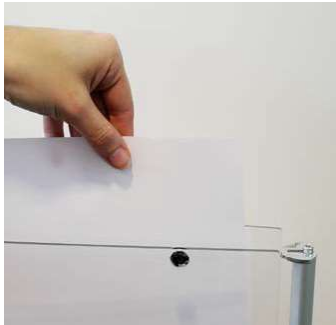

le tasche porta poster possono essere facilmente aperte dall'alto, permettendo così l'inserimento d'informazioni; chiusura magnetica

poster taschen oben öffnen, einfaches einlegen der info, mit magnetverschluss

poster pockets can be opened easily on top for information, magnetic lock

IT maxi poster tutti da sfogliare! maxilibro, l'espositore autoportante o con fissaggio a parete, le permette di esporre poster di grande formato: è possibile inserire fino a 6 tasche portaposter bifacciali in acrilico trasparente, potrà cambiare le informazioni rapidissimamente in ogni momento grazie alla chiusura magnetica delle tasche. maxilibro è dotato di due punti di rotazione, che mantengono quindi i poster perfettamente allineati e con la giusta angolazione. le tasche portaposter possono essere agganciate e sganciate dalla struttura in ogni momento e molto semplicemente senza l'ausilio di ulteriori utensili. maxilibro le permetterà di presentare sempre al meglio immagini, piantine e altre informazioni di grande formato: basterà solo sfogliarlo ammirando le sue pagine!

DE maxi poster zum blättern! mit maxilibro präsentieren sie poster im maxiformat auf hochwertige art freistehend oder wandbefestigt. bis zu sechs doppel-seitige postertaschen aus transparentem acryl können eingehängt werden, um darin zu blättern, die poster lassen sich durch den praktischen magnetverschluss jederzeit schnell wechseln. maxilibro verfügt über zwei drehpunkte, so liegen die poster immer im richtigen winkel zueinander. alle posterhalter können jederzeit ohne werkzeug einfach ein- und ausgehängt werden. mit dem maxilibro werden bilder, pläne und andere großformatige informationen bestens präsentiert: einfach blättern und staunen!

EN turn the pages with maxilibro! with maxilibro you display poster in bigger formats free standing or wall mounted in a classy way. up to six double side poster pockets in transparent acrylic can be attached. posters can be easily exchanged anytime thanks to the convenient magnet system. maxilibro has two pivots so that the posters always show themselves in the right way. all poster holders can be easily attached and exchanged without tools. maxilibro can display images, plans and other large format information at its best. simply turn the pages and be filled with wonder!

A maxilibro

	description	hxb
1	MLS1050140	maxilibro 1000x700mm wall support, 1pc
2	MLS750140	maxilibro 700x500mm wall support, 1pc
3	MLB1000700	maxilibro 1000x700mm poster pocket, 1pc
4	MLB700500	maxilibro 700x500mm poster pocket, 1pc
5	MLF1000700	maxilibro 1000x700mm floor, 1pc

2 + 6x 4

maxilibro



espositore autoportante da terra

freistehendes bodendisplay

free standing floor display

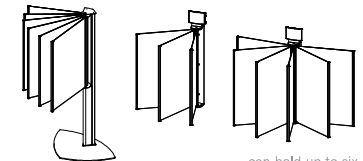

can hold up to six double-sided poster pockets

information

supporto a parete con tasca A5, alluminio anodizzato color argento

wandhalter mit A5 tasche, silber eloxiertes aluminium

wall support with A5 display, silver anodized aluminium

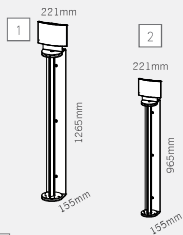

supporto per poster in acrilico trasparente, cornice in alluminio anodizzato color argento

posterhalter transparentes acryl, rahmen silber eloxiertes aluminium

poster support transparent acrylic, frame made of silver anodized aluminium

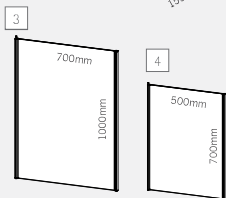

struttura autoportante in metallo laccato color argento satinato

freistehende struktur aus silbermatt lackiertem metall

freestanding floor display made of silver matt coated metal

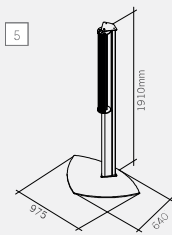

due punti di rotazione: quando l'espositore è chiuso, tutti i poster rimangono adiacenti alla parete

2 drehpunkte: geschlossen liegen alle poster bündig auf kante an der wand

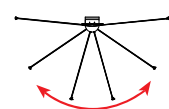

2 pivot points: closed all the posters align perfectly end-to-end

advantages

- visibile: le tasche sembrano pagine di un grande libro
anschaulich: blättern wie in einem buch
clear presentation: turn pages as in a book
- adatto per la presentazione di poster di grande formato
großformatige poster hochwertig präsentieren
display large format posters in a classy way
- rapido cambio dei poster grazie alla chiusura magnetica delle tasche
schneller posteraustausch dank magnetverschluss
quick exchange of poster thanks to magnetic system
- pratico montaggio delle tasche portaposter: aggancio e sgancio senza l'ausilio di utensili
praktische postertaschen montage: ein- und aushängen ohne werkzeug
convenient mounting of poster pockets: simply attachable without tools



double sided

maxilibro suspension

MADE IN EU design by KD





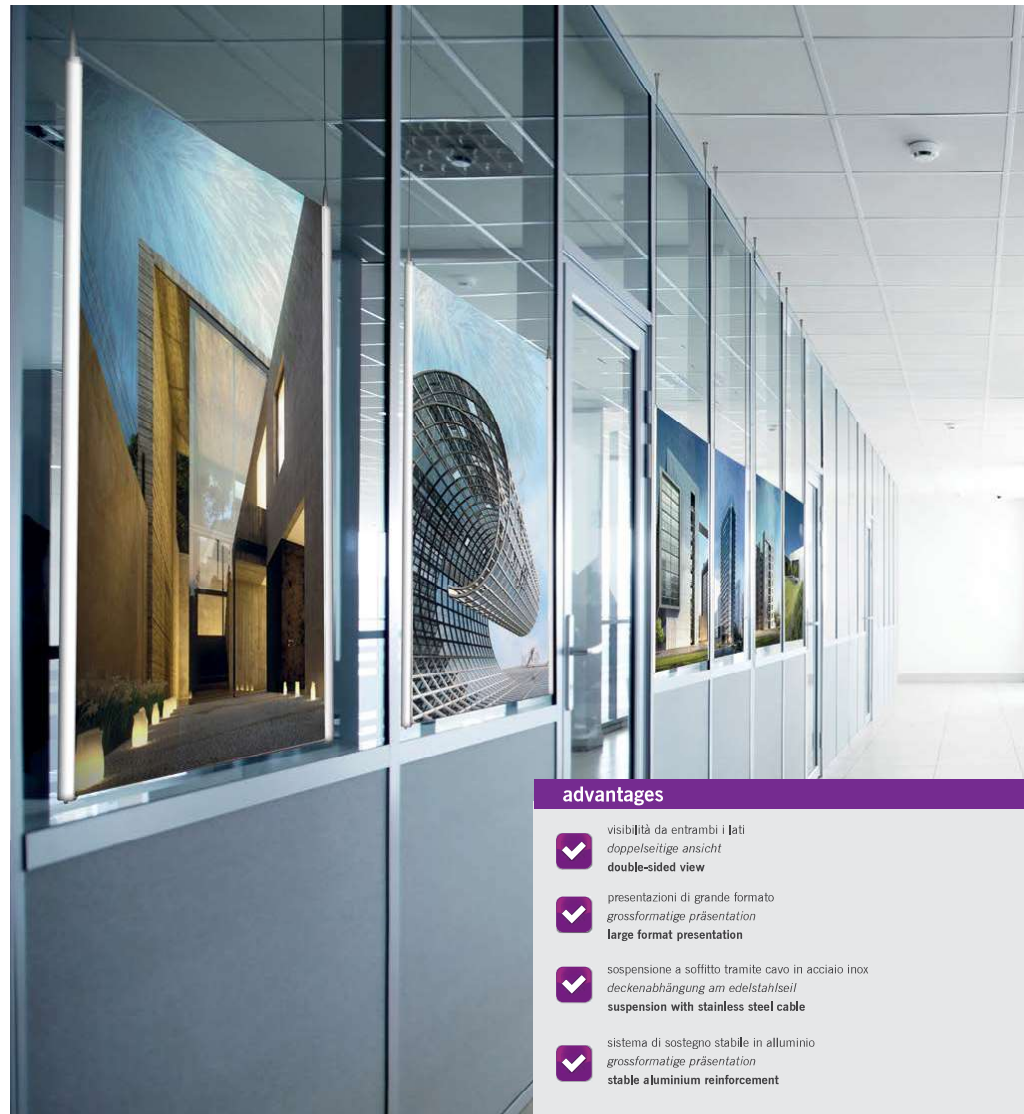

IT l'espositore a soffitto maxilibro suspension è adatto per ogni tipo di vetrina, grandi sale e lunghi corridoi. nelle tasche portainformazioni in acrilico trasparente possono essere inserite stampe di grande formato su entrambi i lati. la chiusura magnetica garantisce un cambio di informazioni veloce e semplice. il profilo laterale in alluminio anodizzato color argento dona al portaposter sospeso la stabilità necessaria. maxilibro suspension viene montato a soffitto tramite i nostri tiranti fly loop in ottone cromato e cavo di acciaio inox. il cavo può essere tagliato a seconda delle proprie esigenze

DE das deckenabhängige präsentationssystem maxilibro suspension ist perfekt für schauenster, große räume oder lange flure. die gebogenen postertaschen aus transparentem acryl werden mit grossformatigen drucken für die doppelseitige ansicht bestückt. der magnetverschluss garantiert einen schnellen und einfachen informationsaustausch. das seitlich fixierte silbermatt eloxierte aluminiumprofil sorgt für die nötige stabilität. befestigt wird maxilibro suspension mit unseren deckenhaltern für spannsel fly loop in silbermatt veredeltem messing und edelstahlseil. das seil längen sie selbst in der gewünschten grösse ab.

EN the poster holder for ceiling maxilibro suspension suits perfect for shop windows, big rooms or long hall-ways. In the bended poster pockets made of transparent acrylic you can easily insert big prints for a double-sided view. the magnetic closure guarantees a simple and quick exchange of information. the lateral profiles are made of silver anodized aluminium and gives the structure the needed stability. maxilibro suspension is mounted through our ceiling holder fly loop in plated brass and stainless steel cable. the cable can be cut individually.



advantages

- 
 visibilità da entrambi i lati
doppelseitige ansicht
double-sided view
- 
 presentazioni di grande formato
grossformatige präsentation
large format presentation
- 
 sospensione a soffitto tramite cavo in acciaio inox
deckenabhängung am edelstahlseil
suspension with stainless steel cable
- 
 sistema di sostegno stabile in alluminio
grossformatige präsentation
stable aluminium reinforcement

information

tasca portaposter in acrilico trasparente con profili in alluminio anodizzato color argento, 2 tiranti a soffitto per cavo fly loop in ottone cromato, 5m di cavo di acciaio inox.

postertasche aus transparentem acrylglas mit silbermatt eloxierten aluminiumprofilen, 2st deckenhalter fly loop messing silbermatt, 5m edelstahlseil.

poster pocket of transparent acrylic with silver anodized aluminium aluminium profiles, 2 pieces of ceiling holders fly loop brass satin silver, 5m stainless steel cable

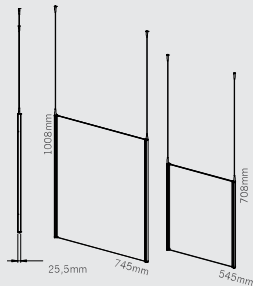

A maxilibro suspension

1	MLBS700500	maxilibro suspension 700x500mm, 1pc
2	MLBS1000700	maxilibro suspension 1000x700mm, 1pc

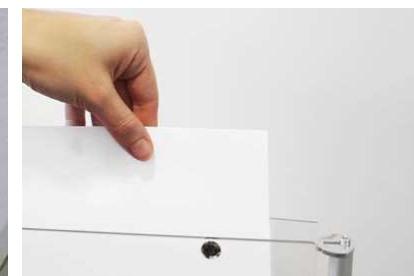



print not included

3 + 7

framframe 2000x1000mm + framframe base

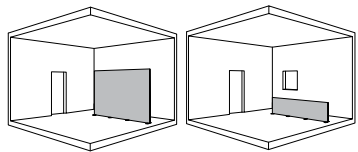

information

profili in alluminio anodizzato color argento, angoli in metallo pressofuso color argento opaco.

silber eloxierte aluminiumprofile, silbermatt veredelte metall-druckguss-eckverbinder

silver anodized aluminium profiles, silver matt plated zamac edge connectors

1-6



framframe floor

MADE IN EU design by KD

IT framframe floor può essere utilizzato con banner in tessuto mono- o bifacciali per creare espositori da terra autoportanti. i banner in tessuto sono sostituibili in modo veloce e in qualsiasi momento senza bisogno di smontare la struttura e ricorrere ad utensili. funge da parete divisoria, elemento decorativo o spazio pubblicitario. frontalmente sono visibili solo 2mm della cornice: i motivi rappresentati danno quindi l'idea di essere sospesi – la cornice passa in secondo piano.

DE framframe floor können sie ein- oder beidseitig mit textilen bannern für dekorative freistehende bodendisplays verwenden. die bedruckten stoffbanner können sie jederzeit schnell, ohne demontage und ohne werkzeug austauschen. ideal als raumteiler, dekoratives element oder werbefläche. frontal gesehen sind nur noch 2mm rand von der struktur sichtbar: die motive wirken autonom - das system hält sich diskret im hintergrund.

EN framframe floor you can use single- or double side with fabric banner for decorative freestanding floor displays. the printed banners can be exchanged quickly anytime without any tools. perfect as a partition, decorative element or advertising space. from the head-on view you see only 2mm of the structure: the images act for themselves - the framframe system steps back discreetly.



floor base

base di appoggio in metallo verniciato color argento
bodenplatte aus silberlackiertem metall
floor plate made of silver varnished metal



ulteriori informazioni pag. 158
mehr details s. 158
more information p. 158

158

B framframe floor

	size*	
1	FFR1500500	framframe 1500x500mm, 1pc
2	FFR2000800	framframe 2000x800mm, 1pc
3	FFR20001000	framframe 2000x1000mm, 1pc
4	FFR25001500	framframe 2500x1500mm, 1pc
5	FFR25002500	framframe 2500x2500mm, 1pc
6	FFRB300100	framframe base, 2pcs

* altezza x larghezza | höhe x breite | height x width

digipressto

MADE IN EU design by KD



panel not included

3 digipressto silver 400mm



1-4

profilo in alluminio anodizzato con protezione anti-scivolo, vite a testa zigrinata

klemmprofil aus eloxiertem aluminium, mit anti-rutsch schutz und rändelschraube

clamping profile made of anodized aluminium with anti-slip protection and knurled head screw



5

tappi laterali abs nero, set con 4 pz
seitenabdeckkappen abs schwarz, set mit 4 stück

lateral cover caps abs black, set with 4 pcs

ulteriori informazioni pag. 220
mehr details s. 220
more information p. 220

220

A digipressto

1	PT235	digipressto silver 235mm, 1pc
2	PT300	digipressto silver 300mm, 1pc
3	PT400	digipressto silver 400mm, 1pc
4	PT500	digipressto silver 500mm, 1pc
5	PTAKSZ	cover caps black, 4 pcs

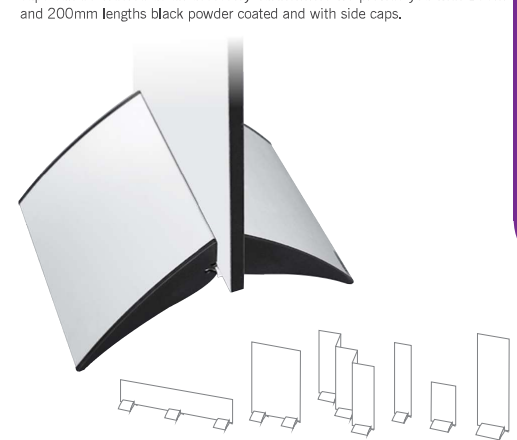

sign



print not included

pylo 1905x800mm

pylo

MADE IN EU design by KD

IT totem pylo: base metallica verniciata a polvere color argento e profili in alluminio anodizzato argento; i pannelli portainformazioni offrono una comoda e versatile superficie per stampe dirette, scrivibili o a plotter; il pylo è disponibile in tre differenti larghezze, ideale come sistema autoportante oppure abbinato agli elementi modulari del sistema soistes. i fori nella base permettono, se necessario, un sicuro ancoraggio al suolo.

DE totem pylo: silber pulverlackbeschichtete metallbasis, silber eloxierte aluminium-profile und -paneele zum bedrucken, bekleben und beschriften. erhältlich in drei verschiedenen breiten, optimal als freistehendes display oder in kombination mit dem modularen einrichtungssystem soistes. mit den lochbohrungen in der basis kann pylo bei bedarf sicher im boden verankert werden.

EN totem pylo: silver powder coated metal base, silver anodized aluminium extrusions and panels for print or laminate. available in three different widths. perfect as a freestanding display as well as in combination with our modular display system soistes. thanks to the holes in the base the pylo can be safely anchored in the ground if necessary.

ulteriori informazioni pag. mehr details s. more information p.

224

pylo



print not included

pylo 1900x600mm

pylo outdoor

MADE IN EU design by KD

IT pylo outdoor è concepito e realizzato appositamente per l'esterno: a seconda della collocazione, la struttura può essere interrata, ancorata o cementata al suolo. i pannelli in alluminio possono essere stampati o decorati con pellicole, prespaziati, vinili, ecc. i pannelli, così come i profili in alluminio anodizzato e gli angoli stampati a pressofusione, sono di alta qualità e duraturi nel tempo. pylo outdoor è disponibile in tre differenti larghezze.

DE pylo outdoor ist speziell für den aussenbereich gemacht: die bodenhalterung wird je nach untergrund angeschraubt oder einzementiert, die aluminium-paneele können sie je nach anforderung bedrucken oder kaschieren. sie sind wie die ebenfalls silber eloxierten aluminiumprofile sowie die veredelten metalldruckguss-ecken hochwertig und langlebig. erhältlich ist der pylo outdoor in drei verschiedenen breiten.

EN pylo outdoor is made especially for outdoor use: the ground sleeve can be fixed with screws or concrete according to your underground. the silver anodized aluminium panels can be printed or laminated. like the silver anodized profiles and the plated zinc aluminium alloy die-cast connectors they are robust and durable. the pylo outdoor is available in three different sizes.



print not included

pylo poster 700x500

pylo poster

MADE IN EU design by KD

IT pylo poster è il totem autoportante per la presentazione di informazioni facilmente sostituibili grazie alle tasche portaposter disponibili in tre diverse misure e munite di protezione trasparente flessibile in policarbonato resistente ai raggi ultravioletti.

DE freistehendes totem pylo poster für flexible informationpräsentation: mit beidseitigen poster-taschen erhältlich für drei gängige plakatsgrößen, ausführung wie pylo mit flexibler coverfolie aus uv-beständigem polycarbonat.

EN freestanding totem pylo poster for flexible information presentations: with poster pockets on both sides in the most common poster sizes. design and materials like pylo plus a flexible cover sheet made of uv-resistant polycarbonate.



facile e rapida apertura della custodia protettiva grazie al suo razionale design

schnelles und unkompliziertes öffnen und schliessen der cover folie dank cleverem design

quick and easy opening and closing of the cover sheet thanks to our clever design.

A pylo poster

	size*	
1	SO19PP700500	pylo poster 700x500mm, 1pc
2	SO19PPA1	pylo poster A1, 1pc
3	SO19PP1000700	pylo poster 1000x700mm, 1pc

* altezza x larghezza | höhe x breite | height x width

information

profili e pannelli: alluminio anodizzato color argento, angoli in pressofusione, zanche da terra in ferro zincato.

profile und paneele: silber eloxiertes aluminium, verbinder veredelter aluminiumdruckguss, bodenhülse eisen verzinkt

panel and profiles: silver anodized aluminium, connectors plated die cast aluminium alloy, ground sleeve zincated iron

- 1 400mm
- 2 600mm
- 3 800mm

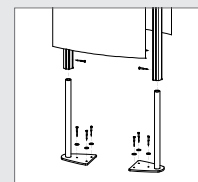

1900mm



A pylo outdoor

	size*	
1	SOPYO1900400	pylo outdoor 1900x400mm, 1pc
2	SOPYO1900600	pylo outdoor 1900x600mm, 1pc
3	SOPYO1900800	pylo outdoor 1900x800mm, 1pc

* altezza x larghezza | höhe x breite | height x width



ipoint

MADE IN EU design by KD

IT ipoint è il pratico totem fornito completo di due pannelli in alu bond colore argento e bianco opaco per la stampa digitale, che vi permetterà di creare la vostra grafica sia sul fronte che sul retro, dopo aver effettuato la personalizzazione, incollate i pannelli direttamente ai profili con del silicone o con un'altra colla adatta per quel tipo di materiale, inoltre, a scelta si possono aggiungere ripiani, barre laterali, accessori o altri moduli ipoint dalla linea soistes, chiedeteci e noi saremo sempre a disposizione per darvi ulteriori idee ed informazioni.

DE ipoint liefern wir ihnen mit zwei doppelseitig alu-verbundpaneel: silber und weiss matt für digitaldruck. sie können so selbst entscheiden wie sie jeweils die vorder- und auch die rückwand ihres ipoint gestalten. nach der personalisierung verkleben sie den ipoint mit silikon oder anderem geeigneten klebstoff direkt am profilrahmen. optional lassen sich ablagen, display bars oder weitere ipoint flächen ergänzen. fragen sie uns, wir beraten sie gerne.

EN ipoint comes complete with two double side aluminium composite panels: satin silver and matt white for digital printing, thus you can freely design front and rear side of your ipoint. after customizing the panels can be simply fixed with silicone or other glue to the profile frame. optionally you can add trays, display bars or further ipoint modules, just ask us, it is our pleasure to provide you with more ideas and further information.



connettore per strutture ipoint in zamac color argento
 verbinder für ipoint strukturen, versilberter metall druckguss
 connector for ipoint structures, silver plated die-cast metal

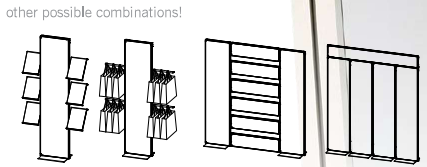

A	ipoint	size*
1	IP1900400ARW	ipoint 1900x400 silver/white, 1pc
2	IP1900600ARW	ipoint 1900x600 silver/white, 1pc
3	IP1400200ARW	ipoint 1400x200 silver/white, 1pc
4	IP1700200ARW	ipoint 1700x200 silver/white, 1pc
5	IPTCON	ipoint connector, set 2pcs

* altezza x larghezza | höhe x breite | height x width

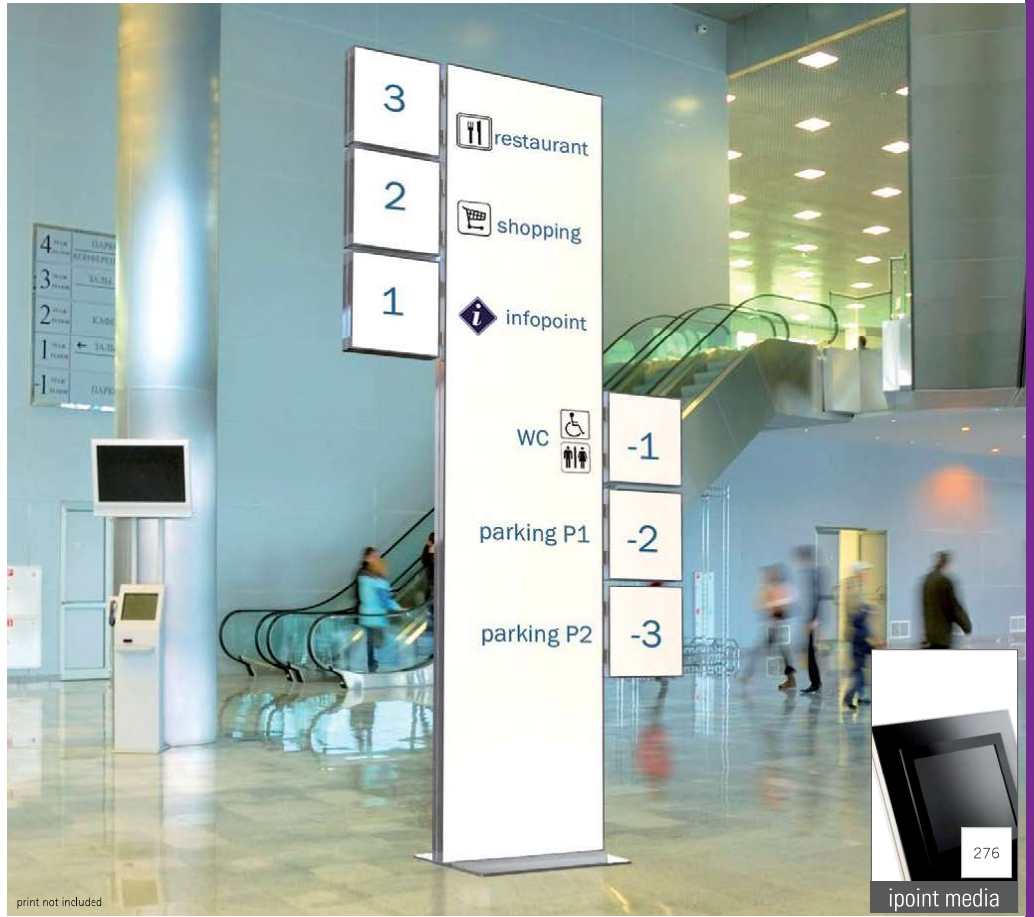

print not included

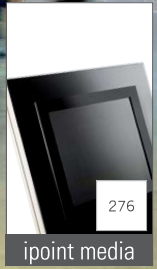

information

profili in alluminio anodizzato color argento, base metallica verniciata a polvere color argento, pannelli di alluminio composito color bianco opaco e argento, angoli in zamac color argento

silber elox-aluminium profil, basis metall silber pulverbeschichtet, alu-verbundpaneel mattweiss/silber, eckverbinder versilberter metall-druckguss

silver anodized aluminium extrusion, base silver coated metal, aluminium composite panel matt white/silver, edge connectors silver-plated die-cast metal

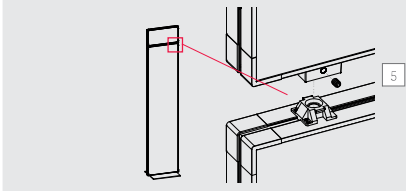
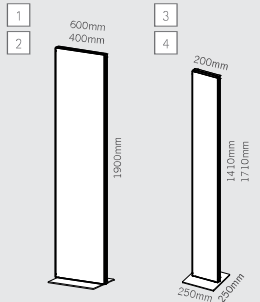

grazie ad ipoint connector il vostro espositore ipoint diventa modulare, basta inserire i dadi nei profili prima di effettuare il montaggio, in modo da poter aggiungere alla struttura tutta una serie di elementi in modo semplice e veloce.

modular wird ihr ipoint mit dem ipoint connector, vor der montage einfach die mutsteine einschrauben und schon können mehrere elemente ganz einfach verbunden werden.

make your ipoint modular with the ipoint connector, just slide in the nuts before mounting and thus you can very easily connect more elements to each other.

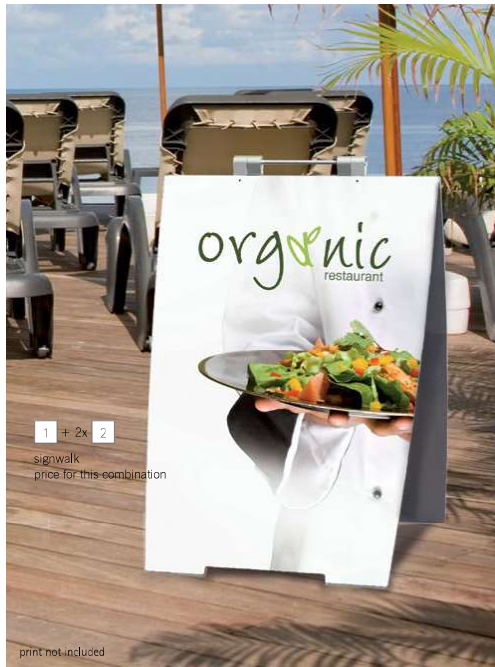

signwalk

MADE IN EU design by KD

IT con signwalk siete sempre in movimento: il design intelligente consente di unire 2 pannelli, per comporre un elegante display per interni ed esterni. signwalk può essere utilizzato anche per trasportare comodamente tutta la struttura, quando non lo utilizzate, chiudete i pannelli, in modo che i lati stampati vadano a trovarsi all'interno - per un trasporto o uno stoccaggio a prova di graffio, forniamo la struttura e anche i pannelli forex in color bianco.

DE mit signwalk jederzeit mobil: das clevere design verbindet 2 paneele zum kundenstopper für in- und outdoor, die verbindungsstange ist zugleich praktischer tragegriff, für transport und lagerung klappen sie beide paneele auf den bedruckten seiten bündig zusammen, so bleibt das decor kratzgeschützt. wir bieten ihnen die struktur sowie passende forex paneele in weiss.

EN with signwalk you are mobile: the clever design turns 2 panels into a display for in- and outdoor, the connector bar is a convenient carrying handle, for transport and storage just fold signwalk with the images inside and it will be protected against scratches. we offer you the structure and matching white forex panels as well.

ulteriori informazioni pag. 230
mehr details s. more information p.

A signwalk		size*
1	DSIW338 signwalk, panel excl., 1pc	
2	DSIW700500W panel white 700x500mm, 1pc	

* altezza x larghezza | höhe x breite | height x width

print not included



passboard

MADE IN CHINA quality control by KD

IT passboard diventa in un attimo un pratico display, basta semplicemente inserire il pannello stampato, una soluzione pratica ed economica per l'interno e l'esterno.

DE passboard entfaltet sich im nu zum praktischen präsentier, einfach paneel einschieben fertig, die ökonomische, mobile lösung für innen- wie aussenbereich.

EN passboard folds up in no time at all to a walkway display, simply insert the panel and here you go. an economic and mobile application for in- and outdoor.

ulteriori informazioni pag. 231
mehr details s. more information p.

A passboard		size*
3	DPAB1130 passboard, panel excl., 1pc	

print not included



maxiboard

MADE IN EU design by KD

IT un fantastico display per banner in tessuto: è possibile aprire il maxiboard per sostituire velocemente e in qualsiasi momento i banner in tessuto grazie alle strisce in silicone cucite sul banner stesso, tutti gli elementi che lo compongono sono realizzati in alluminio anodizzato di alta qualità in color argento, le parti metalliche sono stampate a pressofusione e i materiali sintetici ad iniezione.

DE ein toller kundenstopper für textile banner: das maxiboard lässt sich aufklappen, die textilen banner mit flachedersystem können jederzeit schnell gewechselt werden, alle teile sind aus hochwertigem silber-eloxiertem aluminium bzw. spritzguss aus metall und kunststoff.

EN a perfect A-board display for textile banners: the maxiboard is easily set up, the textile banners can be easily mounted using silicone strips, banner changing also is no big deal at all. all parts are made of high-grade silver anodized aluminium or die-cast parts made of metal and synthetics.

banner not included



information

profilo in alluminio anodizzato color argento, metallo stampato a pressofusione, stampa a iniezione dei materiali sintetici

silber eloxiertes alu-profil, metall-druckguss, kunststoff spritzguss

silver anodized aluminium profile, die-cast metal, die-cast synthetics

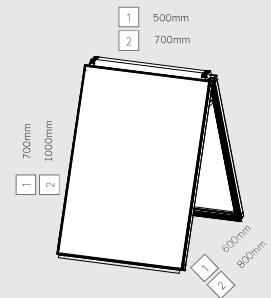

1	banner size: 720x520mm visible size: 700x500mm
2	banner size: 1020x720mm visible size: 1000x700mm

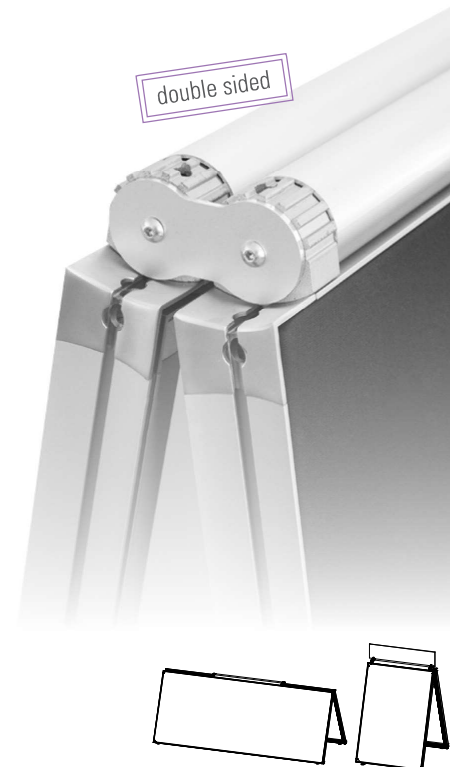

B maxiboard		size*
1	MXB700500 maxiboard 700x500mm, 1pc	
2	MXB1000700 maxiboard 1000x700mm, 1pc	

* altezza x larghezza | höhe x breite | height x width