

presentazione & portadepliant

IT dal classico portadepliant pieghevole ad innovativi espositori multifunzionali ideali per showroom, uffici e punto vendita - tutto ciò che serve per una presentazione d'effetto.

präsentation & prospektständer

DE vom klassiker - dem Klappbaren prospektständer - bis hin zu multifunktionalen info- und produktDisplays für showroom, office und POS, alles für die eindrucksvolle präsentation.

presentation & brochure holders

EN from the classic - our portable brochure holder - to the multifunctional information and product display for showroom, office and pos, everything for a spectacular presentation.



pixquick	pixquick silver	kite	pictures soistes	linfor linfor fly	flap	menu	budgetec printbadge
6	8	10	11	12-15	16	18	19

clear	taymar poster	snaprex snapin	twister quick	pirouette pylon	snaprex wood signcode table	twister box t-tray	taymar counter
20	21-23	24-27	28	29	30-31	32-33	34-37

taymar wall taymar infobox	scoop	magic board magic wall	dacapo dacapo maxi	ripiano	liftboy swift	flippy	smart menu smart floor glass mag
38-41	42	44-47	48-51	52	54-55	56	60-65

velo shark bag desk soistes	presstissimo wing velo velo magic	glass folder mosquito fixzip	solid zip sailzip	flashzip	zipack bigflash	flagflash magica	trend soistes palo soistes
66-71	72-77	78-83	84-87	88	90-91	92-93	94-95

kombi soistes compact soistes	rack minirack	cubic soistes	wallmate soistes	real zip flexi real zip	real bianco	real steel realbig	smartzip fixtable
96-99	100-101	102	103	104-106	108-111	112-115	116-117

show zip	zip dividers bags	double	magic zip magic accessories	turnpoint	dacapo ipoint	dacapo twist	tower dacapo four face
118	120-121	122	124-127	129	130	132	134-136



1 pixquick A8L

pixquick®

MADE IN EU design by KD patented

IT pixquick é ideale come espositore da banco o da parete, é a prova di polvere e non ha cornici laterali che impediscano la corretta visione dell'informazione. ideale soprattutto proprio per quelle informazioni che debbano essere cambiate frequentemente. pixquick si può aprire da entrambi i lati, semplicemente spostando il pannello frontale o togliendolo completamente: basta una leggera pressione sugli angoli. policarbonato di alta qualità ed un processo produttivo moderno e tecnologico garantiscono al prodotto design, durata di vita notevole, uniformità delle dimensioni ed un aspetto decisamente gradevole.

DE pixquick als funktioneller thekenaufsteller oder als wanddisplay präsentiert optimal auch häufig zu wechselnde infos, rahmenlos und staubgeschützt. zum öffnen kann das frontpaneel nach beiden seiten aufgeklappt oder komplett abgenommen werden. ein einfacher druck auf die ecken genügt. hochwertiges polycarbonat und produktionsverfahren nach dem letzten stand der technik garantieren ein langlebiges designprodukt mit masstreue und perfekter optik.

EN pixquick is a perfectly functional frameless and dust proof counter or wall display, ideal for information that has to be changed frequently, the front panel can be opened in either direction or removed completely by simply pushing the corners. high grade polycarbonate and a state-of-the-art production process guarantees a long-lasting design product and a perfect look.



6 pixquick A3

information

ruotare pixquick per cambiare facilmente formato da orizzontale a verticale e viceversa

im handumdrehen von vertikal auf horizontal umstellen

just rotate for vertical or horizontal position

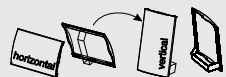

possibilità di diversi gradi di inclinazione cambiando la posizione del supporto da tavolo

verschiedene neigungen möglich durch verstellen der stütze

different inclinations by changing the support



per aprire sganciare o rimuovere il pannello frontale; A3: rimuovere completamente il pannello

zum öffnen frontpaneel aufklappen oder abnehmen; A3: frontpaneel nur komplett abnehmbar

to open: expand or remove front panel; A3: front panel only remove

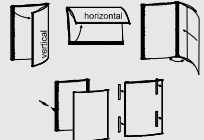

8 supporto da banco per formati A6 e A6L in PETG
stütze in PETG für format A6 und A6L
support for A6 and A6L made of PETG

9 supporto da banco per formato A8L in alluminio anodizzato color argento
stütze aus silber eloxiertem aluminium für format A8L
support for A8L made of silver anodized aluminium



1 + 9 pixquick A8L

information

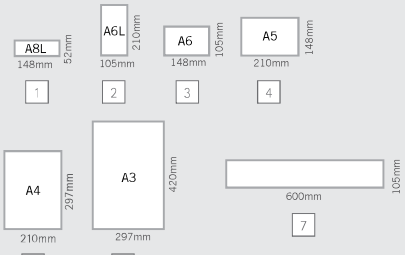

A pixquick

1	PQA8L***	pixquick A8L, without support, 1pc
2	PQA6L**	pixquick A6L, without support, 1pc
3	PQA6**	pixquick A6, without support, 1pc
4	PQA5	pixquick A5 support included, 1pc
5	PQA4	pixquick A4, support included, 1pc
6	PQA3	pixquick A3, without support, 1pc
7	PQ105600	pixquick 105x600mm, without support, 1pc
8	PQSA6PL	support for A6 and A6 large, 1pc
9	PQSA8LAL	support for A8L, 1pc

** ordinare supporto PQSA6PL a parte | stütze PQSA6PL extra bestellen | order support PQSA6PL extra
*** ordinare supporto PQSA8LAL a parte | stütze PQSA8LAL extra bestellen | order support PQSA8LAL extra



8 pixquick silver A3

pixquick® silver

MADE IN EU design by KD patented

IT pixquick, dal design brillante, apre nuovi scenari nell'ambito delle tecniche di presentazione ed esposizione. il pannello frontale può essere solo aperto oppure staccato completamente, garantendo così un cambio delle informazioni pratico e veloce. la chiusura di sicurezza è adatta anche per le persone mancine. grazie alla particolarità del design, le sue presentazioni saranno a prova di polvere e senza cornici laterali che impediscano la corretta visione del messaggio. il polycarbonato infrangibile e resistente ai raggi uv rende pixquick robusto e durevole, mentre la stampa ad iniezione garantisce l'uniformità delle dimensioni ed un'alta qualità del prodotto. particolarmente elegante, pixquick silver ha il retro verniciato di color argento metallizzato. come pixquick, anche pixquick silver è disponibile nei formati più comuni per il montaggio a parete.

DE pixquick mit seinem cleveren design eröffnet der präsentationstechnik neue dimensionen. das frontpaneel wird aufgeklappt oder ganz abgenommen und garantiert ebenso schnellen wie einfachen infoaustausch, der sicherheitsverschluss ist für links- und rechtshänder gleichermaßen geeignet. das besondere design präsentiert rahmenlos und staubgeschützt, schlagfestes und uv-beständiges polycarbonat macht pixquick langlebig und robust. masstreu und höchste produktqualität sichert das spritzguss-verfahren. besonders elegant ist pixquick silver mit seiner silbermetallic lackierten rückseite. erhältlich ist pixquick silver in den gängigsten formaten für die wandmontage.

EN pixquick's smart design opens new dimensions to presentation techniques. the removable hinged front panel guarantees quick and easy information exchange. the locking mechanism is suitable to both left and right-handed people. its special design presents frameless and dust proof information. shock and uv resistant polycarbonate renders pixquick long-lasting and robust. die casting ensures consistency of size and the highest product quality. pixquick silver is especially elegant with its metallic silver coated rear part. pixquick silver is available in most common sizes for wall mounting.

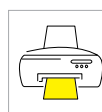

crei e stampi il layout semplicemente con il pc
lay out am eigenen pc gestalten und ausdrucken
design and print with your own workstation



A pixquick silver

1	PQARA8L***	pixquick silver A8L, 1pc
2	PQARA6L**	pixquick silver A6L, 1pc
3	PQARA6**	pixquick silver A6, 1pc
4	PQARA5	pixquick silver A5, 1pc
5	PQARA4	pixquick silver A4, 1pc
6	PQARA3	pixquick silver A3, 1pc
7	AVEN4040set	transparent suction cup, 4pcs
8	PQSA8LAL	support for A8L, 1pc

** ordinare supporto PQSA6PL a parte | stütze PQSA6PL extra bestellen | order support PQSA6PL extra
*** ordinare supporto PQSA8LAL a parte | stütze PQSA8LAL extra bestellen | order support PQSA8LAL extra

printbadge

9	PRB7832AR*	printbadge medium 32x80mm (hxl), 1pc
---	------------	--------------------------------------

! *nessuna distribuzione in e verso la germania
kein vertrieb in und nach deutschland
no distribution in o towards germany



4 pixquick silver A5



montaggio su vetro o altre superfici lisce facile e conveniente con le ventose.

montage auf glatten oberflächen mit saugnapfen einfach und bequem

mounting on smooth surfaces like glass with suction cups, easy and convenient



di aspetto elegante, in materiale sintetico metallizzato argento, a fissaggio magnetico particolarmente efficace

elegante optik in kunststoff silbermetallic mit sicherer extra starker magnetbefestigung

elegant look in silver metal with safe extra strong magnetic fastening

information

per aprire spingere o rimuovere il pannello frontale; A3: rimuovere completamente il pannello

zum öffnen frontpaneel aufklappen oder abnehmen; A3: frontpaneel nur komplett abnehmbar

to open: expand or remove front panel; A3: front panel only remove

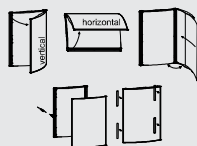

A8L	A6L	A6	A5	A4	A3
148mm	105mm	148mm	210mm	210mm	297mm
52mm	210mm	105mm	148mm	297mm	420mm
1	2	3	4	5	6



1 kite set 4x A4

kite

MADE IN EU design by KD



IT grazie a kite ha ora l'opportunità di creare con pixquick un sistema in sospensione su cavi di acciaio a soffitto o a parete, a scelta potrà acquistare il set completo con 4x A4 pixquick oppure ordinare e comporre liberamente le singole parti. anche in sospensione su cavi di acciaio, pixquick le garantisce una presentazione di informazioni o immagini a prova di polvere e senza cornici laterali.

DE mit kite können sie pixquick A4 oder A5 am seil wandmontieren oder abhängen. sie können das fertige 4x A4 set bestellen oder die einzelteile modular zusammenstellen. auch am seil präsentiert pixquick staubgeschützt und ohne störenden rahmen informationen oder bilder. der austausch ist jederzeit unkompliziert und schnell erledigt.

EN with the kite system you can wall mount or suspend pixquick A4 or A5. you can order the complete set with 4x A4 or combine the different parts modularly. even when suspended pixquick ensures a dust proof and elegant presentation of single sheet information without visible frame. change info sheet anytime easily and in no time at all.

pixquick per sistemi su cavo con supporti laterali; formati A5 e A4, policarbonato.

pixquick für seil incl. seilhalter, format A5 und A4, polycarbonat

pixquick for cable incl. supports, format A5 and A4, polycarbonate

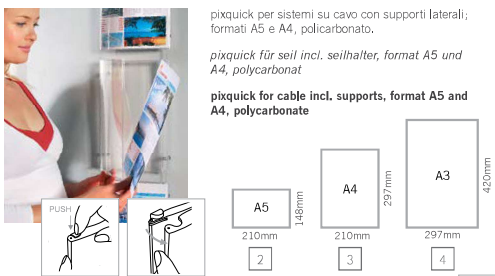

A kite

1	PQK4A4AR	kite set 4x A4 silver, 1 set	
2	PQCA5	pixquick A5 for kite, 1pc	
3	PQCA4	pixquick A4 for kite, 1pc	
4	PQCA3	pixquick A3 for kite, 1pc	

information

set completo per il fissaggio a parete o a soffitto composto da 4 pixquick A4, cavo di acciaio da 5mt, tiranti plusmini color argento e fly swing color argento.

komplettsset für wand- oder deckenabhängung mit vier A4 pixquick, stahlseil, befestigung plusmini silber und fly swing silber.

complete set for wall mounting or ceiling suspension of four A4 pixquick, steel cable, supports plusmini silver and fly swing silver.

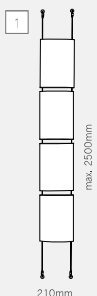

1 pictures soistes

pictures soistes

MADE IN EU design by KD



IT espositore mobile per poster, foto, immagini o informazioni di ogni tipo. 8 pixquick in formato A4 verticale, in tensione su cavi di acciaio, le offrono tanto spazio per idee creative e composizioni originali.

DE mobiles display für poster, fotos, bilder oder informationen jeder art. 8 am seil abgehängte pixquick für A4 format bieten jede menge platz für kreativen ideen und freie gestaltung.

EN mobile display for posters, photos, images or information of any kind. 8 wire suspended pixquicks of A4 size offers you a lot of space for creative ideas and stylish design.

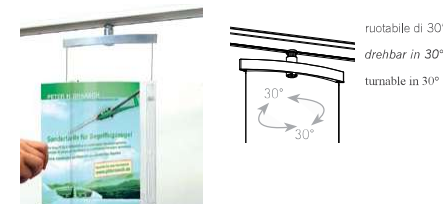

information

alluminio anodizzato color argento, policarbonato trasparente, zamac color argento

silber eloxiertes aluminium, transparentes polycarbonat, metalldruckguss versilbert

silver anodized aluminium, transparent polycarbonate, silver-plated metal die-cast

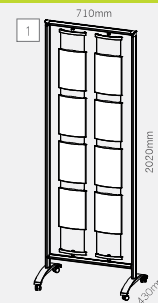

included

2

crownfix: morsetto per il montaggio di crown con uno spessore massimo di 4mm, ottone color argento.

crownfix: zur befestigung von topschildern mit max. 4mm stärke aus versilbertem messing.

crownfix: for crown panels mounting with max. 4mm thickness made of silver-plated brass.



A pictures soistes

1	SOPI2020*	pictures soistes, 1pc	
2	SOCF1515ARset	crownfix, set 2pcs	

* fino ad esaurimento scorte | solange vorrat reicht | while stock last



35
linfor A4 traffic white



montaggio con biadesivo trasparente.
befestigung mit transparentem doppelkleber.
mounting with transparent double adhesive tape.

information

I formati A4 e A3 possono anche essere montati sulla parete tramite delle viti.

die formate A4 und A3 können auch mit schrauben an die wand montiert werden.

the formats A4 and A3 can also be mounted on the wall using screws.



29
linfor A4 opal green

linfor

MADE IN EU design by KD

IT leggero di aspetto e di peso, linfor è la soluzione più conveniente e veloce per l'esposizione di fogli singoli, in particolare per applicazioni su superfici lisce. materiale plastico stampato ad iniezione, foglio protettivo flessibile e biadesivo trasparente: per una garanzia di tenuta, uniformità delle dimensioni ed un cambio veloce delle informazioni. linfor è disponibile nei formati DIN più comuni e oltre al colore trasparente è disponibile in diversi colori adatti alla segnaletica di sicurezza: blu segnale, rosso traffico, giallo zinco, verde opale.

DE schlank in optik und gewicht ist linfor die günstige und schnelle einzelblatt präsentation v.a. für montage auf glatten oberflächen, kunststoff-spritzguss mit flexibler cover-folie und transparentem doppelkleber garantieren masstreue und unkompliziertes auswechseln. erhältlich ist linfor in den gängigen DIN formaten und neben transparent in den passenden farben für sicherheitsbeschilderung: signalblau, verkehrsrot, zinkgelb, opalgrün.

EN lean design and light weight characterize linfor, the perfect low budget information presenter. it is best for mounting on smooth surface like glass. plastic die-cast with flexible cover sheet and transparent double adhesive tape guarantee accurate dimensions and easy exchange. linfor is available in the most common DIN formats. besides transparent we provide linfor in matching colours for security signage: signal blue, traffic red, zinc yellow and opal green.

A linfor

1	LINFORA8TR	linfor A8 transparent, 1pc
2	LINFORA7TR	linfor A7 transparent, 1pc
3	LINFORA6TR	linfor A6 transparent, 1pc
4	LINFORA5TR	linfor A5 transparent, 1pc
5	LINFORA4TR	linfor A4 transparent, 1pc
6	LINFORA3TR	linfor A3 transparent, 1pc
7	LINFORA8BL*	linfor A8 signal blue, 1pc
8	LINFORA7BL*	linfor A7 signal blue, 1pc
9	LINFORA6BL*	linfor A6 signal blue, 1pc
10	LINFORA5BL*	linfor A5 signal blue, 1pc
11	LINFORA4BL*	linfor A4 signal blue, 1pc
12	LINFORA3BL*	linfor A3 signal blue, 1pc
13	LINFORA8RS*	linfor A8 traffic red, 1pc
14	LINFORA7RS*	linfor A7 traffic red, 1pc
15	LINFORA6RS*	linfor A6 traffic red, 1pc
16	LINFORA5RS*	linfor A5 traffic red, 1pc
17	LINFORA4RS*	linfor A4 traffic red, 1pc
18	LINFORA3RS*	linfor A3 traffic red, 1pc
19	LINFORA8YE*	linfor A8 zinc yellow, 1pc
20	LINFORA7YE*	linfor A7 zinc yellow, 1pc
21	LINFORA6YE*	linfor A6 zinc yellow, 1pc
22	LINFORA5YE*	linfor A5 zinc yellow, 1pc
23	LINFORA4YE*	linfor A4 zinc yellow, 1pc
24	LINFORA3YE*	linfor A3 zinc yellow, 1pc



1
linfor A8 transparent



crei e stampi il layout semplicemente con il pc
layout am eigenen pc gestalten und ausdrucken
design and print with your own workstation

25	LINFORA8GR*	linfor A8 opal green, 1pc
26	LINFORA7GR*	linfor A7 opal green, 1pc
27	LINFORA6GR*	linfor A6 opal green, 1pc
28	LINFORA5GR*	linfor A5 opal green, 1pc
29	LINFORA4GR*	linfor A4 opal green, 1pc
30	LINFORA3GR*	linfor A3 opal green, 1pc
31	LINFORA8WH	linfor A8 traffic white, 1pc
32	LINFORA7WH	linfor A7 traffic white, 1pc
33	LINFORA6WH	linfor A6 traffic white, 1pc
34	LINFORA5WH	linfor A5 traffic white, 1pc
35	LINFORA4WH	linfor A4 traffic white, 1pc
36	LINFORA3WH	linfor A3 traffic white, 1pc

* fino ad esaurimento scorte | solange vorrat reicht | while stock last

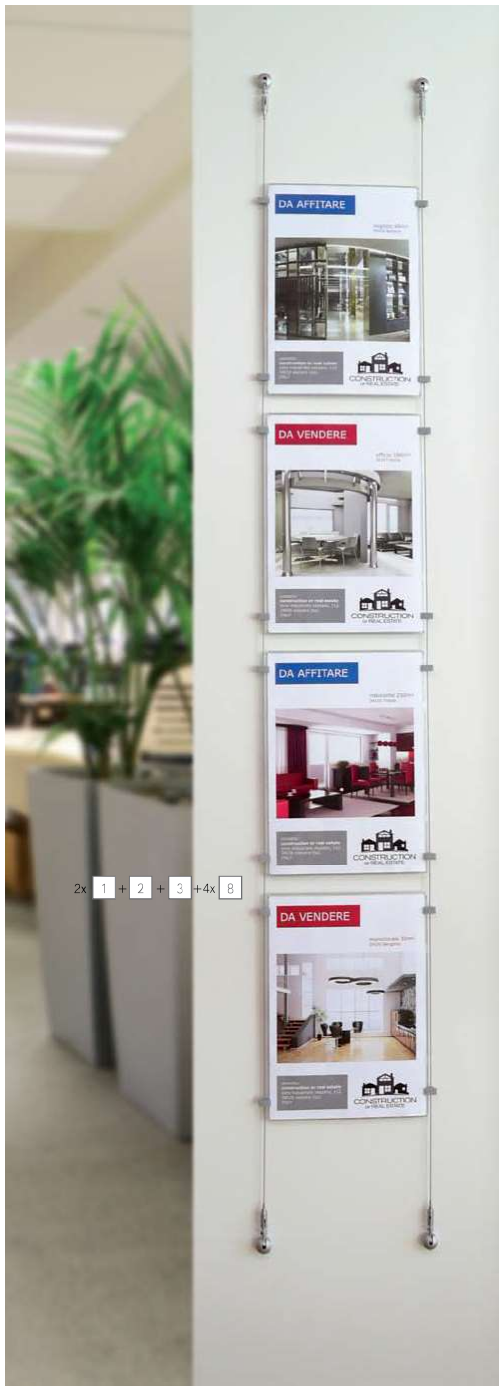

2x 1 + 2 + 3 + 4x 8

linfor fly

MADE IN EU design by KD

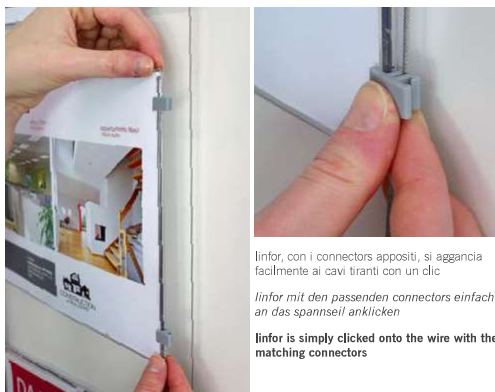

linfor, con i connectors appositi, si aggancia facilmente ai cavi tiranti con un clic
 linfor mit den passenden connectors einfach an das spannsel anklippen
 linfor is simply clicked onto the wire with the matching connectors

IT con linfor e il nostro sistema su cavi di acciaio fly potrà ottenere facilmente un ottimo sistema modulare di informazioni. le connector clips linfor si agganciano semplicemente sulle tasche portainformazioni linfor e sul cavo di acciaio, sono riutilizzabili e si possono spostare a piacere sul cavo di acciaio e sui linfor.

DE mit linfor und unserem spannselsystem fly können sie ganz einfach ein modulares informationssystem zusammenstellen. die linfor connector clips werden einfach an die linfor-infotaschen und das spannsel aufgeklipt, sie sind wiederwendbar und können beliebig angebracht werden.

EN with linfor and our cable rod system fly you can simply build modular information systems. the linfor connectors are simply clicked on to the linfor pockets and the wire, they are reusable and can be attached in any order.

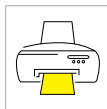

A linfor fly

1	YSW2060ARSET02	fly swing, set/2pcs
2	AFILIX05*	stainless steel Ø 1,2mm, 5m
3	LFCON20	linfor connector, 20pcs
4	LINFORA8TR	linfor A8 transparent, 1pc
5	LINFORA7TR	linfor A7 transparent, 1pc
6	LINFORA6TR	linfor A6 transparent, 1pc
7	LINFORA5TR	linfor A5 transparent, 1pc
8	LINFORA4TR	linfor A4 transparent, 1pc
9	LINFORA3TR	linfor A3 transparent, 1pc

* fino ad esaurimento scorte | solange vorrat reicht | while stock last



information

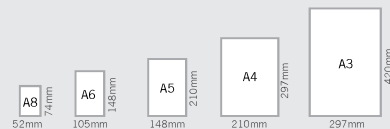

veloce e facile scambio delle informazioni
 informationsaustausch schnell und einfach
 information exchange quick and easy



supporto cavo, ottone cromato color argento satinato,
 seilhalter, messing silbermatt verchromt.
cable support, matt silver-plated brass.



cavo di acciaio rivestito di pvc, Ø1,2mm, 5mt.
 edelstahlseil pvc beschichtet, Ø1,2mm in edelstahl, 5mt.
stainless steel cable pvc coated Ø1,2mm stainless steel, 5mt.



connector clips per linfor e cavo di acciaio, in materiale plastico color grigio satinato,
 paneelhalter für linfor am spannsel, kunststoff grau satiniert.
panel support for linfor on wire, grey satin synthetics.



polycarbonato stampato ad iniezione, con foglio di protezione anteriore in pvc
 polycarbonat spritzguss mit flexibler pvc-abdeckfolie
polycarbonate die-cast with flexible cover in pvc

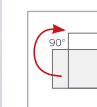



flap

MADE IN EU quality control by KD



IT pratico, veloce e trasparente: flap, la tasca porta informazioni brevettata può essere fissata su tutte le superfici tramite biadesivo. flap può essere perfettamente fissata anche su superfici lisce come il vetro. fissando la tasca internamente l'informazione è leggibile anche dall'esterno. il policarbonato stampato ad iniezione è antigraffio e garantisce una durata notevole del prodotto. il pannello frontale può essere semplicemente aperto sgangiando la parte superiore oppure staccato e rimosso completamente.

DE praktisch, schnell und transparent: die patentierte infotasche flap kann auf allen glatten flächen mit doppelkleber befestigt werden. speziell empfehlen wir flap für glas, da es sich perfekt doppelt nutzen lässt: innen montiert - von aussen und innen lesbar. der spritzguss aus polycarbonat ist langlebig und kratzfest, die frontabdeckung wird zum öffnen einfach leicht nach oben geschoben und wird dann aufgeklappt oder ganz abgenommen.

EN convenient, quick and transparent: the patented information pocket flap can be mounted to all smooth surfaces with transparent double adhesives. we recommend flap especially for glass, as it is perfectly for double use: mounted inside - visible from in- and outside. the polycarbonate die-cast is long-lasting and scratch resistant. to open it, just slide up gently the front cover and then you can swing it open or remove it completely.



montaggio con biadesivo trasparente.
befestigung mit transparentem doppelkleber.
mounting with transparent double adhesive tape.

A flap

1	FLAPA5V	flap A5 vertical, 1pc	
2	FLAPA5H	flap A5 horizontal, 1pc	
3	FLAPA4V	flap A4 vertical, 1pc	
4	FLAPA4H	flap A4 horizontal, 1pc	
5	FLAPA3H	flap A3 horizontal, 1pc	

3 flap A4 vertical



2 flap A5 horizontal

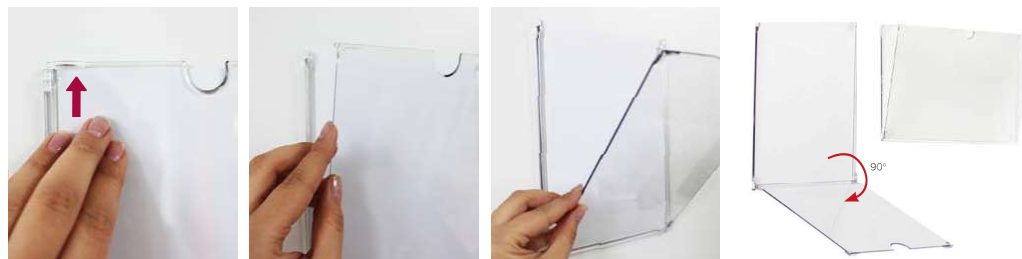

cambio delle informazioni
pratico e veloce
bedruckte info einfach und
schnell einlegen und jederzeit
bequem austauschen
your printed info is quickly and
easily exchangeable anytime



information

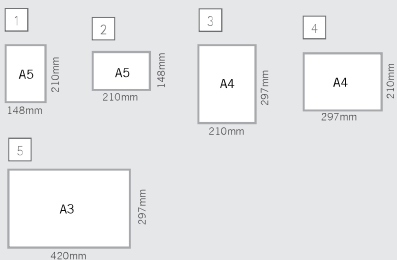



menu

MADE IN EU controlled by KD



IT pratico portalistino sfogliabile da parete per 10 fogli A4. ideale per menu, listini prezzi, orari di viaggio, istruzioni per il lavoro o per la sicurezza e tanto altro.

DE praktischer wandmontierter präsentier für 10 A4 seiten zum blättern. für speisekarten, preislisten, fahrpläne, arbeits- und sicherheitsanweisungen und vieles mehr.

EN convenient wall mounted display for 10 A4 pages. for menus, price lists, time tables, work or security instructions and much more.



per un cambio delle informazioni facile e veloce
einfacher und schneller infowechsel
quick and easy exchange of information

FOR
A4

A menu

1	ZMEN5A4WE	menu, 5 A4 double side, 1pc
---	-----------	-----------------------------

information

5 A4 (bifacciali) in materiale plastico bianco/nero, materiale per il montaggio incluso.

5 A4 doppelseitig kunststoff weiss/schwarz, incl. montage material.

5 A4 double sided plastic white/black, incl. mounting material.

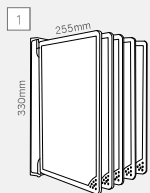

badgetec®

MADE IN GERMANY controlled by KD



badge leggero e tridimensionale grazie alla nuova tecnica di chiusura, fissaggio a spillo.

dreidimensionales, leichtes schild dank neuartiger klapp-technik. befestigung mit nadel.

lightweight three-dimensional badge with folding technique, attached with a safety pin.



robusto badge piatto in materiale plastico con chiusura magnetica.

robustes, flaches kunststoffschild mit integriertem kraftmagnet.

robust, flat badge with integrated strong magnet.



raffinato ed armonioso grazie al fissaggio magnetico e alla forma leggermente arrotondata.

passt sich durch die integrierte magnetbefestigung und leichte rundung harmonisch an.

thanks to the integrated magnet and its rounded shape the polar matches perfectly with every look.

single-box badgetec®, per custodire i suoi badge portanome o per i suoi biglietti da visita (max. 55x90mm).

single-box badgetec®, ist nicht nur für den schutz ihrer hochwertigen namensschilder geeignet, sondern auch für ihre visitenkarten (max. 55x90mm).

single-box made of satin synthetics and protects your name tags or your name cards (max. 55x90mm).



B badgetec®

	description	hxb
1	BPEV40TR	event 40, 37x75mm, 1pc
2	BPEV60TR	event 60, 54x85mm, 1pc
3	BPOF40AR	office „classic“, 37x75mm, 1pc
4	BPPO35AR	polar® „metal“, 34x74mm, 1pc
5	BPSBWE	single box, 1pc

printbadge

MADE IN CHINA controlled by KD



il badge squisitamente trendy in pregiato materiale sintetico nichelato e con efficace fissaggio magnetico.

trendiger badge in hochwertigem kunststoff mit extra starker magnetbefestigung.

trendy badge in high-grade nickel-plated finish with extra strong magnetic fastening.

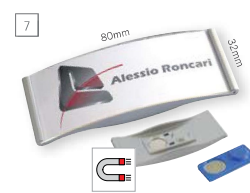

di aspetto elegante, in materiale sintetico metallizzato argento, a fissaggio magnetico particolarmente efficace.

elegante optik in kunststoff silbermetallisch mit sicherer extra starker magnetbefestigung.

elegant look in silver metal with safe extra strong magnetic fastening.

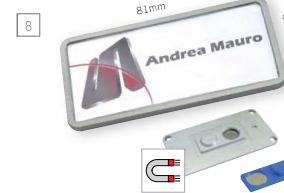

di formato avvincente, in materiale sintetico argentato, a fissaggio magnetico particolarmente efficace.

ansprechendes format in kunststoff silber mit extra starker magnetbefestigung

appealing format in silver with extra strong magnetic fastening

A printbadge small/medium/large

	hxb
6	PRB6315NI* nickel-plated, 15x62mm, 1pc
7	PRB7832AR* silver, 32x75mm, 1pc
8	PRB7537AR* silver, 37x75mm, 1pc

! * nessuna distribuzione in e verso la germania | kein vertreib in und nach deutschland | no distribution in or towards germany



2
clear A5

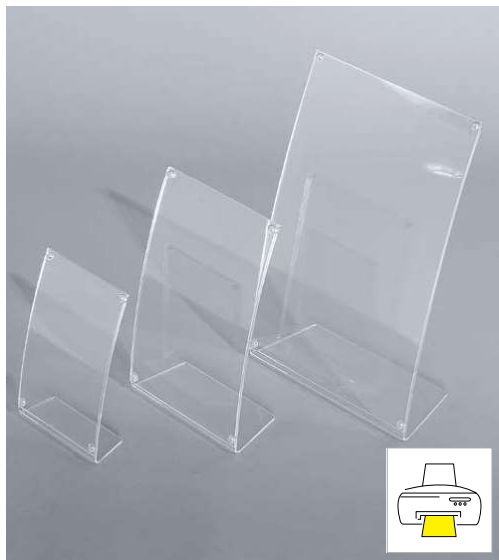

information



clear

MADE IN EU controlled by KD



IT tasca portainformazioni curva in acrilico trasparente. la tenuta della copertura è garantita dalle calamite e può essere facilmente rimossa per sostituire l'inserito. è predisposto per i formati più usuali, sia in orizzontale che in verticale.

DE gewölbte infotasche aus transparentem acryl. die abdeckung hält dank der magnete und kann zum infowechsel einfach abgenommen werden. clear kann vertikal wie horizontal aufgestellt oder gelegt werden. erhältlich in den gängigen formaten.

EN curved transparent acrylic information holder. the cover is kept firmly in place with magnets and can be easily removed to exchange the information on display. it comes in most common sizes, for vertical or horizontal use.

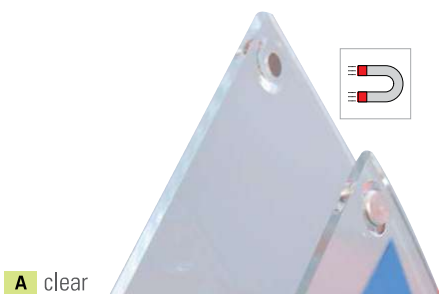

A clear

1	CLEA6	clear A6, 1pc
2	CLEA5	clear A5, 1pc
3	CLEA4	clear A4, 1pc



1
taymar poster single side A5

information

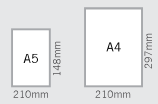

taymar poster single side

MADE IN EU controlled by KD



IT tasche portaposter monofacciali in polistirolo trasparente

DE postertaschen aus polystyrol mit einseitiger ansicht

EN poster pockets, single sided in polystyrene

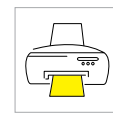

crei e stampei il layout semplicemente con il pc

layout am eigenen pc gestalten und ausdrucken

design and print with your own workstation



A taymar poster single side

1	TYAP150	poster A5, 1pc
2	TYAP210	poster A4, 1pc



3
taymar poster double side A5



2
taymar base 150mm



taymar poster double side

MADE IN EU controlled by KD

- IT** tasche portaposter bifacciali in polistirolo trasparente
- DE** postertaschen aus polystyrol mit beidseitiger ansicht
- EN** poster pockets, double sided in polystyrene

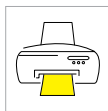

crei e stampi il layout semplicemente con il pc
 layout am eigenen pc gestalten und ausdrucken
 design and print with your own workstation

A taymar poster

description hxb

1	TYV100	poster 210x100mm, 1pc
2	TYV120*	poster 120x150mm, 1pc
3	TYV150	poster mono A5, 1pc
4	TYV210	poster mono A4, 1pc

* base 100mm | basislänge 100mm | base 100mm

information

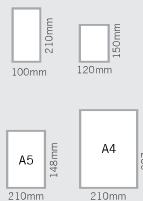

taymar poster base

MADE IN EU controlled by KD

- IT** base in polistirolo per porta informazioni di diverso tipo.
- DE** basis aus polystyrol für paneele verschiedener art.
- EN** base made of polystyrene for panels of different kinds.

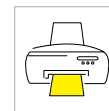

crei e stampi il layout semplicemente con il pc
 layout am eigenen pc gestalten und ausdrucken
 design and print with your own workstation

information

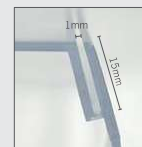

A taymar poster base

1	TYL100B	taymar base 100mm, 1pc
2	TYL150B	taymar base 150mm, 1pc



2 snaprex AG



set completo composto da base in acciaio inox e tasca in acrilico trasparente,

komplettes bestehend aus basis in edelstahl und einschubtasche aus transparentem acryl.

complete set: base made of stainless steel and transparent acrylic poster pocket.

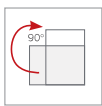

orizzontale o verticale: il formato si cambia semplicemente ruotando snaprex di 90°.

vertikal oder horizontal: einfach um 90° drehen.

vertical or horizontal: just turn 90° around.

snaprex

MADE IN EU design by fiveeyes and h&h



IT snaprex colpisce per il design accattivante e la molteplicità d'uso. metta nella tasca in acrilico trasparente qualsiasi informazione, foto, immagine o stampa, inserisca la tasca nella base in acciaio inox spazzolato e otterrà un display da banco raffinato ed elegante. la particolarità di snaprex: la base può essere utilizzata in verticale o in orizzontale, così come lo stesso display. qui di seguito troverà vari esempi pratici di applicazione.

DE snaprex besticht durch smartes design und vielfältigkeit in der anwendung. info, bilder, drucke in die transparenten acrylglas taschen einlegen. taschen auf die base aus gebürstetem edelstahl stecken. pfiffig dabei: die basis kann horizontal oder vertikal sitzen. snaprex selbst kann vertikal wie horizontal gestellt und sogar gelegt werden. unten auf der seite finden sie mögliche anwendungsbeispiele.

EN snaprex convinces with its smart design and vast diversity. insert information, images or prints into the poster pockets made of transparent acrylic, put the pockets into the brushed stainless steel base. smart: the base can be put either on horizontal or vertical side. snaprex itself can be used in every conceivable position. find examples for possible applications below.



A snaprex complete set

1	SNRA7	snaprex A7, 1 pc	
2	SNRA6	snaprex A6, 1 pc	
3	SNRA5	snaprex A5, 1 pc	
4	SNRA4	snaprex A4, 1 pc	
5	SNRA3	snaprex A3, 1 pc	



information

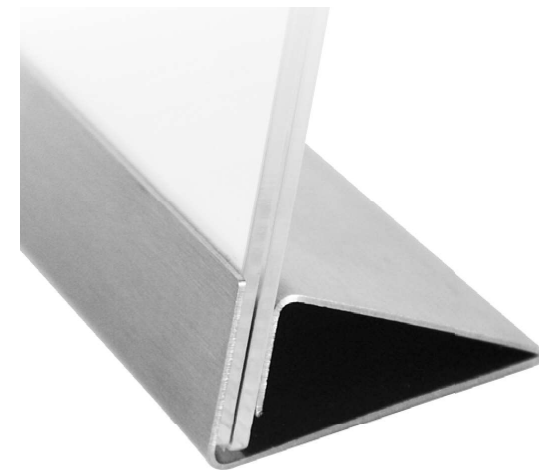
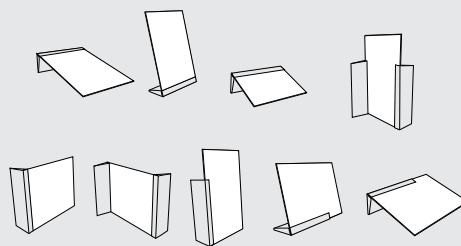

base in acciaio inox spazzolato
basis aus gebürstetem edelstahl
base made of brushed stainless steel

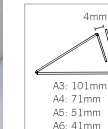

tasca in acrilico trasparente
infotasca aus transparentem acryl
poster pocket made of transparent acrylic

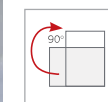

A snaprex base

1	SNRBA7	base steel 74mm, 1 pc	
2	SNRBA6	base steel 105mm, 1 pc	
3	SNRBA5	base steel 148mm, 1 pc	
4	SNRBA4	base steel 210mm, 1 pc	
5	SNRBA3	base steel 297mm, 1 pc	

A poster pockets

6	SNRTA7	poster pocket A7, 1 pc	
7	SNRTA6	poster pocket A6, 1 pc	
8	SNRTA5	poster pocket A5, 1 pc	
9	SNRTA4	poster pocket A4, 1 pc	
10	SNRTA3	poster pocket A3, 1 pc	



1
snapin 74mm

snapin

MADE IN EU design by KD

IT snapin è un profilo ad incastro in alluminio anodizzato color argento per pannelli rigidi di 4 mm di spessore. è possibile abbinarlo alle tasche snaprex oppure, dando sfogo alla creatività, lo si può utilizzare per inserirvi dei pannelli in alluminio composito stampati, i suoi usi sono molteplici, infatti può essere utilizzato come portanome, portaprezzi e portainformazioni di prodotti o anche come semplice cornice per le foto. snapin : un ottimo consiglio.

DE snapin ist ein silber eloxiertes aluminium-klemmprofil für 4mm starke platten. sie können es mit den snaprex einschubtaschen verbinden oder selbst kreativ werden und es z.b. für bedruckte alu-verbund-paneele nutzen, das einsetzgebiet ist vielfältig: ob als namensschild, preis- bzw. produktauszeichnung oder als bilderrahmen, mit snapin sind sie gut beraten.

EN snapin is a silver anodized aluminium extrusion for 4mm thick panels, you can use it together with our snaprex poster pockets or become creative yourself and use it for printed aluminium composite panels, the field of possible application is huge: e.g. as a name plate, as a price or product tag or as picture frame, with snapin you are always well advised.



personalizzabile
personalisierbar
customizable

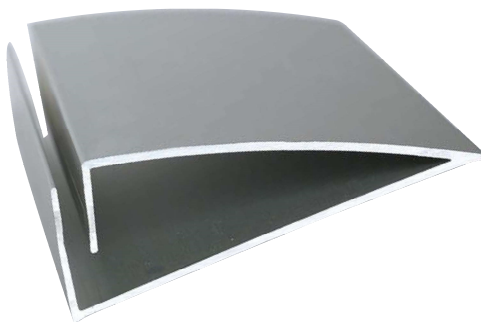
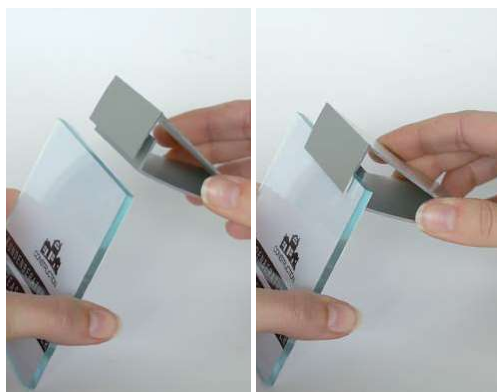

A snapin

1	SNIA7	snapin 74mm, 1pc
2	SNIA6	snapin 105mm, 1pc
3	SNIA5	snapin 148mm, 1pc
4	SNIA4	snapin 210mm, 1pc
5	SNIA3	snapin 297mm 1pc
6	SNI500	snapin 500mm 1pc

A poster pockets

7	SNRTA7	poster pocket A7, 1pc
8	SNRTA6	poster pocket A6, 1pc
9	SNRTA5	poster pocket A5, 1pc
10	SNRTA4	poster pocket A4, 1pc
11	SNRTA3	poster pocket A3, 1pc

information

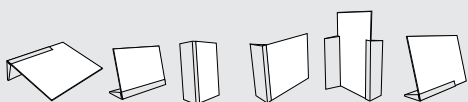

base in alluminio anodizzato color argento
basis aus silber eloxiertem aluminium
base made of silver anodized aluminium

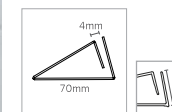

tasca in acrilico trasparente
infotasca aus transparentem acryl
poster pocket made of transparent acrylic

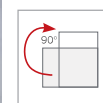

snapin si abbinna perfettamente con pannelli rigidi di 4 mm di spessore di qualsiasi materiale.

snapin kombiniert sich perfekt mit 4mm starken platten aus verschiedensten materialien.

snapin teams perfectly with 4mm thick panels made of various materials





3
twister quick A4
counter display for poster



information

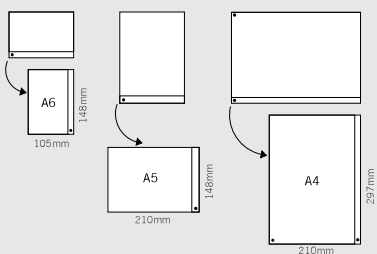

twister quick

MADE IN EU design by KD

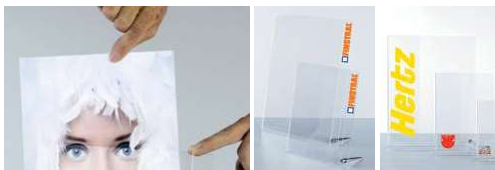

l'inserimento e il cambio dell'informazione sono facili e veloci. acrilico trasparente in combinazione con fissso desk, ideale per essere personalizzato con una stampa o con un adesivo.

info-einschub und wechsel schnell und bequem. transparentes acryl in kombination mit fissso desk. ideal für customizing mit druck oder aufkleber.

insert and exchange any information quick and easily, transparent acryl in combination withfisso desk, perfect for customizing with print or adhesive labels.

IT twister quick é semplice e comodo: basta inserire il foglio di informazioni nella tasca per un'efficace presentazione da banco o da tavolo, orizzontale o verticale: basta girarlo e potrà esporre le sue informazioni nel formato che desidera, veloce e flessibile, twister quick é ideale per listini, menu, stampe, foto, cartine, pubblicitá o per altre indicazioni. si puó anche personalizzare: basta stampare la scritta desiderata sul bordo laterale per avere un ulteriore vantaggio pubblicitario. TWISTER – che carattere!

DE information jeder art einfach in die postertasche einschieben und sofort wirkungsvoll auf theke, counter, tisch und bord präsentieren. ob horizontal oder vertikal: ein dreh genügt und schon haben sie ihr gewünschtes format. einfach, schnell und flexibel ist TWISTER QUICK ideal für preislisten, menü- oder tischkarten, bilder, fotos, fahrpläne, werbung und andere hinweise. auch customizing ist kein problem: das gewünschte label auf den seitlichen rand drucken und den zusätzlichen werbevorteil nutzen. TWISTER - dieser dreh hat format!

EN insert information of any kind simply into the poster pocket and display it strikingly right away on counter, bar, table or shelf. horizontal or vertical? with just one simple turn you get what you need. simple, quick and flexible in handling makes TWISTER QUICK your display for price lists, menu or place cards, name plates, images, pictures, timetables, ads and other information. make use of even more publicity and customize your TWISTER: just print the requested label on the lateral border. TWISTER - your turn for the better.



A twister quick



1	TWQA6	twister quick A6, 1pc	
2	TWQA5	twister quick A5, 1pc	
3	TWQA4	twister quick A4, 1pc	



1
pirouette A6L

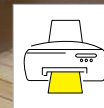

pirouette

MADE IN EU design by KD

IT espositore da banco girevole con 3 pixquick A4, A6L o A6, base nera.

DE frei drehbares thekendisplay mit 3 pixquick A4, A6L oder A5, schwarzer fuss.

EN freely rotating counter display with 3 pixquick A4, A6L or A5, black base.

information

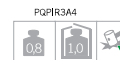
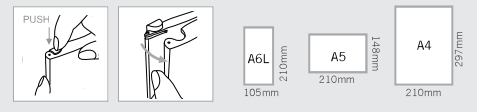

A pirouette

1	PQPIR3A6L	pirouette A6L, 1pc	
2	PQPIR3A5	pirouette A5, 1pc	
3	PQPIR3A4	pirouette A4, 1pc	



4
pylon A4

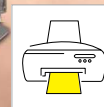

pylon

MADE IN EU design by KD

IT espositore da banco bifacciale con due pixquick A4,A6L o A5, base in alluminio anodizzato color argento.

DE doppelseitiger thekenaufsteller mit zwei pixquick A4, A6L oder A5, silber eloxierte aluminiumbasis.

EN double sided counter display with two pixquick A4, A6L or A5, silver anodized aluminium base.

information

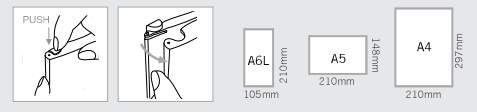

A pylon

4	PQPYA6L	pylon A6L, 1pc	
5	PQPYA5	pylon A5, 1pc	
6	PQPYA4	pylon A4, 1pc	



3
snaprex wood A4



information

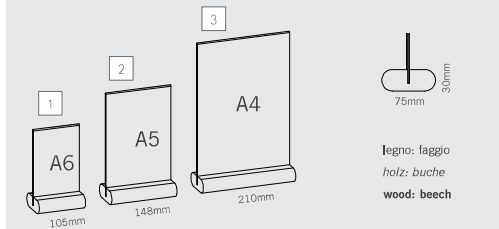

legno: faggio
holz: buche
wood: beech

snaprex wood

MADE IN EU design by KD

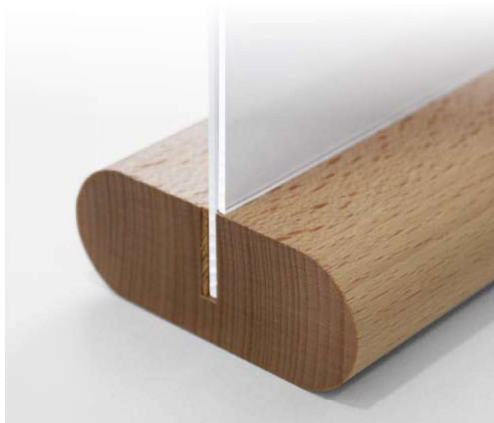

IT il legno incontra l'acrilico: snaprex wood espositore da tavolo bifacciale stupisce grazie alla base elegante e alla sua tasca in acrilico di eccellente resistenza. una soluzione perfetta per inserire fogli singoli che potrà stampare dal suo computer personale e cambiare velocemente e in qualsiasi momento. un sistema ideale e di aspetto naturale per esporre menu, informazioni e listini in albergo, sul punto vendita e in showroom.

DE holz trifft acryl: der doppelseitige tischaufsteller snaprex wood punktet mit seiner eleganten holzbasis und einer klassischen info-tasche aus acryl. hier können einzelblätter, die sie einfach am eigenen pc gestalten, schnell und einfach eingesetzt und jederzeit getauscht werden. der zweiseitige aufsteller snaprex wood für tisch und theke ist der ideale info-, menü- und preisschildhalter im hotel, restaurant, geschäft und showroom.

EN wood meets acrylic: the double-sided counter display snaprex wood scores with its elegant wooden base and its classic information pocket made of acrylic. you can insert single sheets quickly and easily and change them easily anytime you want. the two sided display for counter and desk is perfect as information holder, as menu and price tag for hotels, restaurants, shops and showrooms.

create e stampate il layout semplicemente con il pc
layout am eigenen pc gestalten und ausdrucken
design and print with your own workstation

A snaprex wood

1	SNLA6	snaprex wood A6, 1pc
2	SNLA5	snaprex wood A5, 1pc
3	SNLA4	snaprex wood A4, 1pc

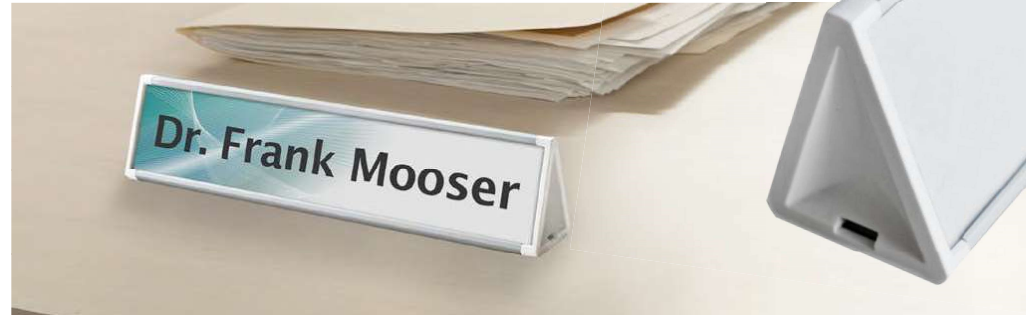

semplicità di inserimento dell'informazione per materiale con spessore fino a 1,5mm

einfacher info-ein Schub für material mit einer stärke bis zu 1,5mm

easy information exchange system - for materials with max. 1,5mm thickness

dover aver inserito l'informazione basta aggiungere il protettivo in ps

papier-info ist mit der transparenten abdeckung perfekt geschützt

paper information is perfectly protected with the transparent cover



grazie alla chiusura di sicurezza la vostra info è a prova di manomissione

dank des sicherheitsverschlusses ist ihre info vor manipulation geschützt

thanks to the safety lock system your information is tamper proof

information

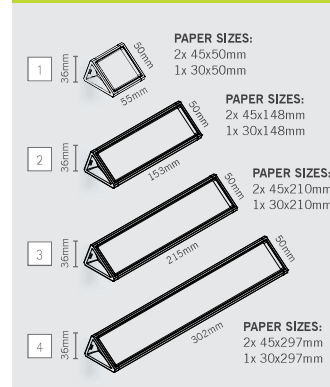

choice of colors

AC	BR
RAL 7016	RAL 8019
RE	YE
RAL 3020	RAL 1023
LG	WH
RAL 7035	RAL 9016
BL	GR
RAL 5005	RAL 6024

signcode table

MADE IN EU design by kd

IT perfetto come espositore porta nome o porta informazioni, ideale come porta prezzi in vetrina o per banconi quando si vuole cambiare da "aperto" a "chiuso". il profilo triangolare signcode table con tre superfici porta informazioni è la soluzione migliore se si è alla ricerca di un supporto flessibile, robusto e di ottima qualità, il cambio dell'informazione è velocissimo: basterà rimuovere uno dei tappi laterali e inserire il supporto sotto il protettivo in ps, il porta nome o porta informazioni da tavolo è provvisto di un sistema antimanomissione. vorrebbe riceverlo colorato? nessun problema, i tappi di chiusura in abs sono disponibili in grigio antracite, marrone, blu, verde, rosso, giallo, grigio luce e bianco traffico.

DE signcode table: das praktische info-, werbe- und namensschild bei konferenzen, im büro, zur preisauszeichnung in auslagen, schaufenstern oder am schalter. sie wechseln im handumdrehen „geöffnet“ auf „geschlossen“ oder eine werbung. signcode table bietet ihnen mit dreiseitig personalisierbarer fläche ein 3-in-1-produkt. der info-austausch erfolgt blitzschnell: mit dem schlüssel eine seitliche abdeckkappe lösen und abnehmen, die transparente abdeckung herausziehen, die neue info mit der abdeckung einschieben, kappe aufsetzen – fertig! der sicherheitsverschluss schützt ihre info vor manipulation. das profil ist silbermatt eloxiertes alu und die abdeckkappen gibt es in vielen modernen farben.

EN signcode table: the convenient name plate, information display and publicity space for conferences, office, price tagging in show cases, shop windows and counters. in just one turn you easily switch from „open“ to „closed“ or a publicity. signcode table with its three customizable sides provides you with a 3-in-1-product. the exchange of the information is done in no time at all: open with the key one side cap and take it off, pull out the transparent cover, insert the new print and the cover, put side cap on - done! the safety lock makes signcode table tamper-proof. the profile is silver matt anodised aluminium and the side caps are available in many trendy colours.

A signcode table

1	SCT50AL	signcode table 50mm, 1pc
2	SCT148AL	signcode table 148mm, 1pc
3	SCT210AL	signcode table 210mm, 1pc
4	SCT297AL	signcode table 297mm, 1pc

A signcode table color

1	SCTY50	signcode table color 50mm, 1pc
2	SCTY148	signcode table color 148mm, 1pc
3	SCTY210	signcode table color 210mm, 1pc
4	SCTY297	signcode table color 297mm, 1pc

*) Inserire la sigla del colore nel campo bianco | farbcodes im weißen feld eintragen | insert the colour code in the blank space

2

twister box A5
counter display for brochures



information

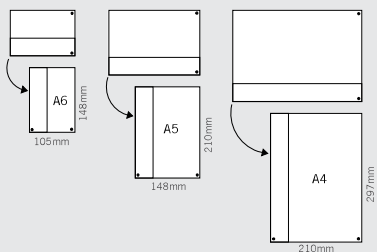

twister box

MADE IN EU design by KD



Il montaggio con fisso desk è facile e veloce e i depliant di ogni formato sono a portata di mano, adatto per la personalizzazione con la stampa o con un adesivo.

montage mit fisso desk schnell und einfach, bequeme entnahme aller formate, passend zu personalisieren durch aufdruck.

mounting is quick and easy with fisso desk, convenient for take out of all sizes, easy to customize with print.

IT tutto ciò che deve essere a portata del pubblico come depliant, cartine, brochure, opuscoli trova splendidamente posto in twister box. c'è del nuovo materiale con un formato diverso? nessun problema, la flessibilità è dalla sua parte: basta ruotarlo e twister box diventa orizzontale da verticale o viceversa. migliori il suo marketing e stampi il bordo laterale di twister box, a seconda delle informazioni che andrà ad esporre. TWISTER – flessibilità per ogni formato.

DE jegliche info zum mitnehmen, wie prospekte, karten, brochüren, flyer oder hefte, findet in TWISTER BOX platz. neues material mit anderem format? kein problem, sie sind flexibel: mit einem dreh lässt sich auch TWISTER BOX von vertikal auf horizontal umstellen. steigern sie Ihr marketing und bedrucken sie passend zum angebotenen print-material die TWISTER BOX mit dem entsprechenden label. TWISTER - flexibilität mit format!

EN any information for take-away like brochures, maps, flyers or booklets, has its place in the TWISTER BOX. new brochures with different size? no problem, you stay flexible: with a simple turn you can change the TWISTER BOX as well from horizontal to vertical. increase your marketing advantage and label your TWISTER BOX with print. TWISTER - your turn to the right side.



A twister box

1	TWBA6	twister box A6, 1pc	
2	TWBA5	twister box A5, 1pc	
3	TWBA4	twister box A4, 1pc	

t-tray

MADE IN EU design by KD



IT pratico, stabile e flessibile: il nostro t-tray, stampato ad iniezione in policarbonato, resistente ai raggi UV ed infrangibile, è l'ideale per presentazioni da banco. i sostegni laterali si girano semplicemente all'indietro. il pratico divider trasforma il t-tray in un display per 2 depliant formato A6

DE praktisch, robust und vielfältig: unser transparenter tischauflager t-tray aus uv-beständigem und schlagfestem polycarbonat spritzguss, die stütze wird einfach eingeklickt. der praktische divider macht aus dem A4-fach im bedarfsfall durch einschub platz für zwei A6 fächer.

EN convenient, stable and flexible: the transparent counter display t-tray made of uv- and shock-resistant die-cast polycarbonate. the support is simply clicked in, the handy divider turns your A4 tray in a presenter for 2 A6 trays.



zip divider restyle: divisore in acrilico trasparente per due depliant DIN A6 verticali, sistemati uno di fianco all'altro

zip divider restyle: transparentes acryl, unterteiler für prospekttasche in 2 A6 fächer

zip divider restyle: transparent acrylic, divides the A4 brochure pocket into 2 A6 trays

information

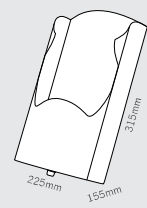

A t-tray

1	TTRAY *	counter display 1x A4, 1pc	
2	DNZIPO2	zip divider restyle, set 2pcs	



* fino ad esaurimento scorte | solange vorrät reicht | while stock last



12 pocket A4 horizontal



1 espositore per biglietti da visita orizzontale
visitenkartendisplay horizontal
display for business cards horizontal



2 espositore per biglietti da visita verticale
visitenkartendisplay vertical
display for business cards vertical



3 espositore da banco A5.
thekenaufsteller für A5.
counter display A5.

information

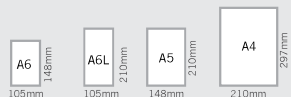

taymar counter single

MADE IN EU controlled by KD

IT tasca portadepliant da banco e tavolo, in polistirolo trasparente, modello 8-14 con fori per il pratico montaggio a parete.

DE prospektdisplay aus polystyrol zum aufstellen für counter und theke, modelle 8 bis 14 mit bohrungen für die praktische wandmontage.

EN counter or table top brochure holder in polystyrene, model 8-14 with holes for convenient wall mounting.

A taymar counter single

1	TYBC93	card holder horizontal, 1pc
2	TYVBC56	card holder vertical, 1pc
3	TYC160	pocket A5, 1pc
4	TYC110	pocket A6, 1pc
5	TYC230	pocket A4 vertical, 1pc
6	TY2C112	pocket 2xA6L, 1pc
7	TYTS160*	pocket A5, 1pc
8	TYTS230*	pocket A4, 1pc
9	TYCLA5	pocket A5 horizontal, 1pc
10	TY2C155H	pocket 2xA5, 1pc
11	TY3C110H	pocket 3xA6L, 1pc
12	TYC330	pocket A4 horizontal, 1pc

* fino ad esaurimento scorte | solange vorrat reicht | while stock last



4 espositore da banco A6.
thekenaufsteller für A6.
counter display A6.



5 espositore da banco A4.
thekenaufsteller für A4.
counter display A4.



6 espositore da banco 2xA6L.
thekenaufsteller für 2xA6L.
counter display 2xA6L.



7 espositore da banco e da parete A5.
aufsteller für theke oder wand A5.
display for wall and counter A5.

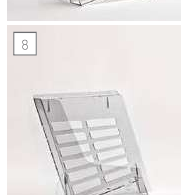

8 espositore da banco e da parete A4.
aufsteller für theke oder wand A4.
display for wall and counter A4.



9 espositore da banco e da parete A5.
aufsteller für theke oder wand A5.
display for wall and counter A5.



10 espositore da banco e da parete 2xA5.
aufsteller für theke oder wand 2xA5.
display for wall and counter 2xA5.



1 card holder horizontal



11 espositore da banco e da parete 3xA6L.
aufsteller für theke oder wand 3xA6L.
display for wall and counter 3xA6L.



12 espositore da banco e da parete A4 orizzontale.
aufsteller für theke oder wand A4 horizontal.
display for wall and counter A4 horizontal.



3
pocket 3xA5



1

espositore da banco e da parete 2xA5,
aufsteller für theke oder wand 2xA5.
display for wall and counter 2xA5.



2

espositore da banco e da parete 2xA4,
aufsteller für theke oder wand 2xA4.
display for wall and counter 2xA4.



3

espositore da banco e da parete 3xA5,
aufsteller für theke oder wand 3xA5.
display for wall and counter 3xA5.

information

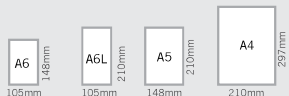

taymar counter multi

MADE IN EU controlled by KD

IT tasche portadepliant multiple da banco in polistirolo trasparente, modello n° 1, 2, 3, 4, 7 e 8 con fori per il montaggio a parete.

DE prospekt-displays aus polystyrol für counter, tisch und theke. model nr. 1, 2, 3, 4, 7 e 8 mit löchern für mögliche wandmontage.

EN counter or table top multiple brochure holder in polystyrene. model nr. 1, 2, 3, 4, 7 e 8 with holes for wall mounting.

A taymar counter multi

1	TY2C160	pocket 2xA5, 1pc
2	TY2C230X*	pocket 2xA4, 1pc
3	TY3C160	counter multi 3xA5, 1pc
4	TY4C160	pocket 4xA5, 1pc
5	TY4C110	pocket 4xA6L, 1pc
6	TY3C230	pocket 3xA4, 1pc
7	TY4C230X	pocket 4xA4, 1pc
8	TYCD*	divider for A4 pockets in 2xA6L, 1pc

* fino ad esaurimento scorte | solange vorrat reicht | while stock last



4
pocket 4xA5

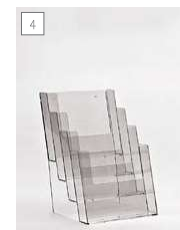

4

espositore da banco e da parete 4xA5,
aufsteller für theke oder wand 4xA5.
display for wall and counter 4xA5.



5

espositore da banco 4xA6L,
thekenaufsteller für 4xA6L.
counter display 4xA6L.



6

espositore da banco 3xA4,
thekenaufsteller für 3xA4.
counter display 3xA4.



7

espositore da banco e da parete 4xA4,
aufsteller für theke oder wand 4xA4.
display for wall and counter 4xA4.



8

divisore per espositori da A4 in 2xA6L
unterteilung für A4 aufsteller in 2xA6L.
divider for A4 displays in 2xA6L.

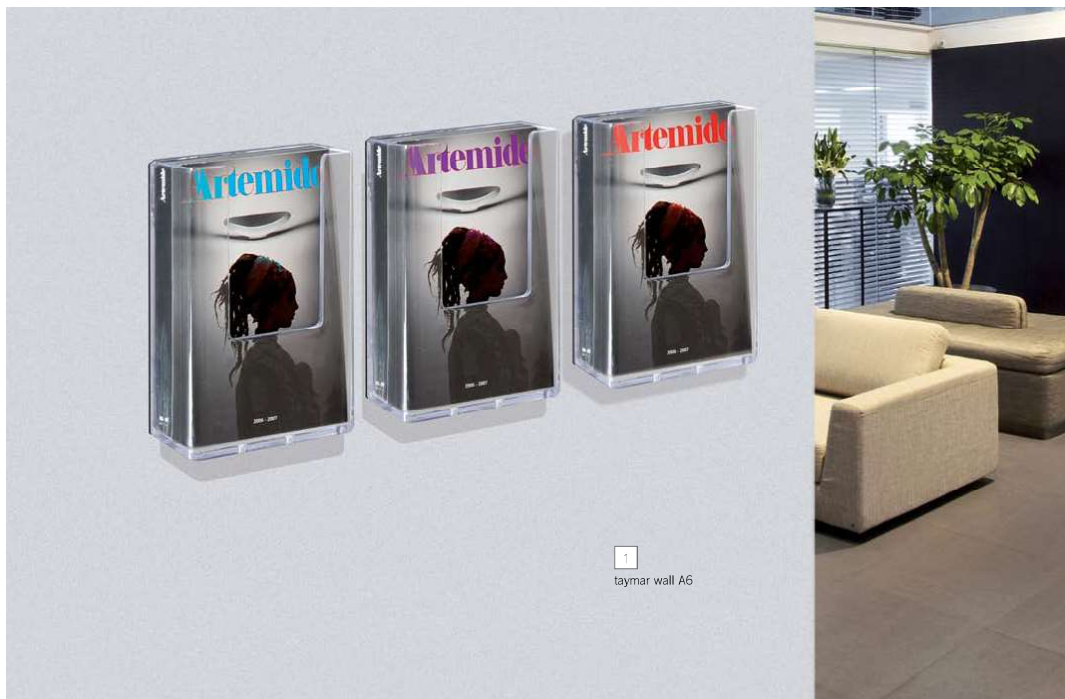

1
taymar wall A6



5
taymar wall 3xA4



4
taymar wall 2xA5



espositore da parete A6,
wanddisplay A6,
display for wall A6,



espositore da parete A5,
wanddisplay A5,
display for wall A5,



espositore da parete A4,
wanddisplay A4,
display for wall A4,

taymar wall

MADE IN EU controlled by KD

IT libertà di composizione per un budget modesto: il consiglio è di utilizzare i portadocumenti in polistirolo trasparente, per un montaggio diretto a parete, gli espositori singoli sono disponibili nei formati DIN più comuni.

DE freie gestaltung für wenig budget: da empfehlen sich diese prospektaschen aus transparentem polystyrol für die direkte wandmontage, die ein-fach displays sind in gängigen DIN formaten erhältlich.

EN free arrangement for low budget? then we suggest the transparent polystyrene brochure pockets for direct wall mounting, the single tray displays are available in common DIN formats.

A taymar wall

1	TYW110X	pocket A6, 1pc
2	TYW160X	pocket A5, 1pc
3	TYW230X	pocket A4, 1pc
4	TY2W155H	pocket 2xA5 vertical, 1pc
5	TY3W230	pocket 3xA4, 1pc

information

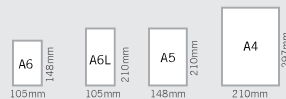

4
espositore da parete 2xA5 verticale,
wanddisplay 2xA5 vertical,
display for wall 2xA5 vertical.



espositore da parete 3xA4,
wanddisplay 3xA4,
display for wall 3xA4,



taymar infobox

MADE IN EU controlled by KD



IT pratico espositore adatto anche per l'esterno: in questo box trasparente troveranno posto informazioni di qualsiasi formato, dall'A4 al biglietto da visita. di particolare interesse è la protezione dalla pioggia, ragione per cui potrà utilizzare l'espositore anche all'esterno.

DE praktisches display auch für den außenbereich: in dieser transparenten box finden von visitenkarten bis hin zu A4-prospekten jede menge infos platz. der clou: der inhalt ist spritzwassergeschützt, so können sie dieses display auch im außenbereich verwenden.

EN convenient display - also for outdoors: in this transparent box you can display any information starting from name cards up to A4 sized brochures. the chief attraction is that the contents are splash-proof stored, and therefore this infobox can be used even outdoors.



adatto per fogli singoli o per dépliant, basterà aprire l'aletta, prendere ciò che si desidera e richiuderla!

geeignet für einzelblatt oder für prospekte, klappe öffnen und einfach rausnehmen!

suitable for flyers and brochures as well. simply open the cover and take out the information.



4 taymar infobox A4



nessuna infiltrazione d'acqua grazie al design intelligente

kein eindringen von wasser dank cleverem design

the clever design protects the content from water

invito "please take one" sulla parte superiore dell'aletta

einladung zur entnahme „please take one“ im deckel

friendly invitation for take away in the cover: "please take one"

information

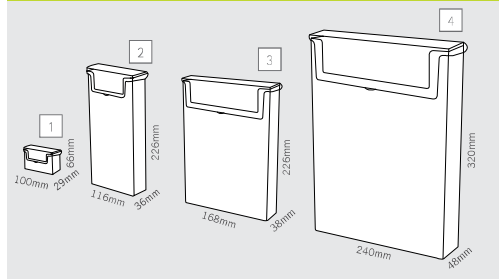

A taymar infobox

	description hxb
1	TYOD95 taymar infobox card holder 85x55mm, 1pc
2	TYOD110 taymar infobox A6L, 1pc
3	TYOD160 taymar infobox A5, 1pc
4	TYOD230 taymar infobox A4, 1pc



1
scoop traffic purple

scoop

MADE IN EU design by KD



IT scoop color l'atmosfera! l' elegante ed intramontabile portariviste da parete è adatto per ogni reception, sala d'attesa e negozio che voglia mostrare carattere e comunicare passione per il design. grazie a scoop potrete dire addio a cataste di riviste e giornali e a scatole ingombranti. montato alla parete in un batter d'occhio, scoop ospita nelle sue 4 tasche giornali e riviste di varie grandezze. bianco elegante, verde foglia o porpora chic: scoop è una soluzione d'alta qualità che stupisce al colpo d'occhio.

DE farbe bekennen mit scoop! der elegante und zeitlose wand-zeitungshalter passt in jeden empfangsbereich, wartesaal, salon und alle weiteren ambiente. scoop räumt auf mit chaotischen zeitungstapeln und platzraubenden boxen: er kann im handumdrehen an die wand befestigt werden und verstaut in seinen 4 taschen zeitungen und zeitschriften verschiedenster großen fein säuberlich und platzsparend, ob in elegantem weiß, frischem grün oder schickem purpur: der hochwertige scoop ist ein garantierter blickfang!

EN scoop makes the atmosphere coloured! this elegant and timeless newspaper rack for walls is suited to each reception area, waiting room, lounge and location with the need to communicate passion for design. scoop gets rid of chaotic piles of newspapers and bulky boxes: it can be fixed on the wall in the blink of an eye and stows in its 4 pockets newspapers and magazines of various formats and sizes. whether you like it in elegant white, fresh green or chic purple: the high quality news rack scoop always works as a real eye catcher!

information

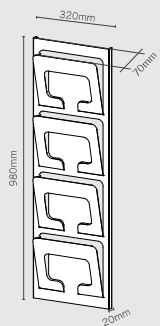

- metallo verniciato a polvere, superficie liscia, montatura verticale alla parete
system aus pulverbeschichtetem metall, glatte oberfläche, für vertikale befestigung an die wand
- system made of powder-coated metal, smooth surface, for vertical fixation on the wall
- colori disponibili:
porpora traffico, verde giallastro e bianco traffico
verfügbare trend-farben:
verkehrsipurpur, gelbgrün und verkehrsweiß
- available colours:
traffic purple, yellow green and traffic white
- sistema a quattro tasche
system aus vier taschen
four pockets system



scoop è montato alla parete in un batter d'occhio
scoop ist im handumdrehen an die wand befestigt
scoop can be fixed on the wall in the blink of an eye



A	SCOOP		
1	SCO4A4HMG	● scoop traffic purple, 1pc	
2	SCO4A4HGR	● scoop yellow green, 1pc	
3	SCO4A4WH	● scoop traffic white, 1pc	



2
scoop yellow green



calcolare le distanze, effettuare quattro fori nella parete (Ø 6mm), inserire viti e tasselli

abstände abmessen, vier löcher bohren (Ø 6mm) und dübel und schrauben einsetzen

measure the distances, drill 4 holes and insert dowels and screws



appendere il portariviste nei quattro angoli

den zeitungshalter an den vier ecken einhängen

hook the newspaper rack into the 4 screws



spingerlo lentamente verso il basso, finchè tutte le quattro viti scattano

langsam nach unten schieben, bis alle vier schrauben eingehakt sind

slide it downward slowly until all 4 screws are fully hooked into

advantages

- colori chic, carattere trendy, design elegante
schicke trendfarben und elegantes, zeitloses design
trendy colours, elegant design
- offre spazio a riviste e giornali di ogni tipo e misura
bietet platz für zeitungen und zeitschriften aller art und größen
provides enough space for newspapers and magazines of various formats and sizes
- facile da montare
ist leicht zu montieren
easy to mount
- materiale di alta qualità, robusto e durevole
das material ist hochwertig, robust und langlebig
premium-quality material, solid and long-lasting





magic board

MADE IN EU design by KD

IT tabella informativa, scaffale, portadepliant o lavagna magnetica? magic board è tutto questo e ancora di più! grazie ai molteplici accessori della linea prodotti magic le sarà possibile comporre una bacheca personalizzata per presentare ed informare con stile. grazie agli appositi fori potrà agganciare a magic board tasche portabrochure, display informativi e portaoggetti. magic board: un sistema modulare che offre infinite possibilità creative in ufficio e a casa.

DE infowand, regal, prospekthalter oder magnettafel? mit magic board müssen sie sich nicht entscheiden, denn das clevere modulsystem kann all das und noch viel mehr! durch die vielfältigen accessoiress der magic-line können sie sich ihr präsentations- und informationsboard genau so gestalten, wie sie es gerade brauchen. prospekttaschen, info-displays und objektblagen können mühelos in die fräsungen ein-, aus- und umgehängt werden. das modulsystem von magic board: unbegrenzte möglichkeiten für ihre kreativität im office- und homebereich.

EN information wall, shelf, display holder or magnet board? with magic board there is no need to choose one single solution! the clever modular system is an all-in-one solution and can do even more! thanks to the multifaceted accessories of the magic line you can build your personal presentation and information board! brochure pockets, information displays and object trays can be easily inserted, taken off and re-hung into the special cnc cuts. the magic board modular system: unlimited possibilities for your creativity in the office or at home.



magic board è magnetico! ordini in aggiunta al pannello i funzionali bottoni calamita

praktische magnetknöpfe einfach mitbestellen

magnetic panel: just include the handy magnets in your order



information

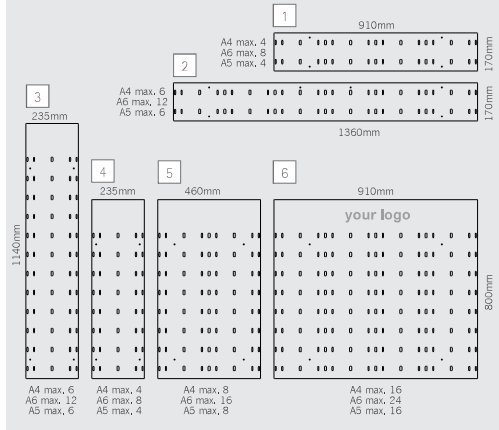

tasca portadepliant in policarbonato antiurto da agganciare all'espositore, resistente ai raggi UV, formati disponibili DIN A4, A5 e A6.
prospektschale zum einhängen, aus uv-resistentem, schlagfestem polycarbonat, für die formate DIN A4, A5 und A6.
brochure holder to hook on, uv- and shock-resistant polycarbonate, for the sizes DIN A4, A5 and A6

A	magic board	description	hxb
1	MBWH170910H	magic board	170x910mm, 1pc
2	MBWH1701360H	magic board	170x1360mm, 1pc
3	MBWH1140235V	magic board	1140x235mm, 1pc
4	MBWH800235V	magic board	800x235mm, 1pc
5	MBWH800460V	magic board	800x460mm, 1pc
6	MBWH800910H	magic board	800x910mm, 1pc
7	MZIPA6BRPC	brochure holder	A6, 1pc
8	MZIPA5BRPC	brochure holder	A5, 1pc
9	MZIP300BRPC	brochure holder	A4, 1pc
10	MZIP300EAL*	aluminium tray	1pc
11	MZIP300EPL*	acrylic tray	1pc
12	MZIP158SRB*	metal tray	1pc
13	MZIP158SRGG	acrylic glass tray	1pc
14	ACAL20CM	magnet chrome	ø20mm, 10pcs
15	ACAL16RS*	magnet red	ø16mm, 10pcs
16	ACAL40BL*	magnet blue	ø40mm, 10pcs
17	ACAL40RS*	magnet red	ø40mm, 10pcs

* fino ad esaurimento scorte | solange vorrat reicht | while stock last



information

metallo verniciato a polvere, bianco traffic opaco
pulverbeschichtetes metall, verkehrsweiß seidenmatt
powder coated metal, matt traffic white

ripiano leggermente inclinato in alluminio anodizzato color argento, compatibile con tutti gli espositori magic, DIN A4, bordo frontale alto 38mm.
ablage, leicht geneigt, silbermatt eloxiertes aluminium, kompatibel mit allen magic zips, DIN A4, frontaler rand 38mm.
tray, slightly sloped, silver anodized aluminium, matching with all magic zips, DIN A4, 38mm frontal edge.

ripiano leggermente inclinato in acrilico trasparente e antiurto, compatibile con tutti gli espositori magic, DIN A4, bordo frontale alto 38mm.
ablage, leicht geneigt, schlagfestes, transparentes acrylglas, kompatibel mit allen magic zips, DIN A4, frontaler rand 38mm.
tray, slightly sloped, shock-resistant transparent acrylic, matching with all magic zips, DIN A4, 38mm frontal edge.

ripiano in lamiera di metallo verniciato a polvere, 158mmx218mm (pxb).
ablage aus metall, silbermetallisch pulverbeschichtet, 158mmx218mm (txb).
metal tray, silvermetallic powder coated, 158mmx218mm (dxw).

ripiano in acrilico color vetro, agganci laterali in alluminio anodizzato color argento, 158mmx218mm (pxb).
ablage aus acrylglas glasgrün, seitliche halterungen silber eloxiertes aluminium, 158mmx218mm (txb).
acrylic glass tray, sideparts anodized aluminium, 158mmx218mm (dxw).



magic wall

MADE IN EU design by KD

IT ubicazione fissa ma configurazione variabile? magic wall è ciò che più le si addice! i pannelli di alluminio si fissano a parete in un batter d'occhio con il pratico set di montaggio; grazie agli accessori della linea magic potrà configurare magic wall come preferisce. facili da montare e smontare, sono disponibili porta-informazioni, porta-cataloghi o riviste, porta cd, lavagne magnetiche e scaffali portaoggetti in acrilico o in metallo – elegante completamento per l'ufficio o l'abitazione. sistema modulare magic wall: possibilità illimitate per la sua creatività.

DE der standort ist fix, aber die gestaltung soll flexibel bleiben? dann liegen sie mit magic wall genau richtig. mit dem beigelegten montageset paneele wandmontieren und mit den elementen der magic accessories gestalten, wie sie es brauchen. schnell ein- und ausgehängt entstehen infowände, prospekt- oder zeitschriftenständer, cd-regale oder produktpräsentier im office- und homebereich das modulsystem von magic wall: unbegrenzte möglichkeiten für ihre kreativität.

EN unlimited arrangements in one place is what you're looking for? with magic wall you are on the ball. wall mount the aluminium panel to the wall with the spacer kit supplied and design it freely with the manifold magic accessories to your hearts desire. quickly attached you get information panels, brochure or magazine racks, cd shelves, or product displays for office, showroom or home. the modular system magic wall: there is no limit to your creative powers.

information

pannello in alluminio anodizzato con fessure laterali per l'aggancio degli accessori della serie magic uno sotto l'altro, materiale per il montaggio incluso.

panel aus eloxiertem aluminium mit fassungen zum einhängen der magic zubehör elemente übereinander, inkl. montageset.

anodized aluminium panel with notches to attach the magic elements one upon the other, mounting kit included.

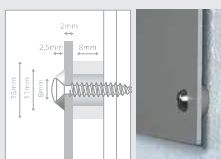
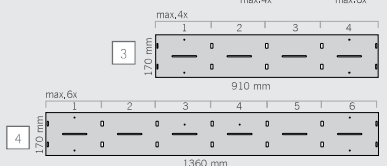
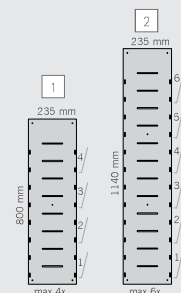

montaggio a muro con distanziali in materiale plastico e anellino di acciaio; kit completo di viti e tasselli

wandmontage mit distanzhaltern aus kunststoff, edelstahlring, komplettes kit mit schrauben und dübeln

wall mounted with plastic spacers, stainless steel ring, complete mounting kit with screws and dowels



A magic wall

description hxb

1	MW800235V*	magic wall 800x235mm, 1pc	
2	MW1140235V*	magic wall 1140x235mm, 1pc	
3	MW170910H*	magic wall 170x910mm, 1pc	
4	MW1701360H*	magic wall 170x1360mm, 1pc	

* fino ad esaurimento scorte | solange vorrat reicht | while stock last



pixquick magic A4 o A5 policarbonato trasparente con supporti laterali in alluminio anodizzato color argento

pixquick magic A4 o A5: transparentes polycarbonat, mit silber eloxierten aluminium halterungen

pixquick magic A4 o A5: transparent polycarbonate, with silver anodized aluminium supports



tasca portadepliant da agganciare sull'espositore, in policarbonato antiriflesso e resistente ai raggi UV, per formato DIN A4

prospektschale zum einhängen, aus uv-resistentem, schlagfestem polycarbonat, für DIN A4 format

brochure holder to hook on, uv- and shock-resistant polycarbonate, for DIN A4 size



magic divider in acrilico trasparente, divide inserendolo la tasca A4 (MZIP300BRPC) in 2 scomparti A6.

magic divider transparentes acrylglas, unterteilt durch ein Schub die prospekttasche A4 (MZIP300BRPC) in 2 A6 fächer.

magic divider transparent acrylic, put into the A4 brochure tray MZIP300BRPC and get a place for 2 A6



ripiano in lamiera di metallo verniciato a polvere, 158mmx218mm (pxb)

ablage aus metall, silbermetallisch pulverbeschichtet, 158mmx218mm (txb)

metal tray, silvermetallic powder coated, 158mmx218mm (dwx)



ripiano in acrilico color vetro, agganci laterali in alluminio anodizzato color argento, 158mmx218mm (pxb)

ablage aus acrylglas glasgrün, seitliche halterungen silber eloxiertes aluminium, 158mmx218mm (txb)

acrylic glass tray, sideparts anodized aluminium, 158mmx218mm (dwx)



porta CD in metallo verniciato a polvere per 15 CD, 125mmx225mm (pxb)

CD-halter für 15 cd, metall silbermetallisch pulverbeschichtet, 125mmx225mm (txb)

rack for 15 cd, silvermetallic powder coated, 125mmx225mm (dwx)



sostegno in metallo verniciato a polvere per esporre in modo ben visibile fino a 6 giornali s/o riviste, 720mmx260mmx90mm (hx bxp)

zeitschriftenhalter mit 6 körben übereinander, metall silbermetallisch pulverbeschichtet, 720mmx260mmx90mm (hx bxt)

magazin rack with 6 baskets one upon the other, silvermetallic powder coated, 720mmx260mmx90mm (hx bxd)



A magic accessories

1	PQMA5*	pixquick magic A5, 1pc	
2	PQMA4	pixquick magic A4, 1pc	
3	MZIP300BRPC	brochure tray A4, 1pc	
4	MDIV02	magic divider, set 2pcs	
5	MZIP158SRB*	metal tray, 1pc	
6	MZIP158SRGG	acrylic glass tray, 1pc	
7	MZIP15CRFI*	CD-rack, 1pc	
8	MZIP6PRFI	magazin rack, 1pc	

* fino ad esaurimento scorte | solange vorrat reicht | while stock last



3 rail 1500mm



profilo in alluminio anodizzato, materiale per il montaggio incluso.

eloxiertes aluminiumprofil, komplett mit montageset.

anodized aluminium rail, including mounting kit.



contenitori da appendere in formato DIN A4, DIN A5 o DIN A6, in polistirolo.

box zum einhängen für DIN A4, DIN A5 oder DIN A6 format, aus ps-polystirol.

container attachable for DIN A4, DIN A5 or DIN A6 format, made of polystyrene.

information

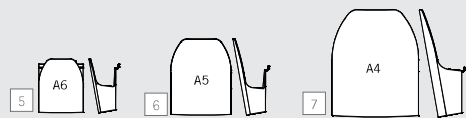

dacapo

MADE IN EU design by KD

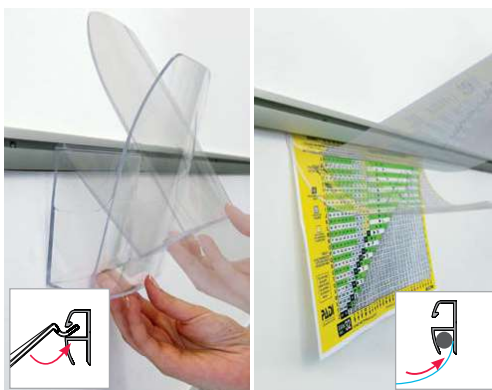

IT binario dacapo in alluminio anodizzato color argento a due funzioni: profilo per agganciare tasche portadocumenti in formato A4, A5 e A6 o binario per inserire fogli singoli, disegni, offerte, progetti e appunti rimangono visibili al loro posto grazie alla speciale struttura di dacapo. basta piegare i fogli verso l'alto e tirarli anche verso l'esterno per estrarli dal binario. le tasche portadocumenti in materiale plastico trasparente stampato ad iniezione si inseriscono e si spostano facilmente sul binario.

DE die dacapo schiene aus silber eloxiertem aluminium hat gleich doppelten nutzen: einmal als einhänge-schiene für die prospekttaschen in A4, A5 oder A6 und zugleich als halter für einzelblätter, notizen, zeichnungen, angebote, pläne werden einfach von unten eingeschoben, das dacapo rail hält durch die raffinierte konstruktion. zum herausnehmen die blätter einfach nach oben biegen und herausziehen. die taschen aus transparentem kunststoff-druckguss für prospekte einfach wie gewünscht ein-, um- und aushängen.

EN dacapo rail in silver anodised aluminium is multi use: it can be a profile to hold A4, A5 or A6 sized brochure holders, or, a rail where you can insert and hold single sheets, notes, designs, quotes, projects, all stay in their place and on view, thanks to the refined design of dacapo. to remove a sheet of paper simply fold it upwards and at the same time gently pull. the brochure holders, made of die-cast transparent plastic, are easily inserted or moved along the rail.

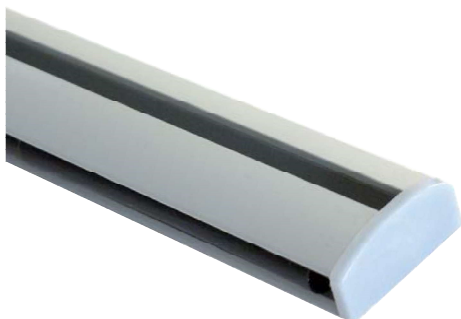

7 container for A4

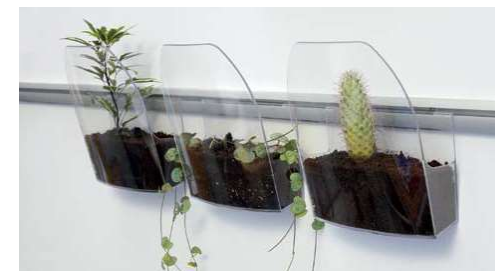

A dacapo

1	DCR500	dacapo rail 500mm, 1pc
2	DCR1000	dacapo rail 1000mm, 1 pc
3	DCR1500	dacapo rail 1500mm, 1pc
4	DCR2000	dacapo rail 2000mm, 1pc
5	DCTA6	container A6, 1pc
6	DCTA5	container A5, 1pc
7	DCTA4	container A4, 1pc





2
dacapo maxi 1000mm

dacapo maxi

MADE IN EU quality control by KD



IT dacapo maxi, per una comunicazione semplice, veloce e creativa! il binario in alluminio anodizzato color argento è il profilo perfetto per fogli singoli di ogni formato. l'intelligente sistema di sospensione, disponibile in diverse lunghezze, viene fissato a parete, dacapo maxi è concepito per una comunicazione dinamica e in continuo cambiamento che necessita di un supporto flessibile e facile da utilizzare. fogli singoli, anche e soprattutto di grande formato, possono essere facilmente inseriti nel binario, il nostro consiglio: perfetto per sale congressi e aule, consente di esporre uno accanto all'altro i fogli delle flipcharts, garantendo una maggiore visibilità per i relatori e anche per chi partecipa a seminari e corsi! dacapo maxi è anche il sistema ideale per la presentazione di piantine e progetti di architetti, uffici tecnici e designer, come anche per l'illustrazione di immagini e informazioni in asili, scuole e centri di formazione.

DE dacapo maxi, ihre einfache, schnelle und kreative kommunikation! die schiene aus silber eloxiertem aluminium ist der perfekte präsentier für poster, karten, zeichnungen oder bilder in papierform. das clevere befestigungssystem ist in verschiedenen längen erhältlich. dacapo maxi eignet sich insbesondere für häufig wechselnde information auch grosser formate aus papier. unser tipp: perfekt für seminar- und schulungsräume - flipchart-papers werden einfach nebeneinander präsentiert, mehr übersicht für seminarleiter wie teilnehmer! dacapo maxi ist aber auch optimal für die präsentation von grossen grundrissen und plänen von architekten, technischen büros und designern geeignet sowie zur illustrationen von bildern und informationen in kindergärten, schulen und weiterbildungseinrichtungen.

EN dacapo maxi, the simple, quick and trendy communication for you! the rail made of silver anodized aluminium is the perfect display for posters, maps, drawings or pictures made of paper. the clever mounting system is available in different lengths. dacapo maxi is ideal for frequently changing information made of paper, also in big sizes! our tip: equip training classrooms or seminar rooms - flip chart papers can be simply displayed side by side, more clear view for trainers and attendees as well! besides this dacapo maxi is well suited for the presentation of big footprints and architect's plans, technical offices and designers as well as for the illustration of images and information in kindergartens, schools and further education facilities.



appunti, disegni, offerte e progetti possono essere facilmente inseriti nel binario introducendoli dal basso verso l'alto

dacapo maxi hält notizen, zeichnungen, angebote und pläne durch das leichte und sichere klemmsystem.

notes, designs and projects stay in their place thanks to the light and secure dacapo maxi clamping system

A dacapo maxi

1	DCM500	dacapo maxi rail 500mm, 1pc	
2	DCM1000	dacapo maxi rail 1000mm, 1pc	
3	DCM2000	dacapo maxi rail 2000mm, 1pc	



3
dacapo maxi 2000mm

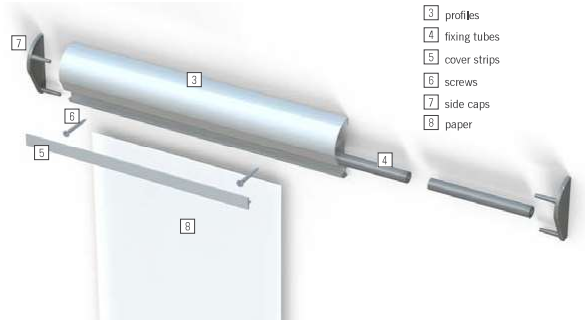

- advantages**
- ✓ cambio di informazioni veloce
schneller informationswechsel
fast communication exchange
 - ✓ perfetto per fogli singoli di ogni formato
hält alle einzelblätter in unterschiedlichen formaten
holds single sheets of each format
 - ✓ sistema ad incastro con viti nascoste
ausgeklügeltes montagesystem mit abgedeckten schrauben
cleverly devised mounting system with covered screws
 - ✓ ideale per aule e studi di architetti e designer
perfekt für schulungsräume, architektur- und design studios
perfect for training classrooms or architects & designer studios

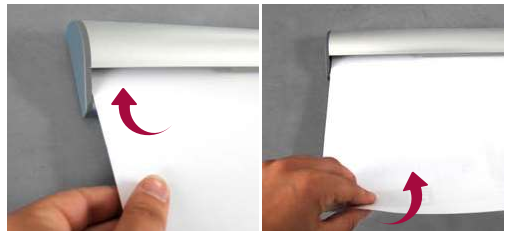

inserire i fogli singoli dal basso
einzelblätter einfach von unten einschieben
single sheets can simply be inserted from underneath

per estrarre i fogli basterà semplicemente sollevarli
zum herausnehmen die blätter einfach nach oben herausziehen
to remove the paper simply lift it up and pull gently upwards

information

profilo in alluminio anodizzato, materiale per il montaggio incluso.

material: silber eloxiertes aluminium komplett mit montageset

silver anodized aluminium, including mounting kit





ripiano

MADE IN EU design by KD



montaggio semplice e senza utensili: il peso stesso e il listello di pvc all'interno del profilo mantengono i ripiani stabilmente in posizione.

einfach einhängen ohne werkzeug: eigen-gewicht und innenliegende pvc-schütz-litze halten fachböden in position

easily attached without any tools: the shelf's own weight and pvc protection lace keeps them in a stable position

IT design nobile adatto a qualsiasi tipo di arredamento per negozi, uffici, hotel o per casa: montare a parete il binario e agganciare semplicemente il ripiano in vetro. la particolare sfaccettatura degli angoli molati crea bellissimi effetti di luce. anche in combinazione con scaffali di altri materiali, ripiano è semplicemente splendido.

DE edles design für jede einrichtung ob shop, office, hotel oder home: ripiano rail wandmontieren und die glasfachböden einfach eingehängen. der besondere kantenschliff schafft brillante lichteffekte. aber auch mit ablagen aus anderen materialien sieht ripiano einfach toll aus.

EN noble design for every ambience in shops, offices, hotels or homes: wall mount the ripiano rail and simply attach the tempered glass shelves. the special design of the glass edges creates brilliant light effects. also with shelves in other materials ripiano is a real looker.



2 + 5
rail 600 + glass
600x240mm

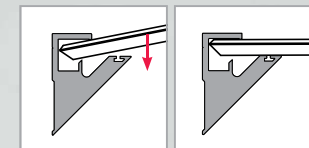

profilo in alluminio anodizzato color argento, materiale per il montaggio incluso

silber eloxiertes aluminium profil, inkl. montagematerial

silver anodized aluminium profile, incl. mounting material

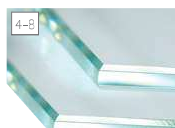

vetro temperato di sicurezza, con angoli molati, logo in serigrafia

temperiertes sicherheitsglas mit facetenschliff, siebdruck logo

tempered glass with faceted edges, silk screen printed brand



pratici tappi laterali per i suoi profili ripiano: set con due tappi in colore grigio chiaro

praktische abdeckkappen für ihre ripiano rails: set mit zwei endkappen aus lichtgrauem kunststoff

convenient covering caps for your ripiano rails: set with two end caps made of light grey synthetics printed brand

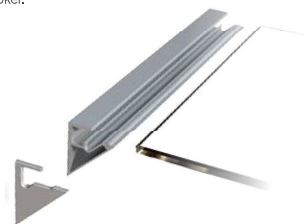

A ripiano

1	RIR400AL	rail 400mm, 1pc	
2	RIR600AL	rail 600mm, 1pc	
3	RIR900AL	rail 900mm, 1pc	
4	RIV400240	glass 400x240mm, 1pc	
5	RIV600240	glass 600x240mm, 1pc	
6	RIV600320	glass 600x320mm, 1pc	
7	RIV900240	glass 900x240mm, 1pc	
8	RIV900320	glass 900x320mm, 1pc	
9	RIAKLG	ripiano covering caps, set 2pcs	

altezza x larghezza | höhe x breite | height x width

information

il nostro consiglio: provi ripiano anche in combinazione con scaffali in altri materiali come legno o pietra.

unsere tip: probieren sie ripiano in gleicher abmessung aber mit anderen materialien wie holz oder stein.

our tip: try ripiano in same size but with other materials such as wood or stone.

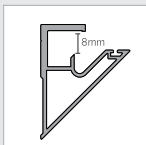

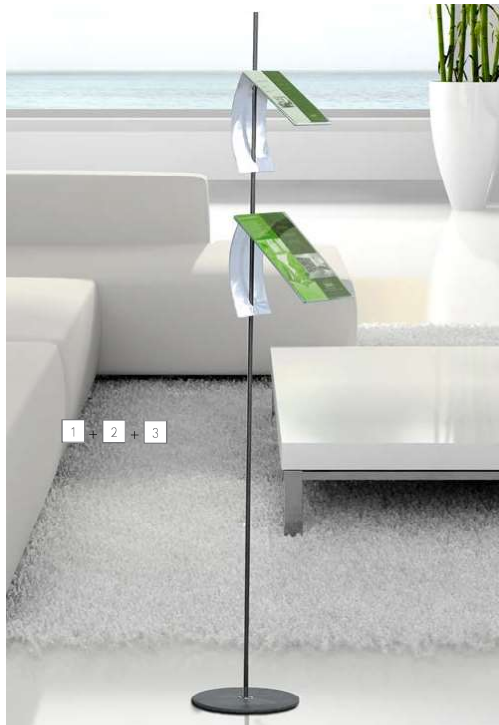

tasca porta informazioni realizzata in PETG, formato DIN A4, DIN A5 o DIN A6.

einschubtasche aus PETG, DIN A4, DIN A5 oder DIN A6.

poster pocket made of PETG, DIN A4, DIN A5 or DIN A6.



tasca portadeppliant realizzata in PETG, formato DIN A4 o DIN A5.

prospekttasche aus PETG, für DIN A5 oder DIN A4

brochure tray made of PETG, DIN A4 or DIN A5

information

struttura a stelo in metallo, verniciata a polvere in nero, altezza 1200mm, base Ø 195mm

basistruktur aus metall, schwarz pulverlackbeschichtet, höhe 1200mm, basis Ø 195mm

base structure made of metal, black powder coating, height 1200mm, base Ø 195mm

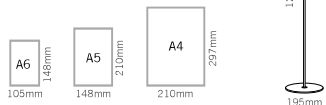

liftboy

MADE IN EU design by KD patented

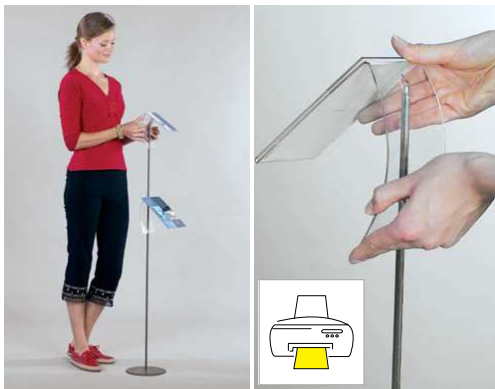

IT l'idea è geniale e protetta a livello internazionale: sulla struttura a stelo si inseriscono portainformazioni nei formati più comuni. l'altezza e la disposizione sono a libera scelta: il segreto sta tutto nell'elasticità del materiale con cui sono realizzati. scegli i portainformazioni o i porta cataloghi che preferisce e li componga sull'espositore nel modo che più ti aggrada. LIFTBOY – il display per informazioni intelligente adatto anche ad eleganti indicazioni di prezzi e a veloci informazioni sul prodotto.

DE die idee ist genial und – international geschützt: auf die grundstruktur mit stab schieben sie infohalter einfach auf. höhe und ausrichtung der einzelnen halter stellen sie frei ein, möglich durch die nutzung der spannkkräfte des elastischen materials. wählen sie posterhalter oder prospektaschen im gewünschten format und kombinieren sie beliebig. LIFTBOY - das smarte infodisplay für stilvolle preis- auszeichnung und schnelle produktinformation.

EN the idea is simple - and internationally protected: just put the trays on the bar, arrange level and direction of every single tray according to your needs thanks to the resilience of the elastic material. trays are available in common sizes. choose poster pockets or brochure trays in different sizes and combine freely. liftboy – the smart information display for stylish price tagging and elegant product information.



A liftboy

1	LB1200195GR	liftboy base structure, 1pc	
2	LBA6	liftboy poster pocket A6, 1pc	
3	LBA5	liftboy poster pocket A5, 1pc	
4	LBA4	liftboy poster pocket A4, 1pc	
5	LBPPA5*	liftboy brochure tray A5, 1pc	
6	LBPPA4*	liftboy brochure tray A4, 1pc	

* fino ad esaurimento scorte | solange vorrat reicht | while stock last

swift

MADE IN EU design by KD



2 swift pixquick A4



IT swift è un espositore da terra autoportante composto da un'asta telescopica, una base rotonda e un pixquick A4 o A5, che le permette di esporre in modo elegante fogli singoli senza cornici laterali e a prova di polvere. il cambio delle informazioni è semplice e veloce: basta aprire o staccare il pannello frontale. il design intelligente permette di variare il formato da orizzontale a verticale.

DE swift kombiniert pixquick A4 oder A5 als freistehendes bodensdisplay mit teleskopstange und runder basis, staubsicher und ohne rahmen einzelblattinfo elegant präsentieren, austausch jederzeit durch aufklappen oder abnehmen des frontpanels. das clevere design erlaubt schnelles wechseln von horizontal auf vertikal.

EN swift combines pixquick A4 or A5 as a freestanding floor display with telescopic bar and round base, a dust proof and elegant presentation of single sheet information without a visible frame, exchange anytime by opening or taking away the front cover. the clever design allows quick rotation from horizontal to vertical.

information

struttura di base formata da asta telescopica in alluminio anodizzato e base verniciata color argento metallizzato

basisstruktur, mit teleskopstange und halter, silber eloxiertes aluminium, basis silbermetall lackiert

base structure, telescopic bar and support made of silver anodized aluminium, silver metal coated base

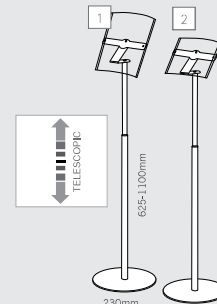

design and print with your own workstation

A swift

1	PQSWA5	swift pixquick A5, 1pc	
2	PQSWA4	swift pixquick A4, 1pc	



2
set flippy & stopquick

flippy

MADE IN EU design by KD

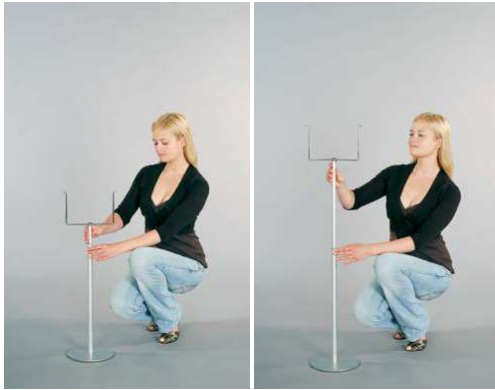

IT flippy, con asta telescopica e base verniciata in argento metallizzato, è un pratico display da terra autoportante. offriamo flippy in 4 differenti varianti sia come portainformazioni che come portacataloghi, tutti i supporti sono realizzati in acrilico color vetro di alta qualità, mentre il sostegno ad U è in ottone cromato. Il montaggio è semplicissimo: basta avvitare la base all'asta telescopica, scegliere l'altezza e il supporto desiderati e inserire l'informazione prescelta. In un batter d'occhio flippy è al lavoro, come indicatore di direzione, porta cataloghi o espositore pubblicitario.

DE flippy mit der teleskopstange aus aluminium und der silberlackierten basis ist ein praktisches freistehendes bodendisplay. wir bieten flippy in vier verschiedenen varianten für informations- und prospektpräsentation, alle träger sind aus hochwertigem, glasgrünem acrylglas, der u-halter aus verchromtem messing. basis anschrauben, die gewünschte höhe der teleskopstange einstellen und mit der passenden info bestücken. schon ist flippy im einsatz als ihr wegweiser, prospektständer oder infopräsentier.

EN flippy with its telescopic bar made of anodized aluminium and the silver coated base is a convenient free standing floor display. we offer flippy in four different versions for information or brochure presentation. all supports are made of high grade, glassgreen acrylic, the u-holder is made of chrome-plated brass. screw on the base, set up the telescopic bar to the required height and fill with your information. and here you go with your flippy as guidepost, brochure holder or information display.

information

espositore da terra, sostegno ad U in cromo lucido, asta telescopica in alluminio anodizzato color argento, base verniciata color argento metallizzato.

bodendisplay, u-haltebügel verchromt, teleskopstange silber eloxiertes aluminium, basis silbermetallisch lackiert.

floor display, u-support chrome-plated, telescopic bar silver anodized aluminium, base metallic silver coated.

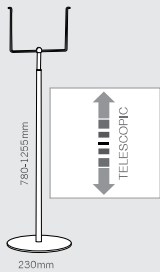

economic alu

A flippy set

1	FPY1STFGL	set flippy & stopfix, 1pc	
2	FPYSSTQ	set flippy & stopquick, 1pc	
3	FPYSSTU	set flippy & stopup, 1pc	
4	FPYSSTB	set flippy & stopbag, 1pc	



1
set flippy & stopfix



espositore flippy con pannello stopfix in acrilico color vetro, DIN A4, per stampa o prespaziati.

display flippy mit paneel stopfix, acryl glasgrün, DIN A4, zum bedrucken oder aufkaschieren.

display flippy with stopfix panel in glassgreen acrylic, DIN A4, for print or laminating.



3
set flippy & stopup



espositore flippy con portaposter stopup in acrilico color vetro, DIN A4, inclinato di 45°, inserimento del foglio laterale.

display flippy mit postertasche stopup, acryl glasgrün, DIN A4, 45° neigung, seitlicher einschub.

display flippy with glassgreen acrylic poster pocket stopup, DIN A4, 45° inclined, lateral sheet insertion.



2
set flippy & stopquick



espositore flippy con portaposter stopquick, acrilico color vetro, DIN A4, bifacciale, cambio velocco grazie alla chiusura con calamita.

display flippy mit postertasche stopquick, acryl glasgrün, DIN A4, beidseitig, einfacher austausch dank magnetverschluss.

display flippy with glassgreen acrylic poster pocket stopquick, DIN A4, double side, easy exchange thanks to the magnetic lock.



4
set flippy & stopbag



espositore flippy con tasca portadeppliant stopbag in acrilico color vetro, DIN A4, inclinata di circa 30°, adatta per circa 200 fogli singoli.

display flippy mit prospekttasche stopbag, glasgrünes acryl, DIN A4 format, 30° neigung, für ca. 200 einzelblattprospekte.

display flippy with glassgreen acrylic brochure pocket stopbag, thickness 3mm for DIN A4 format, inclined 30°, for approx. 200 single sheet brochures



smart menu

MADE IN EU design by KD

IT smart menu mostra l'informazione sia in orizzontale che in verticale facilitando la lettura grazie all'inclinazione a 45°. la tasca portainformazioni, trasparente e priva di cornici, è semplice da aprire e facilita il cambio. il punto forte di smart menu: può cambiare l'orientamento della tasca in modo autonomo. la soluzione perfetta per l'esposizione di menu, indicazioni direzionali di segnaletica, orari di apertura, informazioni a breve termine e messaggi pubblicitari di ogni tipo.

DE smart menu zeigt ihre einzelblatt-info horizontal oder vertikal in einem Leserfreundlichen 45° winkel. die rahmenlose, transparente postertasche lässt sich ganz leicht öffnen und ermöglicht schnellen zugriff für den info-tausch. der clou bei smart menu: sie können das format von horizontal auf vertikal selbst umstellen. dieser smarte aufsteller präsentiert gerne menü-karten, wegweiser, öffnungszeiten, kurzfristige info oder werbung aller art.

EN smart menu displays your information horizontally or vertically in a reader-friendly 45° angle. the frameless, transparent poster pocket can be opened easily and allows quick exchange. smart menu's special: you can adjust the format from horizontal to vertical just by yourself. this smart display presents menus, works as a signpost, shows opening hours, short-term information or publicity of all kinds.

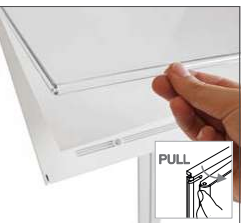
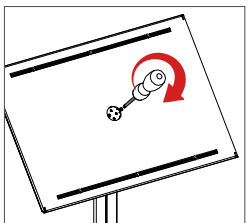

per il cambio da orizzontale a verticale (o viceversa) allentare le viti e fissarle di nuovo dopo aver modificato l'orientamento.
 für die umstellung von horizontal auf vertikal (und umgekehrt) einfach die schrauben lösen und in der neuen position wieder fixieren.
 to change from horizontal to vertical (and vice versa) simply loose the screws and fix again in the new position.

la tasca può essere aperta completamente o solo lateralmente
 poster tasche kann seitlich oder komplett geöffnet werden
 poster pocket can be opened on one side or completely

information

tasche portainformazioni in policarbonato trasparente stampato ad iniezione, retro in abs bianco con copertura in alluminio anodizzato color argento, profilo portante in alluminio anodizzato color argento, base di metallo con copertura in materiale plastico

postertaschen aus transparentem polycarbonat spritzguss, rückseite weisses ABS mit silber eloxierter alu-blende, silbermatt eloxiertes alu-strangprofil, metall-basis mit kunststoff-abdeckung

poster pockets made of transparent polycarbonate die-cast, rear side white ABS with silver anodized aluminium cover, silver matt anodized aluminium extrusion, metal base with synthetic cover

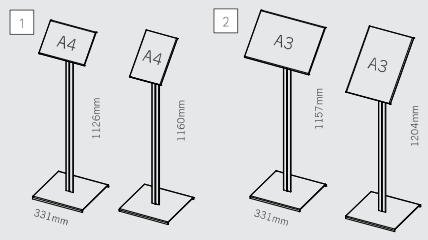

A	smart menu	
1	SMMA4	smart menu A4, 1pc
2	SMMA3	smart menu A3, 1pc



2 smart menu A3

advantages

- ✓ lettura facilitata grazie a inclinazione 45°
 leser-freundlicher 45° winkel
 reader-friendly 45° angle
- ✓ presentazione pulita e priva di cornici
 rahmenlose, saubere präsentation
 frameless, neat presentation
- ✓ policarbonato di alta qualità, resistente e stampato ad iniezione
 hochwertiger resistenter polycarbonat spritzguss
 high-grade resistant polycarbonate die-cast
- ✓ flessibile nel formato e nell'orientamento
 flexibel bei format und ausrichtung
 flexible in format and arrangement



layout realizzabile e stampabile con un semplice pc
 layout am eigenen pc gestalten und ausdrucken
 design and print with your own workstation





smart floor

MADE IN EU design by KD

IT smart floor è la soluzione perfetta ovunque sia necessario cambiare fogli informativi in modo frequente. Le tasche portainformazioni con look senza cornice possono essere posizionate all'altezza desiderata e fissate direttamente al profilo con le viti filettate. Le tasche possono essere aperte lateralmente o completamente. In questo modo il cambio è semplice e veloce. La presentazione senza effetto cornice, le tasche piatte e il design snello mettono al centro la cosa più importante: la sua informazione!

DE der smart floor empfiehlt sich für häufig wechselnde einzelblatt-info, die rahmenlosen postertaschen werden in der gewünschten höhe platziert und dann mit den gewindschneidenden schrauben einfach direkt am profil befestigt. die postertaschen lassen sich ganz oder seitlich öffnen, damit ist der austausch leicht und schnell, die rahmenlose präsentation, die flache tasche und das schlanke design, stellen das in den vordergrund worauf es ankommt: ihre information!

EN smart floor is best for often exchange information, the frameless poster pockets are placed at the needed height and then simply mounted directly to the profile with the thread cutting screws. the poster pockets open on the side or completely, thus the information exchange is easy and quick, the frameless presentation, the flat pocket and the lean design put forward what really counts: your information!

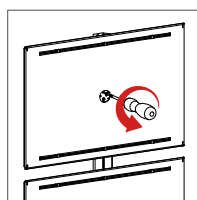

posizionare le tasche sul retro e fissarle con le viti filettate

taschen auf der rückseite positionieren und mit gewindschneidender schraube befestigen

place poster pockets and needed height and mount with the thread cutting screws

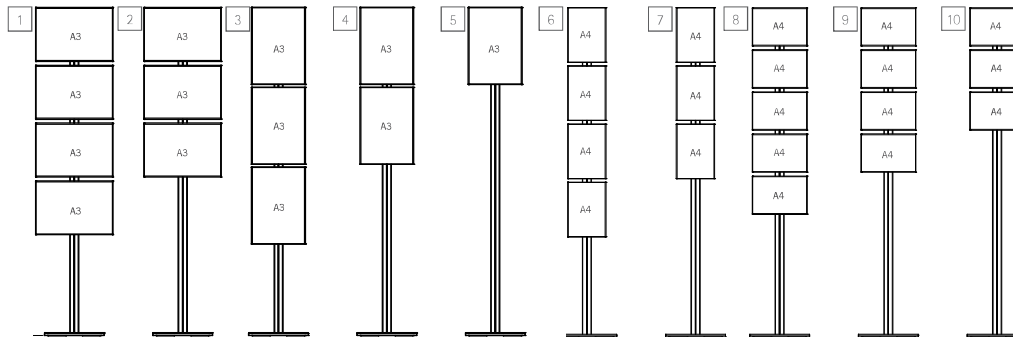

altre composizioni su richiesta | weitere kompositionen auf anfrage | other composition on request



advantages

- look senza cornice e protezione dalla polvere
rahmenlos und staubgeschützt
frameless and dust-protected
- policarbonato resistente stampato ad iniezione
resistenter polycarbonat spritzguss
resistant polycarbonate die-cast
- flessibilità di configurazione e nel posizionamento tasche
flexibel bei taschen-position und -konfiguration
flexible for pocket position and configuration
- estendibile a versione bifacciale
doppelseitig erweiterbar
double-side upgradeable

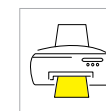

layout realizzabile e stampabile con un semplice pc
layout am eigenen pc gestalten und ausdrucken
design and print with your own workstation

information

tasche portainformazioni in policarbonato trasparente stampato ad iniezione, retro in abs bianco con copertura in alluminio anodizzato color argento, profilo portante in alluminio anodizzato color argento, base di metallo con copertura in materiale plastico

postertaschen aus transparentem polycarbonat spritzguss, rückseite weisses abs mit silber eloxierter alu-blende, silbermatt eloxiertes alu-strangprofil, metall-basis mit kunststoff-abdeckung

poster pockets made of transparent polycarbonate die-cast, rear side white abs with silver anodized aluminium cover, silver matt anodized aluminium extrusion, metal base with synthetic cover

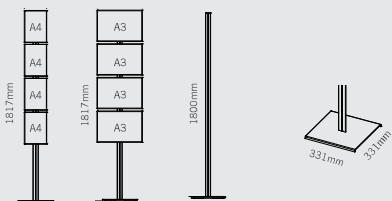

A smart floor

1	SMF4A3H	smart floor 4xA3 horizontal, 1 pc
2	SMF3A3H	smart floor 3x A3 horizontal, 1 pc
3	SMF3A3V	smart floor 3x A3 vertikala, 1 pc
4	SMF2A3V	smart floor 2x A3 vertikala, 1 pc
5	SMFA3V	smart floor A3 vertikala, 1 pc
6	SMF4A4V	smart floor 4x A4 vertikala, 1 pc
7	SMF3A4V	smart floor 3x A4 vertikala, 1 pc
8	SMF5A4H	smart floor 5x A4 horizontal, 1 pc
9	SMF4A4H	smart floor 4x A4 horizontal, 1 pc
10	SMF3A4H	smart floor 3x A4 horizontal, 1 pc
11	SMFSQA4WH	single smartquick A4, 1 pc
12	SMFSQA3WH	single smartquick A3, 1 pc
13	MGFS1800	single profile 1800mm, 1 pc

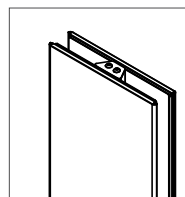

estensione bifacciale: ordini le tasche aggiuntive nei formati che preferisce, esse verranno poi fissate alla scanalatura sul retro del profilo con le viti filettate all'altezza desiderata

doppelseitige erweiterung: einfach zusätzliche taschen im gewünschten format dazubestellen, die taschen werden dann mit den gewindschneidenden schrauben auf der rückseitigen nut des profils in entsprechender höhe angebracht

double-side upgrade: simply order additional pockets in the needed format, the pockets are then mounted to the rear nut of the profile with the thread cutting screws.



glass mag

MADE IN EU design by KD

IT glass mag è una soluzione resa moderna e trendy dalla combinazione di vetro e metallo. le tasche sono premontate sul retro del vetro e dotate di un sistema di chiusura magnetico, il cambio veloce delle informazioni è garantito e la stampa ben protetta dietro il vetro temperato, quest'ultimo può essere personalizzato tramite stampa. glass mag è molto stabile grazie alla base in metallo verniciato a polvere color antracite, il passepartout per l'informazione è grigio argento, glass mag è disponibile in diverse misure e in diverse configurazioni.

DE glass mag ist modern und trendy durch die kombination von glas und metall. die infotaschen werden rückseitig vormontiert und haben einen magnetverschluss, der einfache und schnelle info-tausch ist damit garantiert und ihre information ist gut geschützt hinter glas. sie können das temperierte glas auch mit druck personalisieren. glass mag steht sicher auf seiner anthrazit pulverlackbeschichteten metall-basis, das passepartout für die info ist silbergrau, wir bieten den glass mag in verschiedenen grössen und konfigurationen an.

EN glass mag combines in a modern and trendy way glass and metal. the poster pockets with magnetic fastener are already mounted on the rear side of the glass. you can customize the tempered glass also with print. glass mag stands safely on its anthracite powder coated metal base, the passe-partout for your information is silver grey. we provide you with glass mag in different sizes and configurations.



cambio veloce grazie alla tasca con chiusura magnetica

schnell getauscht dank magnetischer postertasche, saubere präsentation hinter glass

quickly exchanged thanks to the magnetic poster pocket, clean presentation behind glass

other possible combinations on request



A glass mag

description hxb

	1	2	3	4	5	6	7	8
	GMG1400355A4H	GMG14003552A4H	GMG1400355A4V	GMG1400355A3V	GMG17004253A4H	GMG17004252A4H	GMG17004252A4V	GMG1700425A3V
	glass mag 1400x355mm A4 horizontal	glass mag 1400x355mm 2xA4 horizontal	glass mag 1400x355mm A4 vertikál	glass mag 1400x355mm A3 vertikál	glass mag 1700x425mm 3xA4 horizontal	glass mag 1700x425mm 2xA4 horizontal	glass mag 1700x425mm 2xA4 vertikál	glass mag 1700x425mm A3 vertikál

information

vetro temperato, base in metallo verniciato a polvere, tasche portainformazioni con chiusura magnetica

temperiertes glas, pulverlackbeschichtete metall-basis, postertasche mit magnetverschluss

tempered glass, powder coated metal base, poster pocket with magnet

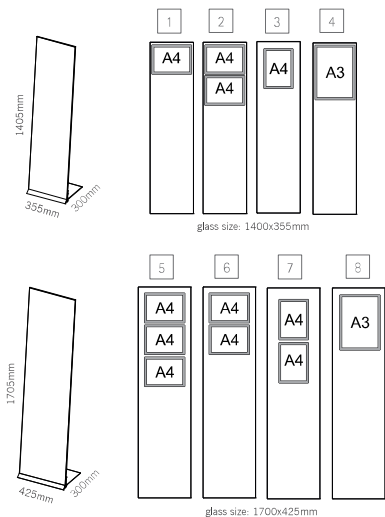

advantages

- ✓ esposizione dell'informazione pulita e dietro vetro
information liegt sauber hinter glass
information is presented neat and clean behind glass
- ✓ elegante combinazione di vetro e metallo
elegante kombi aus metall und glas
elegant combination in metal and glass
- ✓ cambio veloce grazie alla chiusura magnetica delle tasche
schneller tausch durch magnetverschluss
quick exchange thanks to magnetic poster pocket
- ✓ look leggero e trasparente
leichte, transparente anmutung
lean, transparent look-and-feel



print not included

information

pannello in alluminio composito bifacciale, bianco opaco e argento metallico, base in mdf laccata color argento, cavo di acciaio con chiusura automatica di sicurezza.

doppelseitig verwendbares alu-verbundpaneel in matt-weiss und silber, silber lackierte mdf basis, stahlseil mit matic-verschluss.

double-sided aluminium-composite panel matt white and silver, silver varnished base made of mdf, steel cable with matic lock.

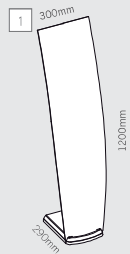

velo shark

MADE IN EU design by KD

IT grazie all'espositore velo shark le sue presentazioni assumeranno un altro mordente: il pannello in alluminio composito può essere completato liberamente e a scelta con i porta informazioni pixquick, nei diversi formati disponibili. Il pannello è anche bifacciale: un lato è in decorativo argento metallico, l'altro è bianco opaco. Il nostro consiglio: personalizzi il suo velo shark con una stampa digitale diretta sul lato bianco opaco, adatto a questo uso.

DE mit velo shark bekommt ihre info-präsentation richtig biss: das alu-verbund-paneel kann von ihnen frei mit pixquick info-präsentern in verschiedenen formaten gestaltet werden. das alu-verbund-paneel ist doppelseitig: dekorativ metallic silber bzw. matt weiss. unser tip: personalisieren sie ihren velo shark auf der weissen seite mit digitalem direktdruck.

EN with velo shark your information presentation will have teeth: the aluminium composite panel can be personalised easily with our pixquick information displays in different formats. the composite panel is double-sided: decorative metallic silver or matt white. our tip: the white side is perfect for customization with direct digital print.



print not included



print not included

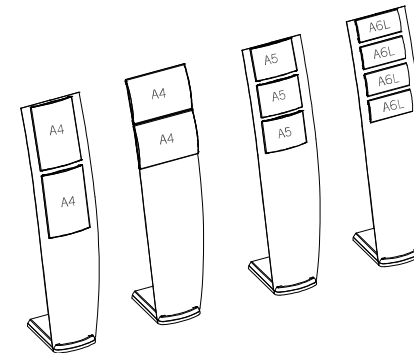

porta informazioni in policarbonato trasparente stampato ad iniezione, biadesivo incluso.

postertasche aus transparentem polycarbonat spritzguss, incl. doppelkleber.

poster pocket made of transparent polycarbonate die-cast, incl. double sided adhesive tape.



A velo shark

1	VELOSH1200CO	velo shark, 1pc	
2	PQA6L	pixquick A6L, without support, 1pc	
3	PQA6	pixquick A6, without support, 1pc	
4	PQA5	pixquick A5 support included, 1pc	
5	PQA4	pixquick A4 support included, 1pc	
6	PQA3	pixquick A3, without support, 1pc	



bag soistes

MADE IN EU design by KD

IT la soluzione per tutto quanto possa o debba essere appeso: da sacchetti promozionali, lanyards, fino alle cuffie o alle catenelle... con bag andrà sul sicuro. l'altezza dei 2 è regolabile in altezza sul profilo. il pixquick bifacciale all'apice della struttura permette di personalizzare bag con una stampa in modo semplice e veloce.

DE ihr stummer diener für alles mit aufhänger: ob tragetaschen, lanyards, kopfhörer, ketten... mit bag sind sie gut beraten. die display bars können ganz nach bedarf in der höhe stufenlos verstellt werden, der doppelseitige pixquick posterhalter on top ermöglicht ihnen schnelle und einfache personalisierung mit print.

EN the ideal solution for everything that has to be suspended: from promotional bags, lanyards, head phones, cards, chains... you are sure with bag, the height of the display bars is freely adjustable. the double sided pixquick information pocket on the apex of the structure gives you the possibility to easily and quickly personalise bag with prints.

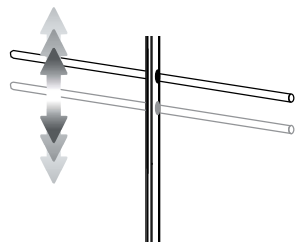

l'altezza dei 2 tubi regolabile in altezza sul profilo.

die display bars können ganz nach bedarf in der höhe stufenlos verstellt werden.

the height of the display bars is freely adjustable.

information

struttura in alluminio anodizzato argento con portainformazioni bifacciale in formato A4 realizzata con pixquick in polycarbonato stampato ad iniezione. base con protezione in abs colore cromo opaco.

doppelseitige einzelblattpräsentation pixquick format A4 aus polycarbonat-spritzguss, eloxiertes aluminium in silber, trittschutzring aus matt verchromtem abs-spritzguss.

double side poster display pixquick A4 made of polycarbonate die-cast, silver anodized aluminium, base with step-on protection made of matt chrome plated abs die-cast.

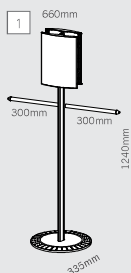

A bag soistes

1 SOBA1200

bag soistes, 1pc



1 bag soistes



banner not included

information

struttura in alluminio anodizzato argento con ripiano in acrilico satinato, base con protezione in abs colore cromo opaco.

ablage aus matt-weissem acrylglas, eloxiertes aluminium in silber, trittschützung aus matt verchromtem abs-spritzguss.

tray in white-frosted acrylic, silver anodized aluminium, base with step-on protection made of matt chrome plated abs die-cast.

1

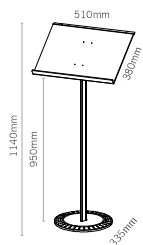

desk soistes

MADE IN EU design by KD



IT il leggjo autoportante desk, grazie al suo ripiano in acrilico satinato, le offre ampio spazio per menù, cataloghi, libri, depliant e molto altro ancora. é anche possibile personalizzare la parte frontale di desk, con una stampa digitale, grazie alla semplice aggiunta dei nostri profili a scatto bannerblock.

DE der freistehende counter desk bietet mit seiner satinierten acryl-ablage platz für menükarten, kataloge, gästepücher, verzeichnisse und vieles mehr. zusätzlich kann die vorderseite mit druck personalisiert werden. einfach ihren desk mit unserem klemmprofil bannerblock erweitern.

EN the free standing desk with its satin acrylic tray is ideal for presentation of menus, catalogues, guest books, flyers and much more. additionally you can customize the front side with prints. just expand your desk with our bannerblock extrusions.



2

aggiunta: ulteriore spazio pubblicitario con il profilo a scatto bannerblock.

upgrade: zusätzliche werbefläche mit bannerblock klemmprofil kein problem!

upgrade: additional advertising space with bannerblock extrusions no problem!

banner size:
1070mm x
500mm



A desk soistes

1	SODE2A3H	desk soistes, 1 pc
2	BBC500	bannerblock 500mm, set 2pcs



1 desk soistes



2
prestissimo wing + pixquick

prestissimo wing

MADE IN EU design by KD

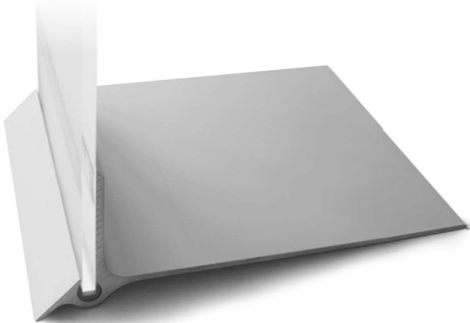

IT prestissimo wing nasce dalla combinazione geniale tra l'acrilico bisatinato color ghiaccio e la nostra base ultrasottile prestissimo. questo sistema di presentazione elegante e stabile è disponibile sia in versione pura, dunque personalizzabile e senza accessori, sia in versione fornita di tasca portainformazioni pixquick o allestita come portaprospekti e portaflyer.

DE prestissimo wing ist die clevere kombination aus hochwertigem, satiniertem acrylglas in frostoptik und unserer eleganten und extraflachen basis prestissimo. das elegante und stabile präsentationssystem gibt es in verschiedenen varianten: entweder pur, für ihre individuelle gestaltung, oder bereits bestückt mit der rahmenlosen infotasche pixquick oder als prospekt- und flyerdisplay.

EN prestissimo wing combines a white frosted acrylic with our elegant and extra flat base prestissimo. the elegant and stable information display is available in different versions: pure without any accessories for your own customizaton, equipped with our frameless poster pocket pixquick or designed as information and brochure display.

advantages

- ✓ portadepliant da terra elegante e autoportante
elegantes, freistehendes bodendisplay
elegant freestanding floor stand
- ✓ notevole stabilità
hohe standstabilität
firm and stable stand
- ✓ poco ingombrante da trasportare
geringes transportvolumen
low transport volume
- ✓ disponibilità in vari modelli
mehrere varianten zur auswahl
different models available

A prestissimo wing

	description
1	PTWG990TR prestissimo wing corpo, 1pc
2	PTWG990PQTR prestissimo wing + pixquick, 1pc
3	PTWG990COTR prestissimo wing + silicone rings, 1pc
4	VELODIVO2 velo divider for 2 A6, 2pcs

information

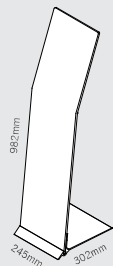

profilo in alluminio anodizzato color argento, pannello acrilico bisatinato
silber eloxiertes aluminiumprofil, paneel aus beidseitig satiniertem acrylglas
profiles made of silver anodized aluminium, panel double side satined acrylic



1
prestissimo wing corpo

prestissimo wing corpo in acrilico bisatinato
prestissimo wing corpo aus beidseitig satiniertem acrylglas

prestissimo wing corpo made of both side satin acrylic



2
prestissimo wing + pixquick

prestissimo wing pixquick: acrilico bisatinato, con porta poster pixquick A4 in policarbonato trasparente,
prestissimo wing pixquick: beidseitig satiniertes acryl mit pixquick A4 aus transparentem polycarbonat.

prestissimo wing pixquick: both side satin acrylic with pixquick A4 made of polycarbonate die-cast.



3
prestissimo wing + silicone rings

prestissimo wing: acrilico bisatinato con supporti in alluminio anodizzato e anelli in silicone per formati A4 e US letter.

prestissimo wing: beidseitig satiniertes acryl mit silber eloxierten aluminiumhaltern und silikon o-ringen für format A4 und US-letter.

prestissimo wing: both side satin acrylic with silver anodized aluminium supports and silicone o-rings for format A4 and US-letter.



4

divider: divisore in acrilico 2mm per due depliant formato DIN A6 verticale.

divider: unterteilung acrylglas 2mm für 2 prospekte DIN A6 vertikal.

divider: 2mm acrylic glass for two A6 brochures vertical



velo

MADE IN EU design by KD

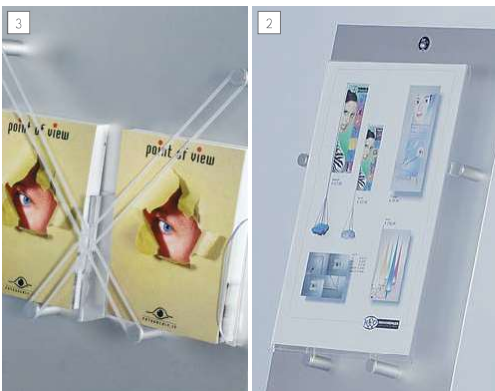

IT formato da due parti, velo si monta in un batter d'occhio. fornito di distanziatori color argento satinato, combinati con elastici trasparenti, è ideale per esporre cataloghi in DIN A4 e, grazie al divisore in acrilico, anche 2 formati DIN A6. in aggiunta, la tasca portainformazioni in formato DIN A4 si fissa sui distanziatori. sfrutti anche la parte posteriore che, grazie ai profili bannerblock, diventa un'ulteriore superficie pubblicitaria.

DE die zweiteilige grundstruktur ist schnell aufgestellt. silbermatt verchromte halter in kombination mit transparenten o-ringen machen velo zum infopanel und prospektständer. mit dem divider werden aus einem DIN A4, zwei DIN A6 fächer, die DIN A4 postertasche wird auf den haltem befestigt. eingehängt mit dem passenden bannerblock-profil wird die velo rückseite mit digitaldruck zur zusätzlichen werbefläche.

EN the two-piece base structur is mounted in no time, silver matt spacers in combination with transparent o-rings make velo a brochure rack and an infopanel as well. with the divider the A4 tray becomes two A6 trays, the A4 poster pocket is mounted on the spacers, double your marketing space by adding digital prints to a bannerblock to the rear of the velo.

information

velo pannello perforato in alluminio anodizzato spessore 3mm, base mdf laccata argento, chiusura di sicurezza design autobloccante, cavo in acciaio inox, 1 set VELOATO2 per 2 A4 incluso.

velo silber eloxiertes aluminiumpaneel mit bohrungen, silberlackierte MDF-basis selbstarretierender designverschluss, edelstahlsell, 1 set VELOATO2 für 2 DIN A4 inkl.

velo panel made of anodized aluminium with holes, base made of silver coated MDF with auto-closing lock, stainless steel wire, 1 set VELOATO2 for 2 A4 incl.

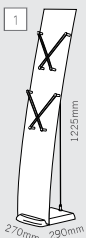

A velo		
1	VELOAA	velo, 1 pc
2	VELOA4*	velo poster pocket A4, 1 pc
3	VELODIVO2	velo divider for 2 A6, 2 pcs
4	BBVELO*	velo bannerblock set 2 pcs
5	VELOATO2	8 velo spacers, 4 o-rings, 1 set
6	VELORING140	transparent o-rings, Ø 139mm, 4 pcs
7	VELORING12*	transparent o-rings, Ø 12mm, 5 pcs

* fino ad esaurimento scorte | solange vorrat reicht | while stock last



tasca porta informazioni in acrilico, 3mm di spessore, per fogli singoli, con elastici trasparenti.

acrylglas-posterhalter 3mm für ein einzelblatt im DIN A4 format, mit transparenten o-ringen.

poster holder, 3mm acrylic glass for a single DIN A4 sheet, with transparent o-rings.

divider: divisore in acrilico 2mm per due depliant formato DIN A6 verticale.

divider: unterteilung acrylglas 2mm für 2 prospekte DIN A6 vertikal.

divider: 2mm acrylic glass for two A6 brochures vertical

2 profili di alluminio bannerblock, larghi 270 mm, per fissare ed esporre stampe digitali di spessore da 0,2mm a 0,7mm.

zwei bannerblock aluminiumprofile, breite 270mm, zur befestigung von digitaldrucken von 0,2mm bis 0,7mm.

two extrusions bannerblock made of anodized aluminium, 270mm length, to attach digital prints from 0,2mm up to 0,7mm.

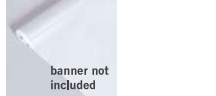

8 distanziatori in alluminio anodizzato, con 4 elastici trasparenti in silicone.

8 distanzhalter aluminium eloxiert, mit 4 transparenten silikon o-ringen.

8 spacers, anodized aluminium, with 4 transparent silicone o-rings.

4 o-ring trasparenti in silicone, Ø 139mm

4 stück transparente o-ringe aus silikon, Ø 139mm.

4 pcs transparent o-rings, made of silicone, Ø 139mm

5 piccoli o-ring trasparenti in silicone, Ø12 mm

5 stück transparente o-ringe aus silikon, Ø12mm

5 pcs transparent o-rings, made of silicone, Ø12mm



velo magic

MADE IN EU design by KD



IT velo goes magic: abbiamo dotato il pannello del velo di fessature laterali tipiche della linea magic. in questo modo è possibile utilizzare tutti gli accessori magic anche con l'espositore velo. grazie al sistema modulare magic potrà trasformare ogni volta il suo velo in modo semplice e veloce: basta scegliere di volta in volta i portacataloghi o i portainformazioni che più fanno al suo caso.

DE velo goes magic: das dibondpaneel des velo haben wir mit den magic-fräsungen versehen, damit können sie die magic accessoire auch für velo nutzen. mit dem magic system konfigurieren sie ihren velo immer wieder neu und im handumdrehen: taschen oder ablagen je nach bedarf einfach ein-, aus- und umhängen.

EN velo goes magic: the dibond panel of velo has the magic-notches so you can use your magic accessories with velo too. the magic system allows you to configure your velo in new ways again and again: just hook or unhook the brochure trays or poster pockets according to your needs.



information

velo magic: pannello in dibond con fessature laterali per l'aggancio di tutti gli accessori della serie magic, base mdf laccata argento.

velo magic: paneel aus dibond mit fräsungen für alle zubehörendelemente der magic serie zum einhängen, basis silber lackiertes mdf.

velo magic: dibond panel, with notches to hook on all elements of the magic accessories, base silver coated mdf.

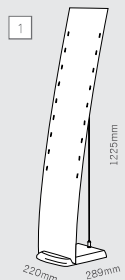

A velo magic



1	VMA165AA	velo magic, 1pc
2	PQMA4	pixquick magic A4, 1pc
3	PQMA5*	pixquick magic A5, 1pc
4	MZIP300BRPC	brochure tray A4, 1pc
5	MDIV02	magic divider for 2 A6, 1pc
6	MZ300BSAL*	magic support, 1pc

* fino ad esaurimento scorte | solange vorrat reicht | while stock last



2 pixquick magic A4 verticale: policarbonato trasparente con supporti laterali in alluminio anodizzato color argento.
pixquick magic A4 vertikal: transparentes polycarbonat, mit silber eloxierten aluminium halterungen.

pixquick magic A4 horizontal: transparent polycarbonate, with silver anodized aluminium supports.





3 pixquick magic A5 orizzontale: policarbonato trasparente con supporti laterali in alluminio anodizzato color argento.
pixquick magic A5 horizontal: transparentes polycarbonat mit silber eloxierten aluminium halterungen.

pixquick magic A5 horizontal: transparent polycarbonate, with silver anodized aluminium supports.





4 tasca portadepliant da agganciare sull'espositore in policarbonato antiriflesso e resistente ai raggi UV, per formato DIN A4.
prospektschale zum einhängen, aus uv-resistentem, bruchsicherem polycarbonat, für DIN A4 format.

brochure holder to hook on, uv-resistant, shock proof polycarbonate, for DIN A4 size.



5 magic divider acrilico trasparente, divide la tasca A4 (MZIP300BRPC) in 2 scomparti per A6, si inserisce nella tasca.
magic divider transparentes acrylglas, unterteilt durch ein Schub die prospekttasche A4 (MZIP300BRPC) in 2 A6 fächer.

magic divider transparent acrylic, put into the A4 brochure tray MZIP-300BRPC and get a place for 2 A6.



6 supporto magic in alluminio anodizzato, per cataloghi da inserire nella tasca in A4 più in alto.
magic stütze für prospekte in der obersten A4 tasche, silber eloxiertes aluminium.

magic support for brochures in the top A4 tray, silver anodized aluminium.



glass folder

MADE IN EU design by KD

IT glass folder è l'elegante e intramontabile espositore per riviste, brochure e flyer di misure diverse. Il portabrochure da terra in vetro temperato è leggermente inclinato all'indietro e appoggiato solidamente su una base in alluminio. La scelta degli optional disponibili per la personalizzazione dell'espositore è a completa discrezione del cliente, grazie alla marcatura millimetrica serigrafata accessori come tasche portaposter e ripiani possono essere fissati con precisione, cambiarne la disposizione è comunque possibile in ogni momento.

DE glass folder ist der elegante und zeitlose aufsteller zum einlegen von zeitungen, broschüren und flyer verschiedenster größen. der bodenprospekthalter aus temperiertem glas ist leicht nach hinten geneigt und steht sicher auf einer basis aus aluminium. mit wie vielen und welchen prospekttaschen und ablagen sie ihren modernen broschürenhalter gerne ausstatten möchten, das bleibt vollkommen ihnen überlassen: einfach direkt bei der bestellung ihre optionals wählen. dank der bereits aufgedruckten millimeter-markierung in siebdruck können poster taschen und regale millimetergenau fixiert werden. ein nachbestücken ist jederzeit möglich.

EN glass folder is the elegant and timeless display for magazines, brochures and flyers of various sizes. the freestanding literature display holder in tempered glass is slightly inclined backwards and firmly stands on an aluminium base. if you want to equip your display with poster pockets or trays, just choose your preferred accessories when ordering. thanks to the millimetre silkscreen marking you can perfectly fix them onto the glass display. you can rearrange it at any time.



portageggi ad altezza regolabile, adatto per esporre gadget e materiale promozionale

ablage höhenverstellbar, für kleine produkte und objekte

trays: height-adjustable for small products and objects



portaprospekti ad altezza regolabile per esporre brochure in diversi formati

prospektschale höhenverstellbar, für broschüren, flyer und zeitschriften versch. grössen

brochure pocket: height-adjustable for brochures, flyers and magazines of different sizes

information

base: profilo estruso in alluminio anodizzato color argento, verniciato a polvere color antracite; corpo in vetro temperato; ripiani in metallo verniciato a polvere color antracite

basis aluminium strang pressprofil, anthrazit pulverbeschichtet, corpus aus temperiertem glas, ablagen aus metall anthrazit pulverbeschichtet

base: silver anodized aluminium extrusion, anthracite powder-coated; body: tempered glass, anthracite powder-coated metal trays

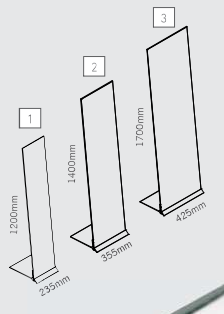
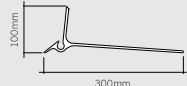

vetro temperato, pannello in vetro disponibile anche singolarmente, senza marcatura millimetrica, stampa personalizzata su richiesta

temperiertes sicherheitsglas, glaspaneel auch einzeln erhältlich, ohne millimetermarke, auf anfrage individuell bedruckbar

tempered glass, glass panel also available separately, without millimeter marking, on request we offer also individual print

10-12
1400x355mm
1700x425mm
1200x235mm

A glass folder

	description	hxb
1	GLF1200235	glass folder 1200x235mm, 1pc
2	GLF1400355	glass folder 1400x355mm, 1pc
3	GLF1700425	glass folder 1700x425mm, 1pc
4	GLFA235GR	glass folder tray 235mm, 1pc
5	GLFA355GR	glass folder tray 355mm, 1pc
6	GLFA425GR	glass folder tray 425mm, 1pc
7	GLFP235GR	glass folder poster pocket 235mm, 1pc
8	GLFP355GR	glass folder poster pocket 355mm, 1pc
9	GLFP425GR	glass folder poster pocket 425mm, 1pc
10	GLFC1200235	glass folder clear 1200x235mm, 1pc
11	GLFC1400355	glass folder clear 1400x355mm, 1pc
12	GLFC1700425	glass folder clear 1700x425mm, 1pc



advantages

- ✓ espositore per brochure di alta qualità, autoportante e stabile
hochwertiges, stabiles freistehendes bodendisplay
high quality and freestanding floor display
- ✓ montaggio veloce senza attrezzi
ohne werkzeug schnell aufgestellt
easy mounting without tools
- ✓ marcatura millimetrica serigrafata per il fissaggio preciso di ripiani e tasche portaposter
besiebdruckte millimeter-markierung zur fixierung von ablagen und prospekttaschen
millimeter silkscreen marking for tray and poster pocket fixing
- ✓ profilo in alluminio extra piatto in elegante color argento
optionals: ablagen stufenlos höhenverstellbar
options: stagelessly height-adjustable trays



mosquito

MADE IN CHINA quality control by KD



IT mosquito è la soluzione leggera come una piuma per l'impiego mobile, grazie ai suoi 2 profili di alluminio che, combinati con tessuto trasparente, fanno risparmiare peso e volume, dopo averlo estratto dalla pratica borsa per il trasporto, mosquito è pronto per l'utilizzo in un batter d'occhio. Il riuscito restyling della nuova versione colpisce grazie all'eleganza dell'aspetto e all'alta qualità dei materiali utilizzati. L'asta telescopica facilita il montaggio dell'espositore, che viene inoltre mantenuto in perfetta tensione. Due versioni, rispettivamente con 4 e 8 tasche in formato DIN A4, sono a disposizione a sua scelta. La robusta borsa per il trasporto è realizzata in tessuto di lino foderato. Mosquito: seducente grazie al suo aspetto, alla sua trasportabilità e al suo prezzo.

DE mosquito ist die federleichte Lösung für den mobilen Einsatz. Leichte Silber eloxierte Aluprofile kombiniert mit transparentem Textilgewebe sparen Gewicht und Volumen. Aus der Transporttasche genommen, ist der Mosquito nach wenigen Handgriffen im Einsatz. Das gelungene Restyling der neuen Version besticht durch elegante Optik und hochwertige Verarbeitung. Die Teleskopstange erleichtert den Aufbau und sorgt für optimale Spannung. Zwei Versionen mit vier bzw. acht DIN A4 Taschen stehen zur Auswahl. Die robuste Transporttasche ist aus gefüttertem Gewebe in Leinwandoptik. Der Mosquito: bestechend in Optik, Mobilität und Preis.

EN mosquito is as light as a feather and thus most suitable for mobile users. A combination of aluminium profiles and transparent textile fabric saves weight and volume. Once taken out of the transport bag mosquito is mounted in an instant and ready for use. Successful restyling wins over with elegant looks and high-grade materials. The telescopic bar eases setting up and keeps the fabric perfectly tight. Two versions with four or eight DIN A4 pockets are available. The robust transport bag is made of lined canvas. Mosquito: tempting by looks, mobility and price.

information

profili di alluminio anodizzato, asta telescopica, resistente tessuto color grigio argenteo, 8 o 4 tasche in formato DIN A4, borsa per il trasporto inclusa.

silber eloxierte aluminiumprofile, teleskopstange, silbergrau, strapazierfähiges textilgewebe, acht oder vier unterteilungen für DIN A4 format, inkl. transporttasche

anodized aluminium profile, telescopic bar, silvergrey fabric, eight or four pockets for DIN A4, transport bag included

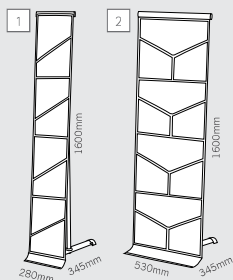

A mosquito

1	MOSN04	mosquito 4 x A4, 1pc
2	MOSN08	mosquito 8 x A4, 1pc



2 mosquito 8 x A4



fixzip

MADE IN EU design by KD



pannello crowner singolo in formato DIN A4 realizzato in acrilico di 3mm di spessore per personalizzazioni individuali.

crowner schild DIN A4 aus 3mm acrylglas zum aufstecken, für die individuelle gestaltung.

DIN A4 crowner signpost to be attached on top, 3mm acrylic glass, for individual composition and marking.



pannello crowner a tasca in formato DIN A4 realizzato in acrilico con calamite inserite a filo, per un veloce cambio di informazioni.

crowner posterhalter DIN A4 zum aufstecken, aus acrylglas mit magnetverschluss, zum schnellen austausch der information.

DIN A4 crowner poster holder to be attached on top, acrylic glass, with magnetic lock for fast exchange of information.

IT il nostro fixzip è doppiamente funzionale: leggero e stabile nella struttura, veloce nel montaggio, il porta cataloghi si monta e si smonta in pochi e semplici gesti. le 4 tasche portadepliant in acrilico antiurto sono già fissate sulla struttura ad arco, in legno, che viene montata sulla base. il cavo di acciaio incluso nella confezione unisce l'arco e la base grazie ad una chiusura di sicurezza autobloccante. grazie a fixzip in un batter d'occhio avrà a disposizione un porta cataloghi stabile ma anche straordinariamente mobile. una quinta superficie per informazioni si ottiene facilmente aggiungendo gli accessori della serie dei crowner, pannelli in acrilico da montare sulla tasca superiore dell'espositore.

DE stabil in der struktur, schnell im aufbau. der stationäre prospektständer ist mit wenigen handgriffen auf- und abgebaut. vier DIN A4 prospekttaschen aus schlagfestem acrylglas sind schon vormontiert. der spannbogen wird in die basis gestellt. das mitgelieferte edelstahlseil verbindet den spannbogen und die basis mittels selbstarretierendem verschluss. mit fixzip haben sie einen stabilen aber dennoch mobilen prospektständer. ein fünfte infoläche ermöglicht das zubehör der zip-crowner serie.

EN take advantage of fixzip's fast assembling and stable structure as well. the brochure rack is mounted and dismantled in no time at all: the four brochure pockets in DIN A4 format made of shock-resistant acrylic are already pre-assembled, insert the arc into the base, the stainless steel wire provided connects arc and base with the auto-closing lock. you get a solid and likewise mobile brochure rack. obtain a fifth information panel with the accessories of the zip crowner series.

information

base in MDF color argento metallizzato, struttura ad arco in betulla multistrato ricoperta anteriormente da alluminio anodizzato, già montata con le 4 tasche portadepliant in acrilico antiurto, cavo in acciaio inox.

birkenschichtholz spannbogen, frontabdeckung aus eloxiertem aluminium, MDF basis silbermetallisch lackiert, 4 DIN A4 prospekttaschen aus schlagfestem acrylglas vormontiert, edelstahlseil.

arc made of multi-layer birchwood front cover anodized aluminium, silver varnished MDF base, 4 DIN A4 brochure pockets made of shock-resistant acrylic glass pre-assembled, stainless steel cable.

base in acero impiallacciato, struttura ad arco in betulla multistrato ricoperta anteriormente da alluminio anodizzato, già montata con le 4 tasche portadepliant in acrilico antiurto, cavo in acciaio inox.

birkenschichtholz spannbogen, frontabdeckung aus eloxiertem aluminium, basis aus aluorn furniert, 4 DIN A4 prospekttaschen aus schlagfestem acrylglas vormontiert, edelstahlseil.

arc made of multi-layer birchwood front cover anodized aluminium, maple veneer base 4 DIN A4 brochure pockets made of shock-resistant acrylic glass pre-assembled, stainless steel cable.



FZIP165AA

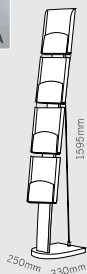

FZIP165HP

A fixzip

1	FZIP165AA*	fixzip silver base, 1 pc
2	FZIP165HP*	fixzip maple veneer base, 1 pc
3	CZIPO1_SINGLE *	crowner signpost A4, 1 pc
4	CZIPO2_SLEEVE *	crowner poster holder A4, 1 pc

* fino ad esaurimento scorte | solange vorrät reicht | while stock last



1
fixzip



zip divider restyle: restyling del divisore in acrilico trasparente, per 2 A6 verticali.

zip divider restyle: transparentes acryl, unterteiler für prospekttasche in 2 A6 fächer.

zip divider restyle: transparent acrylic, divides the A4 brochure pocket into 2 A6 trays



solid zip

MADE IN EU design by KD

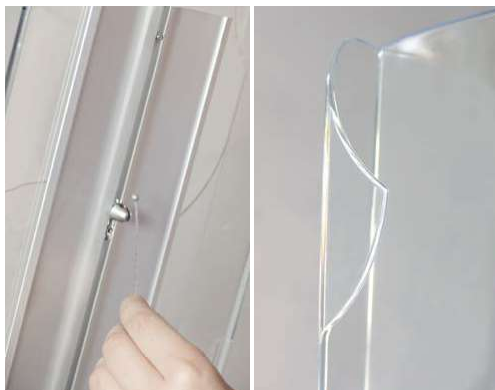

IT solid zip le offre tutti i vantaggi di un espositore autoportante mantenendo tuttavia caratteristiche di leggerezza e facilità nel montaggio e durante il trasporto. le 4 tasche stampate ad iniezione in policarbonato antirullo sono resistenti ai raggi uv e durevoli. praticità d'uso: il design intelligente impedisce che i fogli singoli cadano in avanti. robusta e tuttavia elegante, la struttura dell'espositore è realizzata in alluminio anodizzato. un consiglio: usi solid zip anche per i depliant in formato A6! basta inserire il divider che divide in due parti la tasca A4.

DE solid zip bietet ihnen alle vorteile eines stationären prospektständers und ist dabei leicht im handling bei aufbau und transport, die vier spritzgusstaschen aus schlagfestem polycarbonat sind uv-beständig und langlebig, praktisch: das smarte design verhindert, dass einzelblätter aus der tasche nach vorne kippen. robust und dennoch elegant in der anmutung ist die taschenstrebe aus silber eloxiertem aluminium. unser tip: auch für A6 prospekte geeignet, einfach zip divider einschieben und die A4 tasche teilen.

EN solid zip has all advantages of a permanent brochure holder and yet it is easy to handle and transport. the four die-cast brochure pockets, made of shock-resistant polycarbonate, are uv-resistant and durable as well. convenient: the smart design prevents single sheets from bending forward, the pocket support made of silver anodized aluminium is sturdy and gives an elegant impression. our tip: suitable for A6 formats also, just insert the zip divider and dissect the A4 pocket.

information

4 tasche formato DINA4 in pollicarbonato antirullo, montate su una struttura di alluminio anodizzato, base mdf laccata argento, con chiusura di sicurezza design autobloccante

vier schlagfeste spritzgusstaschen aus polycarbonat, vormontiert auf silber eloxiertem aluminiumprofil, basis silber lackiertes mdf mit matic-halter für stahlsel .

four shock-resistant brochure pockets, made of die-cast polycarbonate, pre-mounted on silver anodized aluminium profile, base silver coated mdf with matic-lock-support for steel cable

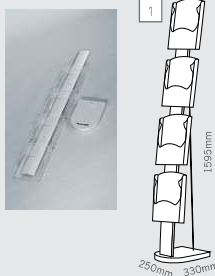

A solid zip

1 SOZ165AL solid zip, 1pc

2 DNZIPO2 zip divider restyle, set 2pcs



1 solid zip



sailzip

MADE IN EU design by KD

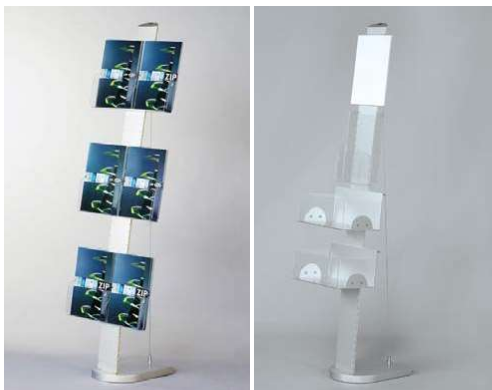

IT sailzip offre una vasta gamma di combinazioni, per creare presentazioni in modo sempre diverso ma con il minimo sforzo. facile e veloce da montare, la struttura è tenuta in tensione grazie al cavo in inox e alla chiusura autobloccante di sicurezza. gli accessori, di diverse forme e dimensioni, sono utilizzabili sempre a libera scelta: li combini a piacere per creare il suo sempre nuovo e sempre diverso sailzip.

DE maximale kombinationsmöglichkeiten, minimaler aufwand? das ist sailzip. in die basis eingesteckt wird der spannbogen durch ein edelstahlseil im selbst-arretierenden verschluss gehalten. aus dem zubehör programm wählen sie die elemente. anschließend beliebig kombinieren und im bogen ein- oder aus-hängen

EN maximum variety of combination, minimum effort? that's sailzip. insert the arc into the base, the stainless steel wire provided connects the arc and base with the auto-closing lock. choose your accessories and combine them at will. the elements are easily attached to the arc again and again freely any time.



A sailzip

1	SAIL165AA	sailzip silver base, 1 pc
2	SAIL165HP*	sailzip maple veneer base, 1 pc
3	SAIL700500	poster pocket, 700x500 (hxD), 1 pc
4	SAILPPA5	brochure pocket A5, vertical, 1 pc
5	SAILPPA4	brochure pocket A4, vertical, 1 pc
6	SAILPPA3	brochure pocket A3, horizontal, 1 pc
7	SAILVASC	container, 1 pc
8	SAILA4V	poster holder A4 vertical, 1 pc
9	SAILA4H	poster holder A4 horizontal, 1 pc
10	SAILA3V	poster holder A3 vertical, 1 pc
11	SAILA3H	poster holder A3 horizontal, 1 pc

* fino ad esaurimento scorte | solange vorrat reicht | while stock last
 ** price on request



2 + 3 + 6
 sailzip maple veneer base
 + sailposter 700x500
 + brochure pocket A3



tasca portaposter in acrilico antiurto, formato 700x500mm (hxD)

posterlasche aus schlagfestem acrylglas 700x500mm (hxb)

poster holder, shock-resistant acrylic, 700x500mm (hwx)



tasca portadepipliant in acrilico antiurto, formato DIN A5 o A4 verticale

prospektlasche aus schlagfestem acrylglas im DIN A5 oder A4 format vertikal

brochure pocket made of shock-resistant acrylic, A5 format or A4 vertical

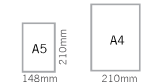

tasca portadepipliant in acrilico antiurto, formato DIN A3 orizzontale; il divisore centrale, mobile, permette di dividere la tasca in due A4 verticali.

prospektlasche aus schlagfestem acrylglas im DIN A3 format horizontal, durch einhaken der flexiblen mittelteilung 2 A4 vertikal fächer

brochure pocket made of shock-resistant acrylic, A3 format horizontal, hook in the middle divider get 2 A4 vertical



contenitore per prodotti in acrilico antiurto con fondo in alluminio anodizzato, misure 120x295x195mm (hxbxp)

produktschütze aus schlagfestem acrylglas mit boden aus eloxiertem aluminium 120x295x195mm (hxbxt)

container made of shock-resistant acrylic with bottom made of anodized aluminium 120x295x195mm (hxbxd)



tasca portaposter in acrilico antiurto, formato DIN A4 verticale o formato DIN A4 orizzontale

posterlasche aus schlagfestem acrylglas im DIN A4 format vertikal oder DIN A4 format horizontal

poster holder, shock-resistant acrylic, DIN A4 format vertical or DIN A4 format horizontal

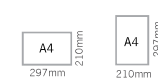

tasca portaposter in acrilico antiurto, formato DIN A3 verticale o formato DIN A3 orizzontale

posterlasche aus schlagfestem acrylglas im DIN A3 format vertikal oder DIN A3 format horizontal

poster holder, shock-resistant acrylic, DIN A3 format vertical or DIN A3 format horizontal

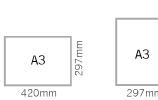



flashzip soistes

MADE IN EU design by KD

IT flashzip è un portadepliant autoportante con 5 ripiani in polycarbonato per prospetti in formato A4, con poster clip le stampe si possono fissare sotto i ripiani stessi personalizzando quindi flashzip con il proprio logo, con una grafica o uno slogan. un poster clip è già incluso nel pacchetto flashzip.

DE flashzip ist ein freistehender prospektpräsentier mit 5 polycarbonat-ablagen für A4 prospekte. mit dem poster clip werden drucke von unten an die ablagen befestigt werden, so personalisieren sie ihren flashzip im handumdrehen entweder mit logo, grafik oder passenden slogans. ein poster clip ist im lieferumfang schon dabei.

EN flashzip is a freestanding brochure holder with 5 polycarbonate trays in A4 format. with the poster clip fix your prints on the under side of the trays and customize your flashzip with a logo or information. one poster clip is already included.



flash poster clip pannello A4 in acrilico per personalizzare le tasche con una stampa.

flash poster clip A4 pannel in acryl für personalisierung der taschen mit druck.

flash poster clip A4 acrylic panel for customizing the trays with print

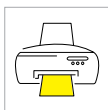

information

base flashzip con protezione in abs, profili in alluminio anodizzato color argento, 5 tasche in polycarbonato per formato A4, 1 poster clip.

flashzip basis abs trittschutz, silber eloxiertes alu-profil, 5 ablagen in polycarbonat A4, 1 poster clip.

flashzip base abs step-on protection, silver anodized aluminium, 5 polycarbonate trays A4, 1 poster clip.

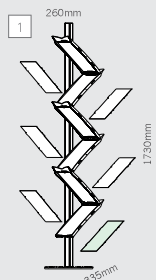

A flashzip soistes

1	FL170AL*	flash zip, 1pc	
2	FLCA4P*	flash poster clip A4, 1pc	



* fino ad esaurimento scorte | solange vorrat reicht | while stock last



zipzac soistes

MADE IN EU design by KD

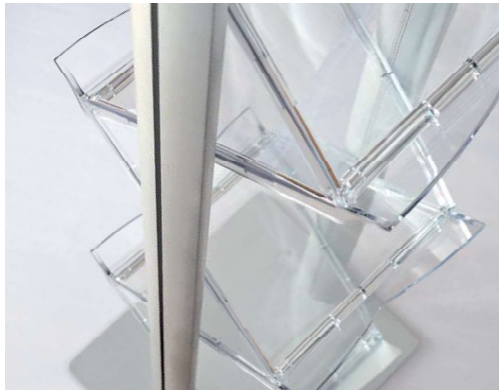

IT zipzac è un portadepliant per cataloghi di formato A4 realizzato con profili in alluminio anodizzato, formato da 6 ripiani in policarbonato stampato ad iniezione e da una stabile base verniciata a polvere in argento metallizzato, tutti i ripiani, grazie all'accessorio posterclip, possono essere personalizzati con una semplice stampa. inoltre, zipzac si può personalizzare anche grazie all'aggiunta di un pannello superiore o di crowner media, per presentazioni multimediali.

DE mit zipzac erhalten sie 6 ablagen aus polycarbonat-spritzguss für kataloge im A4 format auf stabiler pulverlackbeschichteter metallbasis und silbereloxierten aluminium profilen. alle ablagen können mit dem posterclip schnell und einfach mit druck personalisiert werden. ausserdem lässt sich ihr zipzac mit einem top-schild oder sogar einem crowner media für audiovisuelle präsentation erweitern.

EN with zipzac you get 6 trays made of die-cast polycarbonate for A4 brochures. zipzac comes on a stable base made of powder coated metal and silver anodized aluminium profiles. all trays can be easily customized with the poster clip. besides that you can upgrade your zipzac with a top sign or a crowner media for audiovisual presentation.



flash poster clip pannello A4 in acrilico per personalizzare le tasche con una stampa.

flash poster clip A4 pannel in acryl für personalisierung der taschen mit druck.

flash poster clip A4 acrylic panel for customizing the trays with print

A zipzac soistes		
1	ZZC1500*	zipzac soistes, 1pc
2	FLCA4P*	flash poster clip A4, 1pc

* fino ad esaurimento scorte | solange vorrat reicht | while stock last

information

base verniciata a polvere, profili di alluminio anodizzato color argento, 6 ripiani in policarbonato in formato A4.

basis silber pulverlackbeschichtet, silber eloxiertes alu-profil, 6 ablagen in polycarbonat A4.

base silver metallic powder coated metal, silver anodized aluminium, 6 polycarbonate trays A4.

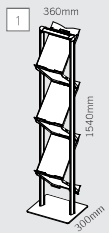

bigflash soistes

MADE IN EU design by KD



IT bigflash ha 10 ripiani in policarbonato per prospetti in formato A4, i ripiani possono essere montati parallelamente oppure sfasati. con flash poster clip potrà fissare delle stampe sotto il ripiano personalizzando così il suo bigflash in un batter d'occhio. con bigflash riceverà 2 poster clip incluse.

DE bigflash hat 10 polycarbonat-ablagen für A4 prospekte für sie. die ablagen können parallel oder versetzt montiert werden. mit dem poster cover befestigen sie drucke von unten an den ablagen und ihr flashzip ist im handumdrehen passend mit druck personalisiert. bei bigflash sind 2 poster clip schon dabei.

EN bigflash has 10 polycarbonate trays for A4 brochures. you can mount the trays parallel or offset. with poster cover you fix your prints on the under side of the trays, customizing your bigflash in no time. bigflash comes already with 2 poster clip.

information

base bigflash con protezione in abs, profili di alluminio anodizzato color argento, 10 tasche in policarbonato per formato A4, 2 poster clip.

bigflash basis abs trittschutz, silber eloxiertes alu-profil, 10 ablagen in polycarbonat A4, 2 poster clips.

bigflash base abs step-on protection, silver anodized aluminium, 10 polycarbonate trays A4, 2 poster clips.

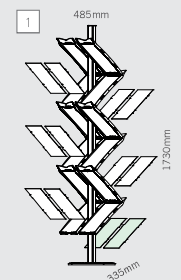

flash poster clip pannello A4 in acrilico per personalizzare le tasche con una stampa.

flash poster clip A4 pannel in acryl für personalisierung der taschen mit druck.

flash poster clip A4 acrylic panel for customizing the trays with print.

A bigflash soistes		
1	BFL170AL*	bigflash, 1pc
2	FLCA4P*	flash poster clip A4, 1pc

* fino ad esaurimento scorte | solange vorrat reicht | while stock last





information

base flagflash con protezione in abs, profilo in alluminio anodizzato color argento, 5 tasche in policarbonato per formato A4, 1 poster clip, profilo ad incastro bannerblock 500mm.

flagflash basis abs trittschutz, silber eloxiertes alu-profil, 5 ablagen in polycarbonat A4, 1 poster clip, klemmprofil für banner 500mm.

flagflash base abs step-on protection, silver anodized aluminium, 5 polycarbonate trays A4, 1 poster clip, profile for banner 500mm.

A flagflash soistes

1	FFL170AL*	flagflash, 1pc
2	FLCA4P*	flash poster clip A4, 1pc

* fino ad esaurimento scorte | solange vorrat reicht | while stock last

flagflash soistes

MADE IN EU design by KD

flash poster clip pannello A4 in acrilico per personalizzare le tasche con una stampa.

flash poster clip A4 pannel in acryl für personalisierung der taschen mit druck.

flash poster clip A4 acrylic panel for customizing the trays with print.

IT flagflash presenta 5 ripiani autoportanti in policarbonato per depliant in formato A4 insieme alle sue stampe di 500mm con il profilo bannerblock, anche con flagflash si possono inserire sotto i ripiani, grazie a poster clip, delle stampe per aggiungere spazio pubblicitario o informativo, ogni fornitura contiene 1 poster clip.

DE flagflash präsentiert freistehend 5 polycarbonat-ablagen für A4 prospekte sowie ihre 500mm drucke mit dem klemmprofil banner block, auch bei flagflash können mit dem poster cover drucke von unten an den ablagen für zusätzliche werbe- oder infoläche befestigt werden, ein poster clip ist im lieferumfang enthalten.

EN flagflash presents freestanding trays for 5 A4 brochures and your 500mm prints with the bannerblock extrusion, flagflash also gives you the possibility to customize the trays with poster clip from the under side, we provide flagflash already with one poster clip.

fisaggio banner con bannerblock, il profilo ad incastro in alluminio.

bannerbefestigung mit bannerblock, dem silber eloxiertem klemmprofil.

banner mounting with bannerblock, the silver anodized clamp profile.

A flagflash soistes

1	FFL170AL*	flagflash, 1pc
2	FLCA4P*	flash poster clip A4, 1pc

* fino ad esaurimento scorte | solange vorrat reicht | while stock last



information

struttura in alluminio anodizzato argento con portainformazioni pixquick in formato A4 e tasche portadepliant in policarbonato stampato ad iniezione applicati mediante pannello in alluminio composto, base con protezione in abs color cromo opaco.

einzelblattpräsentation pixquick format A4 und prospektschalen aus polycarbonat-spritzguss, silbermattes aluminium verbund paneel, eloxiertes aluminium in silber, trittschutzring aus matt verchromtem abs-spritzguss

information display pixquick A4 and brochure trays made of polycarbonate die-cast, silver matt aluminium composite panel, silver anodized aluminium, base with step-on protection made of matt chrome plated abs die-cast.

A magica soistes

1	SOMA1930SET*	magica soistes, 1pc
---	--------------	---------------------

* fino ad esaurimento scorte | solange vorrat reicht | while stock last

magica soistes

MADE IN EU design by KD

magica soistes

IT la struttura magica soistes le permette di utilizzare tutti gli accessori della linea magic zip; in questa sede le presentiamo una composizione formata da 4 tasche magic in policarbonato e da un porta poster pixquick in formato A4, gli accessori si agganciano semplicemente alle fessure laterali del pannello, in alluminio anodizzato color argento, e si possono cambiare e posizionare a proprio piacimento.

DE die magica struktur ermöglicht die verwendung aller accessoires der magic zip serie, hier haben wir ihnen bereits ein set mit 4 magic polycarbonat-taschen und einer A4 pixquick postertasche zusammengestellt, alle teile werden ganz einfach in die fräsungen des silber eloxierten aluminiumpaneels ein-, aus- und umgehängt.

EN the magica structure allows you to use all the accessories of the magic zip range, here we have put together a set with 4 magic brochure pockets and 1 A4 pixquick poster pocket, all made of shock-resistant die-cast polycarbonate, all items can be easily rearranged by just inserting them into the notches on the silver anodized aluminium panel.

A magica soistes

1	SOMA1930SET*	magica soistes, 1pc
---	--------------	---------------------

* fino ad esaurimento scorte | solange vorrat reicht | while stock last



print not included

information

3 ripiani stampati formato A4, alluminio anodizzato coloro argento, protezione in abs, pannello in alluminio composito.

3 A4 ablagen aus kunststoffspritzguss, silber eloxiertes aluminium profil, abs trittschutzring, aluminium verbundpaneel.

3 trays for A4 made of die-cast synthetic material, silver anodized aluminium, abs-protection, aluminium composite panel.

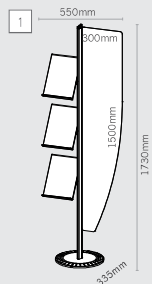

trend soistes

MADE IN EU design by KD



inclinazione del ripiano regolabile in 4 diverse posizioni.

ablagen-neigung vierfach regelbar.

4 different tray inclinations possible

IT trend soistes é un display da terra autoportante con 3 ripiani portacataloghi in formato A4 verticale con un bordo di 3cm, i ripiani si possono disporre liberamente su tutta la lunghezza del profilo e sono inclinabili orizzontalmente in 4 differenti angolature. Il pannello di alluminio composito, verniciato in color argento e con uno spessore di 3 mm, può essere decorato con una stampa. I morsetti laterali sono di ottone verniciato color argento.

DE trend soistes bietet ihnen als freistehendes bodendisplay 3 A4 ablagen aus satiniertem acryl mit 3cm rand, die ablagen sind höhenverstellbar sowie vierfach horizontal neigbar, das silbergrau beschichtete 3mm starke aluverbundpaneel kann dekorativ bedruckt oder beklebt werden, die paneelhalter sind aus versilbertem messing.

EN trend soistes is a free standing display with 3 A4 trays made of satinized acrylic with a 3cm lip, the trays are adaptable horizontally and can be regulated in height as well, the silvergrey coated 3mm thick aluminium composite panel can be customized with print, the panel supports are made of silver-plated brass.

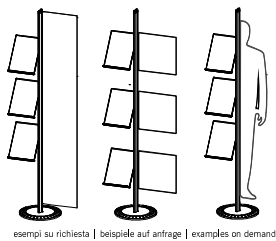
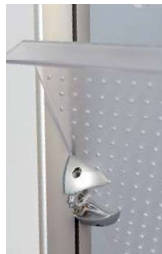

esempi su richiesta | beispiele auf anfrage | examples on demand

A trend soistes

1 SOTR1730*

trend soistes, 1pc



* fino ad esaurimento scorte | solange vorrat reicht | while stock last



1 palo soistes

palo soistes

MADE IN EU design by KD



inclinazione del ripiano regolabile in 4 diverse posizioni.

ablagen-neigung vierfach regelbar.

4 different tray inclinations possible

IT grazie a palo avrá a disposizione un espositore da terra autoportante composto da 8 ripiani in formato A4, i ripiani in acrilico sono regolabili in altezza ed in quattro gradi di inclinazione, che si tratti di esporre fogli singoli o cataloghi, con gli eleganti ripiani in acrilico satinato fará sempre e comunque un'ottima figura.

DE mit palo bekommen sie ein freistehendes und stabiles bodendisplay für 8 A4 formate, die acrylglasablagen lassen sich horizontal 4-fach neigen und stufenlos höhenverstellen, ob einzelblatt- oder katalogpräsentation mit den elegant satinierten acrylablagen machen sie immer gute figur.

EN with palo from the soistes range you get a free standing display with 8 A4 sized trays, the acrylic trays are adaptable horizontally and can be regulated in height, appealing and stylish presentation of brochures and catalogues is what palo will provide you.

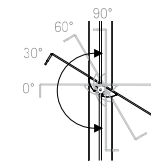

information

4 ripiani in acrilico satinato per 8 formati A4 con bordo di 30mm all'estremità, base con protezione in abs, profilo in alluminio anodizzato color argento.

4 ablagen aus satiniertem acryl für 8 formate A4, rand 30mm, basis mit abs-trittschutzring, profil aus silber eloxiertem aluminium.

4 satin acrylic trays for 8 A4, tray lip is 30mm lip, base with abs protection, profile silver anodized aluminium.

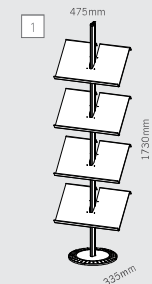

A palo soistes

1 SOPA8A4

palo soistes, 1pc





kombi soistes

MADE IN EU design by KD



Il sistema laterale di fissaggio a molla tensiona perfettamente i suoi banner.
gefederter befestigung, faltenlose spannung für ihr banner
spring loaded supports tenses your banner without creases

IT con kombi in un unico elemento avrà la possibilità di presentare cataloghi e stampe digitali. i quattro ripiani di presentazione possono essere inclinati fino alla posizione orizzontale e offrono tanto spazio per il suo materiale pubblicitario in formato A4. infili le barre di sostegno nell'asola del banner precedentemente approntata e il gioco è fatto, le barre inoltre possono essere regolate in altezza per consentire diverse possibili lunghezze del banner e allo stesso tempo per garantirne la migliore tensione

DE mit kombi verbinden sie katalog- und digitaldruckpräsentation ganz perfekt. die vier ablagen sind vierfach neigbar und bieten viel platz für printmaterial in A4. für die befestigung des drucks, schieben sie die haltestangen durch den banner-saum, die höhe der stangen ist stufenlos einstellbar, so wird ihr banner optimal gespannt und sie sind in der bannerlänge flexibel.

EN with kombi you merge perfectly the presentation of brochures and print perfectly. the four trays can be inclined horizontally and offer lots of space for your information material in A4. to mount the banner just push the bars through the seam of the banner. the height of the bars can be infinitely adjusted in height. thus your banner is kept perfectly taut and the banner length is flexible.

other possible combinations on demand!



print soistes

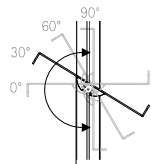

inclinazione del ripiano regolabile in 4 diverse posizioni.

ablagen-neigung vierfach regelbar.

4 different tray inclinations possible

A kombi soistes

1 SOK04A4

kombi soistes, 1pc



1 kombi soistes

banner not included

information

profili in alluminio anodizzato color argento, connettori in metallo stampato color argento, ripiani stampati formato A4.

silber eloxierte aluminium profile, verbindner aus versilbertem metalldruckguss, ablagen A4 kunststoffspritzguss.

silver anodised aluminium profiles, connectors made of silver-plated die-cast metal, trays A4 made of die-cast synthetic material.

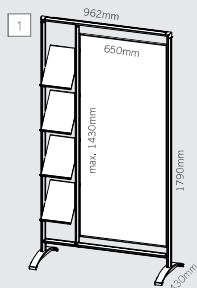



compact soistes

MADE IN EU design by KD



IT compact è il display autoportante dalla serie soistes per tre o quattro ripiani A4, per tutte le sue presentazioni di depliant. i ripiani sono inclinabili in quattro posizioni e possono essere regolati in altezza sul profilo a proprio piacimento.

DE compact das stabile bodendisplay aus der soistes serie bietet ihnen drei bzw. vier A4 ablagen für ihre katalogpräsentation. alle ablagen sind vierfach neigbar und können in der höhe stufenlos verstellt werden.

EN compact, the freestanding floor display of the soistes series, offers you three resp. four A4 trays for your brochure presentation. all trays can be inclined in four positions and infinitely adjusted in height.

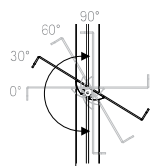

inclinazione del ripiano regolabile in 4 diverse posizioni.
 ablagen-neigung vierfach regelbar.
 4 different tray inclinations possible

information

profili di alluminio anodizzato color argento, connettori stampati a pressofusione in zamac color argento, ripiani in policarbonato stampato ad iniezione, base in metallo verniciato a polvere color argento.

silber eloxierte aluminiumprofile, versilberte metalldruckguss verbinder, polycarbonatspritzgussablagen, metallic pulverbeschichtete metallbasis.

silver anodized aluminium profiles, silver-plated metal die-cast supports, polycarbonate die-cast trays, silver powder coated metal base.

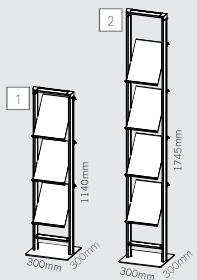

A compact soistes

1	SOCC3A4	compact 3 A4, 1pc
2	SOCC4A4	compact 4 A4, 1pc



2 compact 4 A4



1 rack soistes

rack soistes

MADE IN EU design by KD



IT il rack della linea soistes é composto da 3 robusti ripiani in acrilico satinato ognuno per 3 depliant, formato A4, ogni ripiano é regolabile indipendentemente dagli altri in altezza e inclinabile in orizzontale, il bordo dei ripiani (3cm) fa si che tutto rimanga al suo posto, grazie alle rotelle rack, soistes é sempre al posto giusto, materiali: alluminio anodizzato e metallo pressofuso color argento.

DE mobiles rack mit 3 ablagen für je 3 A4 aus satiniertem acryl, alle ablagen lassen sich unabhängig voneinander vierfach horizontal neigen und stufenlos höhenverstellen, der 3cm hohe rand hält dabei alles am platz, durch die leichtlaufrollen ist das rack jederzeit am richtigen ort schnell im einsatz, materialien: silber eloxierte aluminium-profile und versilberter metalldruckguss.

EN the mobil soistes rack is made up of 3 shelves in satin acrylic, each for 3 A4 format side by side, each individual shelf can be inclined independently from the others horizontally and every tray is freely adjustable in height, the lip of the shelf is 3cm high which keeps everything in its place, thanks to the wheels you can always put your rack in the right place, materials: silver anodised aluminium extrusions and silver-plated die-cast metal.

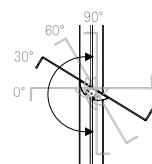

inclinazione del ripiano regolabile in 4 diverse posizioni.

ablagen-neigung vierfach regelbar.
4 different tray inclinations possible

information

profili in alluminio anodizzato color argento, connettori in metallo stampato color argento, 3 ripiani in acrilico satinato.

silber eloxierte aluminium profile, verbindner aus versilbertem metalldruckguss, 3 ablagen aus satiniertem acrylglass.

silver anodised aluminium profiles, connectors made of silver-plated die-cast metal, 3 trays made of satin acrylic.

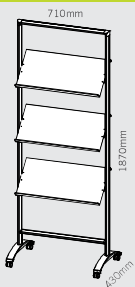

A rack soistes

1 SORA9A4

rack soistes, 1pc



1 minirack soistes

minirack soistes

MADE IN EU design by KD



IT il fratellino del rack soistes, con i suoi due ripiani ognuno per 3 A4 in acrilico satinato, é altrettanto pratico e mobile, i ripiani si possono inclinare indipendentemente l'uno dall'altro e riporre sulla struttura all'altezza desiderata, il bordo dei ripiani, di 3 cm, serve di appoggio per i cataloghi, grazie alle rotelle, minirack é sempre flessibile e mobile, materiali: profili in alluminio anodizzato color argento e connettori in metallo stampato color argento.

DE der kleine bruder des mobilen soistes racks ist mit seinen 2 ablagen für je 3 A4 aus satiniertem acryl ebenso praktisch und mobil, alle ablagen lassen sich unabhängig voneinander neigen und stufenlos höhenverstellen, der 3cm hohe rand hält dabei alles am platz, dank der leichtlaufrollen ist auch minirack immer mobil und flexibel, materialien: silber eloxierte aluminium-profile und versilberter metalldruckguss.

EN the little brother of our mobile soistes rack comes with two shelves in satin acrylic, each for 3 A4 format side by side, each individual shelf can be inclined and is freely adjustable in height, the 3cm high front lip keeps everything in its place, wheels make the minirack flexible and always mobile, materials: silver anodised aluminium extrusions and silver-plated die-cast metal.

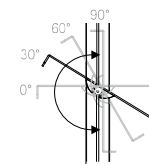

inclinazione del ripiano regolabile in 4 diverse posizioni.

ablagen-neigung vierfach regelbar.
4 different tray inclinations possible

information

profili in alluminio anodizzato color argento, connettori in metallo stampato color argento, 2 ripiani in acrilico satinato.

silber eloxierte aluminium profile, verbindner aus versilbertem metalldruckguss, 2 ablagen aus satiniertem acrylglass.

silver anodised aluminium profiles, connectors made of silver-plated die-cast metal, 2 trays made of satin acrylic.

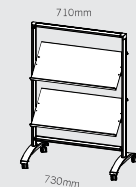

A minirack soistes

1 SORA6A4

minirack soistes, 1pc



1 + 2
cubic soistes

cubic soistes

MADE IN EU design by KD



IT grazie a cubic vedrà com'è facile attirare l'attenzione, oltre ad avere molto spazio disponibile per esporre la sua documentazione, questo espositore, composto da ripiani a forma di S su profilo soistes, conquisterà anche lei. cosa le offre cubic? dal design trendy, è un espositore da terra stabile che rende facile prendere i cataloghi ivi esposti da diverse angolazioni.

DE mit cubic ist ihnen die aufmerksamkeit sicher und sie haben jede menge platz für print-material aller art. diese kombination aus s-förmiger ablage und soistes profil wird auch sie begeistern. trendige optik, stabiler stand und leichter zugriff von verschiedenen seiten sind vorteile der katalogpräsentation, die cubic ihnen bietet.

EN with cubic you will be for sure attract all the intrest. lots of space for print material of all kinds. let yourself be inspired by the combination of s-shape shelf and soistes profile. trendy look, stable stand and easy access from different directions are advantages of catalogue presentation, that cubic provides to you.



aggiunta: possibilità di personalizzare o aggiungere ulteriore spazio pubblicitario grazie a pixquick.

upgrade: personalisierung und zusätzliche werbefläche mit pixquick postertasche gewinnen!

upgrade: customize cubic with poster pocket pixquick and gain further advertising area!



A cubic soistes

1	SOCU1100	cubic, 1pc	
2	PQA4	pixquick A4, 1pc	



information

alluminio composto color argento, base metallo verniciato argento, profili in alluminio anodizzato color argento.

silber metallic alu-verbundpaneel, silber lackierte metalbasis, silber eloxierte alu-profile.

silver metallic coated aluminium composite panels, silver coated metal base, silver anodised aluminium extrusions.

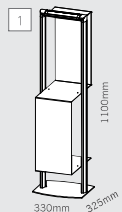

1
wallmate soistes

wallmate soistes

MADE IN EU design by KD

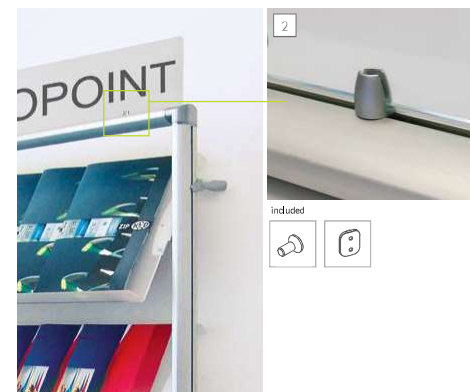

IT wallmate è la scelta ideale per una presentazione a parete. i tre ripiani in acrilico satinato offrono infatti ampi spazi di esposizione e sono adatti a contenere deplianti, cataloghi, ma anche libri, riviste e quotidiani. i ripiani si possono disporre a piacimento su tutta l'altezza del profilo laterale. wallmate si adatta ottimamente ad ambienti classici e moderni. con crownerfix, inoltre, potrà montare il pannello superiore in modo semplice e veloce ed ottenere così un wallmate personalizzato ed un'ulteriore superficie pubblicitaria.

DE wallmate ist ihre optimale wahl für die elegante, wandmontierte präsentation. drei satinierte acrylglas-ablagen bieten ausreichend platz für kataloge, brochüren, bücher und sogar grossformatige zeitung. die ablagen können sie in der höhe stufenlos auf die gewünschte höhe einstellen. wallmate passt hervorragend in moderne wie klassische ambiente. und mit crownerfix können sie topschilder einfach montieren und so ihren wallmate auch noch schnell und einfach personalisieren.

EN wallmate is your choice for an elegant, wall mounted catalogue presentation. three satin acrylic trays offer lots of space and are perfect for flyers and brochures as well as large format newspapers. you can adjust the trays in height according to your needs. wallmate matches perfectly with modern and classic ambience as well. with crownerfix you can mount top signs quickly, customizing your wallmate easily.

information

alluminio anodizzato color argento, ripiani in acrilico satinato.

silber eloxiertes aluminiumprofil, ablagen aus satiniertem acrylglas.

silver anodised aluminium, trays made of satin acrylic.

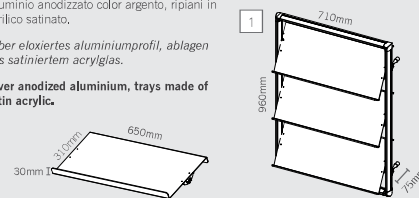

crownerfix: morsetto per il montaggio di crowner con uno spessore massimo di 4mm, ottone color argento.

crownerfix: zur befestigung von topschildern mit max. 4mm stärke aus versilbertem messing.

crownerfix: for crowner panels mounting with max. 4mm thickness made of silver-plated brass.



A wallmate soistes

1	SOWM960	wallmate, 1pc	
2	SOCF1515ARset	set, 2pcs	





realzip flexi

MADE IN EU design by KD



IT 4 tasche portacataloghi in policarbonato trasparente, con alette laterali per evitare la caduta dei fogli singoli, compongono un espositore stabile e sicuro. Le barre laterali ergonomiche in alluminio anodizzato e la composizione a forma di scala consentono di prendere comodamente i cataloghi. Il pannello frontale in alluminio è perfetto per essere personalizzato con una stampa diretta o pellicola adesiva, vuoi che sia sempre aggiornato? Ordina le eleganti tasche portainformazioni pixquick, linfor o smartquick per cambiare le informazioni con la massima velocità. Puoi fissarle al pannello frontale tramite nastro biadesivo.

DE vier A4 polycarbonat spritzguss taschen mit einzelblattkippschutz entfalten sich im handumdrehen zum standfesten display, stufenförmige staffelung und ergonomisch geformte seitenstreben aus silber eloxiertem aluminium gewährleisten perfekte entnahme von prospektmaterial. das frontpaneel aus aluminium eignet sich hervorragend für die personalisierung mit folie oder direktdruck. stets aktuelle informationen gewünscht? sie können die eleganten postertaschen pixquick, linfor oder smartquick optional dazubestellen für einen super schnellen infoaustausch. einfach mittels klebeband auf dem frontpaneel fixieren.

EN 4 die-cast polycarbonate brochure pockets unfold in no time at all into an elegant display, staggered arrangement and the ergonomically curved aluminium side braces guarantee easy access to the printed material. be always up to date! just order the elegant poster pockets pixquick, linfor or smartquick for a super quick information exchange. you can simply fix them to the front panel by an adhesive strip.



personalizzazione semplice e veloce grazie al portainformazioni pixquick, linfor o smartquick
 schnell und einfach personalisieren mit pixquick, linfor transparent oder smartquick
 quick and easy customizing with pixquick, linfor transparent or smartquick.

information

4 tasche porta depliant A4 in policarbonato antiurto, base in mdf laccata color argento satinato, parti laterali in alluminio anodizzato.

4 prospekttaschen DIN A4 aus schlagfestem polycarbonat, basis silbermatt lackiertes mdf, seitenstreben silber eloxiertes aluminium.

4 brochure pockets for DIN A4 format made of shock-resistant polycarbonate, silver varnished mdf base, side parts made of silver anodized aluminium.

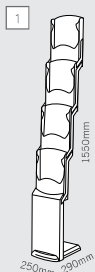

A realzip flexi

1	RZ4AAOPQ	realzip flexi, 1 pc
2	PQA4	pixquick A4, 1 pc
3	LINFORA4TR	linfor transparent, 1 pc
4	SMQA4WH	smartquick A4, 1 pc



zip trolley



real bianco

MADE IN EU design by KD



IT elegante il nostro real bianco – la variante con stile del nostro zip originale, il più alto in qualità, con nuove ulteriori interessanti caratteristiche: 4 tasche portacataloghi in policarbonato trasparente, con alette laterali per evitare la caduta dei fogli singoli, compongono un espositore stabile e sicuro. le barre laterali ergonomiche in metallo anodizzato e la composizione a forma di scala consentono di prendere i cataloghi comodamente, inoltre, lo zip divider dà la possibilità di dividere la tasca A4 in 2 formati A6, di particolare interesse è il pixquick A4 montato sul pannello frontale, che rende possibile la personalizzazione dell'espositore. il brillante design del pixquick fa presentare le sue personalizzazioni a prova di polvere e senza cornici laterali. real bianco: il colore tanto di moda ora disponibile anche per la sua comunicazione visiva.

DE elegant in weiss der real bianco - die stilvolle variante unseres original zip in top ausführung mit praktischen extras: 4 A4 polycarbonat spritzguss taschen mit einzelblattkippschutz entfalten sich im handumdrehen zum standfesten display. mit zip divider machen sie aus einem A4 zwei A6 fächer. stufenförmige staffelung und ergonomisch geformte seitenstreben aus mattweiss pulverlackbeschichtetem metall gewährleisten perfekte entnahme von prospektmaterial. besonderer clou ist die vormontierte pixquick A4 tasche am frontpaneel. damit personalisieren sie real bianco schnell und immer passend zum anlass. das clevere pixquick design präsentiert ihren druck ohne rahmen und staubgeschützt. real bianco: edles weiss, die trendfarbe jetzt auch für ihre visuelle kommunikation.

EN elegant in white is the real bianco - the stylish version of our top quality original zip with many extras: 4 die-cast polycarbonate brochure pockets which unfold in no time at all into an elegant display, staggered arrangement and the ergonomically curved metal side braces guarantee easy access to the printed material. all metal parts are powder coated in matt white colour, the mounted A4 poster pocket pixquick is especially convenient, in the blink of an eye your real zip is customized for any occasion, the clever pixquick design presents your print, in a frameless and dust proof way. real bianco: elegant white - the trend colour now available also for your visual communication.



A real bianco

- 1 RZ4WE real bianco 4 pockets, white metal parts, 1pc
- 2 DNZIP02 zip divider restyle, set 2pcs



personalizzazione semplice e veloce: stampare la grafica ed inserirla nel pixquick.

personalisierung einfach und schnell: grafik ausdrucken, einlegen, fertig!

quick and easy customizing: print your graphics, insert in pixquick, ready!



zip divider restyle: restyling del divisore in acrilico trasparente, per 2 A6 verticali

zip divider restyle: transparentes acryl, unterteiler für prospekttasche in 2 A6 fächer

zip divider restyle: transparent acrylic, divides the A4 brochure pocket into 2 A6 trays



real bianco

MADE IN EU design by KD



IT la famiglia zip è cresciuta: accanto all'intramontabile real bianco a 4 tasche, la nostra linea rivoluzionaria zip dispone di tre nuovi modelli. a seconda delle sue esigenze, potrà scegliere tra le nuove varianti a 2, 3 e a 6 tasche portacataloghi. le tasche sono in formato A4 e dispongono di un sistema anticaduta dei fogli, come tutti i nostri sistemi zip, anche i tre nuovi modelli sono pieghevoli, quindi di semplice apertura e chiusura. il pannello frontale resta vuoto, ma può essere personalizzato con l'acquisto delle nostre soluzioni linfor e pixquick.

DE zuwachs für die real-bianco-familie: neben dem real bianco mit 4 ablagen, gibt es nun drei weitere stilvolle varianten aus unserer revolutionären prospekt-ständerlinie zip. je nach bedarf, können sie zwischen der variante aus 2, 3 oder 6 A4 prospekttaschen mit einzelblattkippschutz wählen. wie bei all unseren zip-systemen, können auch die neuen modelle im handumdrehen aufgestellt und wieder kompakt zusammengeklappt werden. entscheiden sie selbst, ob sie die frontfläche frei lassen, bekleben oder mit unseren lösungen linfor oder pixquick personalisieren wollen.

EN the zip family has added three new members: besides the version with 4 brochure pockets, the legendary zip line has extended to three new stylish variants. depending on your needs, you can choose between the version with 2, 3 or 6 A4 brochure pockets. just like all our zip systems, the three new models can be unfolded in no time at all and, after use, you can fold them together compactly. you decide whether to leave this area empty, to personalize it quick and simple by foiling something onto it or by using our practical solutions linfor or pixquick.

A real bianco

1	RZ2WE	real bianco 2 pockets, white metal parts, 1pc
2	RZ3WE	real bianco 3 pockets, white metal parts, 1pc
3	RBZIP6A4WE	real bianco 6 pockets, white metal parts, 1pc
4	LINFORA4WH	linfor white A4, 1pc
5	LINFORA3WH	linfor white A3, 1pc
6	PQA4	pixquick A4, 1pc
7	PQA3	pixquick A3, 1pc



information

2, 3 o 6 tasche portacataloghi formato A4 in policarbonato antiurto, base in mdf laccata color bianco, parti laterali e pannello frontale in metallo verniciato a polvere color bianco.

2, 3 oder 6 prospekttaschen A4 aus schlagfestem polycarbonat, basis mattweiß lackiertes mdf, seitenstreben und frontpanel mattweißes, pulverlackbeschichtetes metall

2, 3 or 6 brochure pockets for A4 format made of shock-resistant polycarbonate, matt white varnished mdf base, side parts and front panel in powder coated matt white metal.

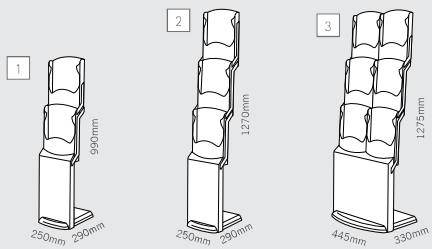

optional supports



velocemente personalizzabile con i linfor bianco o pixquick. schnell und einfach personalisieren mit linfor weiß oder pixquick. quick and easy customizing with linfor white or pixquick.





real steel

MADE IN EU design by KD



IT particolarmente robusto ma comunque elegante, ecco il nostro espositore portadepliant real steel. una struttura di colore nero e acciaio inox di alta qualità che in un batter d'occhio diventa uno stabile espositore porta cataloghi. tutte e quattro le tasche porta cataloghi sono realizzate in acciaio spazzolato. lo speciale rivestimento è a prova di impronte. sul pannello frontale è presente una tasca porta informazioni tramite la quale è possibile personalizzare in qualsiasi momento il suo real steel con una semplice stampa in formato A4. sulla base è stata aggiunta una protezione in abs, per mantenere questo articolo in sicurezza al momento del montaggio. il nostro real steel è una combinazione vincente tra acciaio inox e il colore nero tanto di moda.

DE besonders robust und doch elegant ist unser faltbares prospektdisplay real steel. die kombination aus schwarzer struktur und hochwertigem edelstahl faltet sich im handumdrehen zu einem stabilen prospektpräsentier. alle 4 prospekttaschen sind aus gebürstetem edelstahl. dank der speziellen beschichtung hinterlassen finger und hände auf dem edelstahl kaum sichtbare spuren. am frontpaneel finden sie eine info-tasche. hier können sie mit einem A4-druck ihren real steel jederzeit passend personalisieren. auf der bodenplatte haben wir einen trittschutz aus abs angebracht, so bleibt dieser bereich beim aufstellen geschützt. unser real steel ist eine gelungene kombination in modischem schwarz und trendigem edelstahl.

EN our foldable brochure display real steel is particularly robust yet elegant. the combination of a black structure and high-grade stainless steel folds up in no time at all to a stable brochure holder. all 4 brochure pockets are made of brushed stainless steel with a special coating that makes them almost fingerprint proof. on the front panel you will find an information pocket. with an A4 print you can easily customize the real steel. on the floor plate we put a step-on-protection in abs, keeping this part protected when you set up the display. our real steel is a successful combination in modern black and trendy steel.

information

4 tasche A4 in acciaio inox spazzolato, sistema di rivestimento anti impronta, tasca porta informazione frontale in A4, rivestimento in metallo color nero, base rivestita in color nero satinato, mdf

4 A4 taschen edelstahl gebürstet, fingerabdruck-resistente spezialbeschichtung, frontpaneel infotasche A4, metall schwarz pulverlackbeschichtet, bodenplatte mattschwarz beschichtet, pressspan

4 A4 pockets brushed stainless steel with fingerprint proof coating, front panel with information pocket A4, metal black powder coated, floor plate matt black coated press board

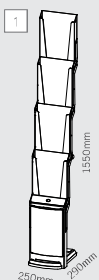

A real steel

1 RZ4SZ real steel 4 pockets, 1pc



sicuro e sempre pulito: base con protezione in abs per una maggiore sicurezza durante montaggio e smontaggio del prodotto.

sicher und sauber: trittschutz aus abs für schutz der basis bei auf- und abbau.

safe and clean: step on protection made of abs to protect the floor plate during set up.



personalizzazione semplice e veloce: stampare la grafica ed inserirla nel pixquick.

personalisierung einfach und schnell: grafik ausdrucken, einlegen, fertig!

quick and easy customizing: print your graphics, insert in pixquick, ready!

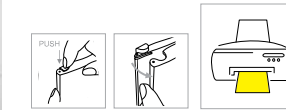



realbig

MADE IN EU design by KD



zip divider restyle: restyling del divisore in acrilico trasparente, per 2 A6 verticali

zip divider restyle: transparentes acryl, unterteiler für prospekttasche in 2 A6 fächer

zip divider restyle: transparent acrylic, divides the A4 brochure pocket into 2 A6 trays

IT ha bisogno di presentare molto materiale informativo dovendosi comunque muovere con facilità? realbig è la soluzione, grazie alle sue 8 tasche portacataloghi DIN A4 stampate ad iniezione in policarbonato antiurto e resistente ai raggi UV. Le tasche sono dotate delle pratiche alette laterali che prevengono la caduta in avanti dei fogli singoli, mentre la base dona stabilità all'espositore. Le barre laterali ergonomiche in alluminio anodizzato e la composizione a forma di scala consentono di prendere i cataloghi comodamente. Inoltre, lo zip divider le dà la possibilità di dividere la tasca A4 in 2 formati A6.

DE umfangreiches material präsentieren und doch mobil sein? realbig ist ihre lö-sung. sie erhalten acht bruchfeste uv-beständige polycarbonat spritzgusstaschen für DIN A4. jede tasche mit dem praktischen, seitlichen einzelblattkipp-schutz. eine grosse basis gibt sicheren stand. durch die stufenförmige staffelung und ergonomisch geformten seitenstreben ist die entnahme aus jeder der acht prospektaschen ganz bequem. mit dem zip divider als zubehör teilen sie die A4 taschen durch ein-schub ganz einfach und erhalten 2 A6 fächer.

EN presenting lots of material with a portable display? realbig is the answer. you get eight shock- and uv-resistant brochure trays for DIN A4 format made of die-cast polycarbonate. one solid base secures the steady stand. the staggered arrangement and the ergonomically curved side braces makes access to all of the eight brochure hdders comfortable and easy. with the zip divider from our accessory assortment you can easily make a tray for 2 A6 out of the A4 pocket.

information

8 tasche porta depliant in policarbonato antiurto, base mdf laccata color argento satinato, parti laterali in alluminio anodizzato

8 prospektaschen DIN A4 aus schlagfestem polycarbonat, basis silbermatt lackiertes mdf, seitenstreben silbereloxiertes aluminium.

8 brochure pockets for DIN A4 format made of shock-resistant polycarbonate, silver varnished mdf base, side parts made of silver anodized aluminium.

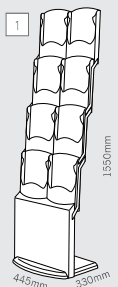

A	realbig									
1	RBZIP155AA	realbig silver base, 1pc								
2	DNZIP02	zip divider restyle, set 2pcs								



zip bag

A5

1
smartzip for A5 brochures



smartzip

MADE IN EU design by KD



veloce, pratico, geniale: stampare il banner, inserirlo nel profilo superiore, tensionarlo e regolare il profilo inferiore in base alla sua lunghezza.

schnell und genial: banner bedrucken, im klemmprofil fixieren, spannen und das untere profil entsprechend fixieren.

quick, easy, smart: print your banner, mount in the extrusion, pull taught and fix the lower bar according to the banner length.

IT smartzip, con le sue 4 tasche portadepliant in formato A5 è maneggevole e pratico. Le tasche sono in acrilico trasparente ed antiurto, le parti laterali e i profili per il banner in alluminio anodizzato, completa l'opera la base in mdf laccata in argento satinato, particolarmente geniale è la possibilità di personalizzazione grazie ad una stampa digitale: il banner si inserisce nel profilo bannerblock, si tensiona, si regola il profilo inferiore in base alla sua lunghezza ed il gioco è fatto, la carta per la stampa del banner è inclusa, ma si può utilizzare qualsiasi altro materiale di spessore compreso tra 0,2 e 0,7 mm, per una personalissima versione di smart.

DE handlich, praktisch und mobil ist der smartzip mit seinen vier prospekttaschen für A5 format, die prospekttaschen sind aus schlagfestem, transparentem acryl, die seitenstreben und die bannerprofile aus silber eloxiertem aluminium, dazu passend die silbermatt lackierte mdf basis, besonders smart zeigt sich auch die personalisierung mit druck, einfach die ausgedruckte grafik im bannerblock klemmprofil befestigen, spannen, fertig, wir liefern passendes papier mit selbstverständlich können sie auch alle anderen materialien in den stärke 0,2-0,7mm bedrucken und verwenden.

EN handy, smart and mobile is smartzip with its four brochure pockets in A5 format. the pockets are made of shock-resistant acrylic, the lateral parts and the banner extrusions are made of silver anodized aluminium, matching with this the mdf base is silver matt coated, especially smart is the customizability with print, just mount the print into the extrusion, pull it taught and that's it, paper with matching size is included. but you can certainly use any other material with thicknesses between 0,2mm and 0,7mm for customizing your smart.

information

4 tasche portadepliant formato DIN A5 in acrilico antiurto, base in mdf laccata in argento satinato, parti laterali e profili bannerblock in alluminio anodizzato, carta per la stampa del banner inclusa.

4 prospekttaschen für DIN A5 format, schlagfestes acryl, basis silbermatt lackiertes mdf, seitenstreben und bannerblock aus silbereloxiertem aluminium, papier zum bedrucken für banner inklusive.

4 brochure trays for DIN A5 format made of shock-resistant acrylic, matt silver varnished mdf base, side parts and banner block made of silver anodized aluminium, paper for printing of banner incl.

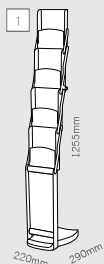

A smartzip

1 SMART125AA smartzip, 1pc

fixtable

MADE IN EU design by KD



praticità: il retro del pannello frontale diventa una terza tasca porta informazioni, cover in acrilico.

praktisch: zusätzliche dritte tasche auf der rückseite für printmaterial mit acrylglas-abdeckung.

convenient: additional third brochure tray on rear side with cover made of acrylic glass.

IT fixtable è la versione economica della nostra combinazione tra lo zip pieghevole e un tavolino per presentazioni. il tabletop in argento metallizzato le offre lo spazio per documentazioni in formato DIN A4 una accanto all'altra. In un batter d'occhio potrà utilizzare così la sua isola di contatto multifunzionale. l'espositore è formato da 2 tasche portacataloghi sul davanti e da una tasca sul retro, dietro al pannello frontale, per il suo materiale che non deve essere a diretto contatto con il pubblico. fixtable è ottimo come punto di informazione mobile per la rete vendita, per le fiere o per qualsiasi presentazione di informazioni o prodotti.

DE fixtable ist die ökonomische variante der kombination aus tragbarem zip und einem präsentationstisch, die silbermetall lackierte tabletop hat platz für zwei DIN A4 unterlagen nebeneinander, im handumdrehen haben sie ihre multifunktionale kontaktinsel aufgestellt. 2 prospekttaschen vorne für material zum mitnehmen, die rückseitige tasche kann für vertrauliche handouts genutzt werden, fixtable bietet sich als mobiles infodesk im aussendienst sowie auf messen oder als produkt- und infodisplay für präsentationen aller art.

EN fixtable is the economic version of the combination between a table and our portable zip brochure rack, the silver metallic varnished tabletop has space for 2 DIN A4 beneath, in no time you unfold the fixtable to a multifunctional counter, you find 2 brochure pockets on the front for take-away folders, while the rear tray can be used for more confidential handouts. fixtable is best as mobile infodesk in the field, on exhibitions or as a product- and information display for presentations of all kinds.

information

fixtable: tavolino e base mdf color argento parti laterali e pannello frontale in acciaio laccato color argento metallizzato

fixtable: top und basis silber lackiertes mdf, seitenstreben und frontpaneel aus stahl, silbermetall pulverbeschichtet.

fixtable: table top and base silver matt mdf, sideparts and front panel made of silver metallic powder coated steel

eleganza: tavolino laccato in argento metallizzato.

elegant: silbermetall lackiertes tabletop.

elegant: silver metallic coated table top

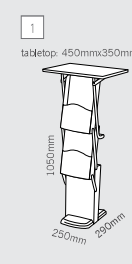

A fixtable

1 FTZ105AA fixtable silver base, 1pc



zip dividers

MADE IN EU design by KD



ZIP divider, divisore in acrilico trasparente per due depliant DIN A6 verticali: sistemati uno di fianco all'altro

ZIP divider, nachrüstbare unterteilung aus farblosem acrylglas für 2 prospekte DIN A6-lang nebeneinander

ZIP divider, transparent acrylic divider for two brochures DIN A6 which can be arranged side-by-side

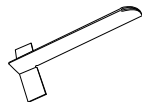

zip divider restyle: divisore in acrilico trasparente per due depliant DIN A6 verticali: sistemati uno di fianco all'altro

zip divider restyle: transparentes acryl, unterteiler für prospekttasche in 2 A6 fächer

zip divider restyle: transparent acrylic, divides the A4 brochure pocket into 2 A6 trays

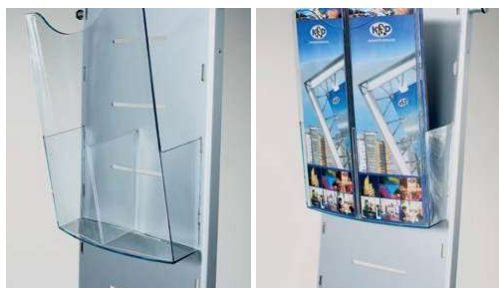
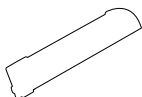

magic divider acrilico trasparente, divide la tasca A4 (MZIP300BRPC) in 2 scomparti per A6, si inserisce nella tasca

magic divider transparentes acrylglas, unterteilt durch ein Schub die prospekttasche A4 (MZIP-300BRPC) in 2 A6 fächer

magic divider transparent acrylic, put into the A4 brochure tray MZIP300BRPC and get a place for 2 A6

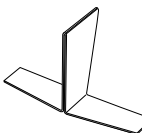

A zip dividers

1	DZIP01*	zip divider, set 2pcs
2	DNZIP02	zip divider restyle, set 2pcs
3	MDIV02	magic divider, set 2pcs

t-tray	MZIP300BRPC	solidzip	sailzip	smart zip	light zip	real zip	real bianco	zip media	real big	show zip	fixtable
●	●	●	●	●	●	●	●	●	●	●	●

* fino ad esaurimento scorte | solange vorrat reicht | while stock last

zip bag

MADE IN CHINA design by KD



information

borsa per il trasporto in resistente tessuto di nylon con cinghia regolabile per il trasporto a spalla, cerniera lampo a 2 direzioni.

transporttasche aus reißfestem nylongewebe mit einstellbarem schultertragegurt, 2 wege reißverschluss.

transport bag of tear-resistant nylon with adjustable shoulder strap, 2 way zipping system.



zip trolleys

MADE IN CHINA design by KD



information

valigia-trolley semirigida per il trasporto, in poliestere con contorno rinforzato, dotata di due maniglie, una retrattile e una normale, con tasca esterna, chiusura con cerniera lampo a due direzioni, cinghie all'interno.

rollkoffer für den transport aus polyestergewebe, leichtschale, stabiler rahmen, integrierter teleskopgriff, extra tragegriff, aussentasche, zwei-wege reissverschluss, mit packgurten.

transport trolley case, polyester, softcase, stout frame, integrated telescopic handle, extra handle, outer pocket, two-way zipper, straps inside.

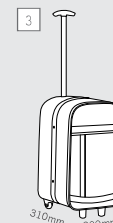

A zip bags, trolleys, cases

1	TZIPO1	transport bag small, 1pc
2	TZIPO3	transport bag big, 1pc
3	ZIPTROLLEY	ziprolley, 1pc

lightzip	realzip	smartzip	realbig	fixtable	zipmedia
●	●	●	●	●	●



double

MADE IN EU design by KD



IT grazie a double potrai usufruire di tutti i vantaggi della linea magic. in modo semplice e veloce il suo espositore bifacciale, in alluminio anodizzato, è pronto all'uso. l'intera gamma di accessori della linea magic è a sua completa disposizione per la configurazione dei due pannelli di alluminio. double magic diventa così espositore per cataloghi oppure per riviste e giornali, portaoggetti e porta cd, oppure una combinazione di tutte queste cose insieme, a sua scelta. gli accessori, infatti, sono facilmente intercambiabili così potrai realizzare ogni sua esigenza espositiva.

DE nutzen sie mit double alle magic vorteile. schnell und einfach stellen sie das zweiteilige display aus eloxiertem aluminium zusammen. das gesamte zubehör programm der magic serie steht ihnen jetzt für die gestaltung der beiden paneelseiten zur verfügung. freistehend wird der double magic zum prospekt- oder zeitschriftenständer, wegweiser, produktdisplay oder einer kombination aus allem zugleich. einfach ein- und umgehängt sind alle elemente schnell untereinander ausgetauscht. ihre anforderungen setzen sie mit double jederzeit um.

EN double all the advantages of magic zip with the double. set up easily the two-piece display made of anodized aluminium. now choose from of the whole magic assortment to design the two sides according to your needs. the freestanding double magic becomes a brochure shelf, a magazine rack, a product display or a combination of all of these together. the attaching system allows you to change all the elements quickly. whatever you need, with double you can realize it anytime.

information

DOUBLE: base e pannello in alluminio anodizzato, base con vite a testa zigrinata, pannello con fessature laterali.

DOUBLE: basis und panel aus silber eloxiertem aluminium, basis mit rändelschraube, panel mit austräsungen.

DOUBLE: base and panel made of silver anodized aluminium, hand screw the base closed, panel with notches.

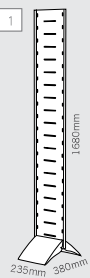

A double

1	MDZIP1680	double, 1pc	63 78
2	MZIP300EAL*	aluminium tray, 1pc	
3	MZIP300EPL*	acrylic tray, 1pc	
4	MZIP300BRPC	brochure tray A4, 1pc	
5	PQMA4	pixquick magic A4, 1pc	
6	PQMA5*	pixquick magic A5, 1pc	

* fino ad esaurimento scorte | solange vorrat reicht | while stock last



1 + 8x 4 + 2 5



ripiano leggermente inclinato in alluminio anodizzato color argento, compatibile con tutti gli espositori magic, DIN A4, bordo frontale alto 38mm.

ablage, leicht geneigt, silbermatt eloxiertes aluminium, kompatibel mit allen magic zips, DIN A4, frontaler rand 38mm.

tray, slightly sloped, silver anodized aluminium, matching with all magic zips, DIN A4, 38mm frontal edge.

ripiano leggermente inclinato in acrilico trasparente e antiriflesso, compatibile con tutti gli espositori magic, DIN A4, bordo frontale alto 38mm.

ablage, leicht geneigt, schlagfestes, transparentes acrylglas, kompatibel mit allen magic zips, DIN A4, frontaler rand 38mm.

tray, slightly sloped, shock-resistant transparent acrylic, matching with all magic zips, DIN A4, 38mm frontal edge.

tasca portadepliant da agganciare sull'espositore in policarbonato antiriflesso e resistente ai raggi UV, per formato DIN A4.

prospektschale zum einhängen, aus uv-resistentem, bruchsickehem polycarbonat, für DIN A4 format.

brochure holder to be attached, uv-resistant, shock-proof polycarbonate, for DIN A4 size.

pixquick magic A4 verticale: policarbonato trasparente con supporti laterali in alluminio anodizzato color argento.

pixquick magic A4 vertikal: transparentes polycarbonat, mit silber eloxierten aluminium halterungen.

pixquick magic A4 vertical: transparent polycarbonate, with silver anodized aluminium supports.



pixquick magic A5 orizzontale: policarbonato trasparente con supporti laterali in alluminio anodizzato color argento.

pixquick magic A5 horizontal: transparentes polycarbonat, mit silber eloxierten aluminium halterungen.

pixquick magic A5 horizontal: transparent polycarbonate, with silver anodized aluminium supports.





1
magic zip



MZIP160AB

MZIP160AA

magic zip

MADE IN EU design by KD



IT l'idea è tanto semplice quanto geniale. una struttura di 160cm in lamiera di alluminio anodizzato con fessure orizzontali e verticali fresate, fissata su una base in MDF color argento satinato o prevista di piedini di appoggio stampati in alluminio. questo è il punto di partenza per una quantità infinita di variazioni e di utilizzazioni, realizzabili grazie a tutta una serie di accessori ed elementi combinabili ed intercambiabili a piacere. magic zip come portariviste, portadepliant, porta CD oppure come display mobile ed individuale per il punto vendita, ideale per il produttore di articoli di marca – lo vedrebbe per esempio come espositore di scarpe da ginnastica? per articoli di cosmetica? per occhiali? o forse ancora meglio come lampada da terra con ripiani per libri ed oggetti del genere, con un porta CD ed un portariviste per l'angolino relax di casa?

DE die idee ist einfach wie brillant. ein 160cm hohes, silber eloxiertes aluminiumblech mit ausgefrähten vertikalen und horizontalen lochreihen, befestigt auf einer silberlackierten bodenplatte aus MDF oder mit fußstützen aus aluminiumspritzguss. dies ist die ausgangsbasis für unzählige anwendungs- und variationsmöglichkeiten, welche sich aus einer vielzahl von einhängeelementen aus verschiedenen materialien ergeben, die untereinander kombiniert werden können. magic zip als zeitschriftenständer, als prospektständer, als CD-ständer oder als mobiles, freistehendes und individuelles POS display für den markenartikelhersteller. wie wäre es zum beispiel mit sportschuhen, kosmetikprodukten, oder brillen? oder als stehlampe mit bücher- und sonstigen ablagen, CD-halterung und zeitungskorb für die relax-ecke zuhause?

EN simply a brilliant idea. moulded series of horizontal and vertical holes on a silver anodized aluminium board mounted on a silver lacquered base of medium density fiber (MDF) or on feet made of aluminium die-cast. a starting point for countless applications. why countless? the multitude of combinations between the many different hanging elements and their many different materials is simply amazing. newspaper stand, brochure holder, cd-rack, individual POS-display for the newest brand-article on the market. sunglasses? perfumes? cosmetics, jewellery? or simply as bookshelf or rack for your family pictures next to your favourite chair in your home?

A magic zip

1	MZIP160AB	magic zip feet, 1pc	
2	MZIP160AA	magic zip silver base, 1pc	



praticità supporto in alluminio, con O-ring di plastica, per borse, portabadge o appendiabiti.

praktisch: je seite ein halter mit gumming, für taschen, lanyards oder garderobe

convenient: aluminium support on each side with rubber ring, for bags, lanyards or your coats



126

accessories



1 + 1x 13 + 1x 14 + 1x 15 + 2x 9

information

lamiera di alluminio anodizzato color argento con fresature, con piedini d'appoggio stampati in alluminio o con base in mdf verniciata color argento.

eloxiertes aluminium mit fräsungen, fußstützen aus schlagfestem aluminiumspritzguss oder silbermatt lackierte mdf-basis

silver anodized aluminium structure with notches, feet made of shock-resistant aluminium die-cast or matt silver varnished mdf base.

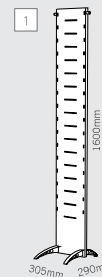

affascinare grazie ai giochi di luce! è ciò che le offre magic light. la luce posteriore può essere montata sulla struttura magic in qualsiasi momento. in questo modo potrà creare atmosfera e magici giochi di luce grazie al suo magic!

mit licht faszinieren, das bietet ihnen magic light. die leuchte kann jederzeit auf die magic zip struktur montiert werden. so können sie ihren magic aufrüsten und tolle effekte zaubern.

fascinate with light! magic light can be mounted anytime on your magic zip. so tune up your magic anytime and create atmospheric and fascinating effects.

1 3
magic zip with magic light



magic zip – il trasformista ...poi come portaoggetti con ripiani in acrilico color vetro ...

magic zip - der verwandlungskünstler ...ein anderes mal mit acrylglasbord.

magic zip - an elegant solution with shelf made of acrylic glass.

magic accessories

MADE IN EU design by KD



A magic zip

1	MZIP160AB	magic zip feet, 1pc	
2	MZIP160AA	magic zip silver base, 1pc	
3	MZIP138LA*	magic light, 1pc	
4	PQMA4	pixquick magic A4, 1pc	
5	PQMA5*	pixquick magic A5, 1pc	
6	MZIP300EAL*	aluminium tray, 1pc	
7	MZIP300EPL*	transparent acrylic tray, 1pc	
8	MZIP300BRPC	brochure tray A4, 1pc	
9	MZIP300CGG*	magic crowner, 1 pc	
10	MDIV02	magic divider, set 2pcs	
11	MZIP158SRB*	metal shelf, 1 pc	
12	MZIP158SRGG	acrylic glass-green shelf, 1pc	
13	MZIP15CRFI*	cd-rack, 1pc	
14	MZIP6PRFI	magazine rack, 1pc	58,00€
15	MVELOAT01	1set with 4magic spacers, 2o-rings	

* fino ad esaurimento scorte | solange vorrat reicht | while stock last

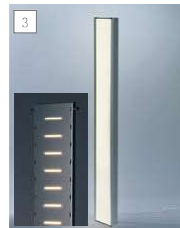

magic light. illuminazione posteriore con tubo luminescente da 38W, facile da montare, altezza 1380mm.

magic light, beleuchtung mit 38W leuchtstoffröhre, einfach auf der rückseite zu montieren, höhe 1380mm.

magic light, powered by a 38W fluorescent tube, easy to mount on the rear side, height 1380mm.



pixquick magic A4 verticale e A5 orizzontale: policarbonato trasparente con supporti laterali in alluminio anodizzato color argento.

pixquick magic A4 vertikal und A5 horizontal: transparentes polycarbonat, mit silber eloxierten aluminium halterungen.

pixquick magic A4 vertical and A5 horizontal: transparent polycarbonate, with silver anodized aluminium supports



ripiano leggermente inclinato in alluminio anodizzato color argento o in acrilico trasparente e antiriflesso, compatibile con tutti gli espositori magic, DIN A4, bordo frontale alto 38mm.

ablage, leicht geneigt, silbermatt eloxiertes aluminium oder schlagfestes acrylglas kompatibel mit allen magic zips, DIN A4, frontaler rand 38mm.

tray, slightly sloped, silver anodized aluminium or shock-resistant transparent acrylic, matching with all magic zips, DIN A4, 38mm frontal edge



tasca portadepliant da agganciare sull'espositore, in policarbonato antiriflesso e resistente ai raggi UV, per formato DIN A4

prospektschale zum einhängen, aus uv-resistentem, schlagfestem polycarbonat, für DIN A4 format

brochure holder to hook on, uv- and shock-resistant polycarbonate, for DIN A4 size



inserto crowner per magic, portaposter in formato DIN A4, acrilico color vetro.

crowner aufsatzschild, posterhalter für DIN A4, glasgrünes acrylglas.

top crowner, post pocket for format DIN A4 made of glassgreen acrylic.



divider acrilico trasparente, divide la tasca MZIP-300BRPC in 2 A6.

divider transparentes acryl, teilt MZIP300BRPC in 2 A6.

divider transparent acrylic, divides MZIP-300BRPC into 2 A6.



ripiano in lamiera di metallo verniciato a polvere, 158mmx218mm (pxb).

ablage aus metall, silbermetallisch pulverbeschichtet, 158mmx218mm (txb).

metal tray, silvermetallic powder coated, 158mmx218mm (dxw).



ripiano in acrilico color vetro, agganci laterali in alluminio anodizzato color argento, 158mmx218mm (pxb).

ablage aus acrylglas glasgrün, seitliche halterungen silber eloxiertes aluminium, 158mmx218mm (txb).

acrylic glass tray, sideparts anodized aluminium, 158mmx218mm (dxw).



porta CD per 15 CD, 125mmx225mm (pxb) in metallo verniciato a polvere.

CD-halter für 15 cd, 125mmx225mm (txb) metall silbermetallisch pulverbeschichtet.

rack for 15 cd, 125mmx225mm (dxw) silvermetallic powder coated.

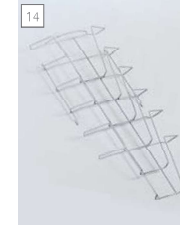

sostegno in metallo verniciato a polvere per esporre fino a 6 riviste, 720x260x90mm (hxhxp).

zeitschriftenhalter mit 6 körben, pulverbeschichtetes metall, 720x260x90mm (hxhxt).

magazin rack with 6 baskets, metal powder coated, 720x260x90mm (hxwxd).



magic distanziatori con o-ring: 4 distanziatori in alluminio anodizzato, 2 o-ring in silicone trasparente.

magic distanzhalter mit o-ring: 4 halter silber eloxiertes aluminium, 2 o-ringe aus transparentem silikon.

magic spacers with o-ring: 4 spacers silver anodized aluminium, 2 o-rings made of transparent silicone





magic brochure rack

MADE IN EU design by KD

IT magic zip – portacataloghi: le 5 tasche singole realizzate in policarbonato antiurto vengono agganciate sulle fresature verticali ai lati della struttura e offrono tantissimo spazio per cataloghi, depliant e brochure informative in formato DIN A4.

DE magic zip - in seiner verwandlung als prospektständer, fünf einzelne, in die vertikalen, seitlichen ausfräsungen sicher eingehängte prospektschalen aus schlagfestem polycarbonat bieten viel platz für kataloge und prospekte im DIN A4 format.

EN magic zip - brochure rack, perfect and professional: the brochure rack magic zip holds five single brochure pockets (DIN A4) made of shock-resistant polycarbonate, safely attached to the aluminium panel.

A magic brochure rack

1	MZIP160AB	magic zip feet, 1pc
2	MZIP160AA	magic zip silver base, 1pc
3	MZIP300BRPC	brochure tray A4, 1pc



magic flyer rack

MADE IN EU design by KD

IT ideale per fogli singoli o depliant di piccole dimensioni, magic zip si trasforma in un display per flyers grazie ai distanziatori in alluminio anodizzato, avvitare i distanziatori e aggiungere gli elastici in silicone trasparente durevole e resistente ai raggi UV: il suo nuovo display dal look accattivante è pronto all'uso.

DE speziell für einzelblätter oder flyer eignet sich magic zip als flyer rack mit den silber eloxierten aluminium haltern: einschrauben, uv-resistente und langlebige silikon o-ringe befestigen, fertig ist das etwas andere prospekt-display.

EN especially recommended for single sheets and flyers; magic zip in combination with the silver anodized aluminium spacers: just screw on, mount the long-lasting, uv-resistant silicone o-rings and you get a brochure rack with a very special look.

A magic flyer rack

4	MZIP160AB	magic zip feet, 1pc
5	MZIP160AA	magic zip silver base, 1pc
6	MVELOATO1	1set with 4magic spacers, 2o-rings



turnpoint

MADE IN EU quality control by KD



IT turnpoint è un espositore da terra autoportante che si può usare da entrambi i lati. le fessature sono state ideate proprio per agganciarvi velocemente e semplicemente le tasche dacapo, nei formati A4, A5 e A6. turnpoint gira a 360° in entrambi i sensi e per questo motivo è doppiamente flessibile.

DE turnpoint ist ein stabiles freistehendes bodendisplay, das sie doppelseitig bestücken können. die fräsungen sind dabei so konzipiert, dass sie dacapo container in größe A4, A5 und A6 schnell und einfach einhängen können. turnpoint lässt sich frei in beide richtungen drehen und ist damit doppelt flexibel.

EN turnpoint is a stable, free standing, double-sided floor display for displaying your catalogues. the slots which we have made match with all of the dacapo brochure pockets. the A4, A5 and A6 sized containers are quickly and easily inserted. turnpoint is freely rotatable in both directions, providing you double flexibility in your brochure presentation.

information

metallo verniciato a polvere in colore nero, fessature adatte per agganciare tutte le tasche dacapo.

schwarz pulverlackbeschichtetes metall, mit fräsungen passend für alle dacapo prospekttaschen zum einhängen.

black powder coated metal, matching slots for all attachable dacapo poster pockets

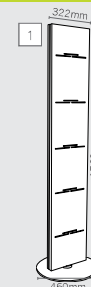

contenitori da appendere in formato DIN A4, DIN A5 o DIN A6, in polistirolo.

box zum einhängen für DIN A4, DIN A5 oder DIN A6 format, aus ps-polystyrol.

brochure pocket attachable for DIN A4, DIN A5 or DIN A6 format, made of polystyrene.

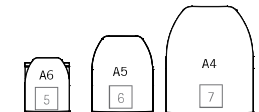

A turnpoint

1	TUP1760SZ	turnpoint, 1pc
2	DCTA6	dacapo brochure pocket A6, 1pc
3	DCTA5	dacapo brochure pocket A5, 1pc
4	DCTA4	da capo brochure pocket A4, 1pc



dacapo ipoint

MADE IN EU design by KD



IT design semplice e moderno da ora anche flessibile: è sufficiente agganciare le tasche trasparenti al display bifacciale nero opaco con cornice argentata e il gioco è fatto, sono disponibili tasche in diversi formati: A4, A5 e A6.

DE schlanke, modernes design und äusserst flexibel: in das doppelseitige schwarzmatte display mit den silbermatten seiten werden die transparenten container einfach ein-, aus- und umgehängt. container für format A4, A5 und A6 stehen für sie zur auswahl bereit.

EN lean and modern design yet very flexible: simply insert into the double side black matt display with silver matt frame the transparent containers, we have containers in A4, A5 and A6 sizes for you to choose from.

information

display da terra bifacciale autoportante, cornice in alluminio anodizzato color argento, pannello in alu bond color nero, base color nero opaco

doppelseitiges freistehendes bodendisplay: silbereloxierter alu-rahmen, schwarzes alu-verbundpaneel, schwarz-matte basis

double-side freestanding floordisplay: silver anodized aluminium frame, black aluminium composite panel, black matt base.

contenitori da appendere in formato DIN A4, DIN A5 o DIN A6, in polistirolo

box zum einhängen für DIN A4, DIN A5 oder DIN A6 format, aus ps-polystyrol

container attachable for DIN A4, DIN A5 or DIN A6 format, made of polystyrene

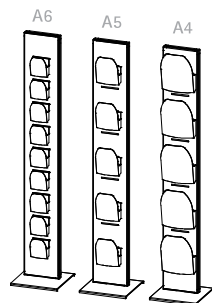
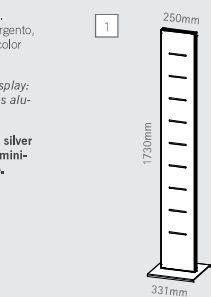

A dacapo ipoint

1	DCI1730250SZ	dacapo ipoint black, 1pc	
2	DCTA6	brochure pocket A6, 1pc	
3	DCTA5	brochure pocket A5, 1pc	
4	DCTA4	brochure pocket A4, 1pc	



1 + 5x 4



dacapo twist

MADE IN EU design by KD



girevole in entrambi i sensi
frei drehbar in beide richtungen
freely rotatable in both directions

IT semplicemente flessibile: è il nostro dacapo twist, girevole in senso orario e anti orario, sull'espositore bifacciale color nero opaco, con la cornice laterale argentata, si agganciano e sganciano molto semplicemente le tasche disponibili nei formati A4, A5 e A6, disponibili a seconda delle sue necessità.

DE rundum flexibel: geräuschlos, frei drehbar in beide richtungen ist unser dacapo twist. in das doppelseitige schwarzmatte display mit den silbermatten seiten werden die transparenten container einfach ein-, aus- und umgehängt. container der formate A4, A5 und A6 stehen zu ihrer auswahl bereit.

EN all-round flexible: soundlessly and freely rotatable in both directions is our dacapo twist. simply insert into the double side black matt display with silver matt frame the transparent containers. we provide you with containers in A4, A5 and A6 size.

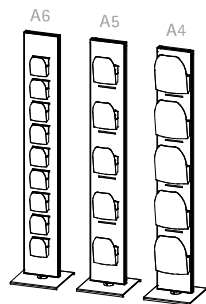

information

espositore da terra autoportante girevole bifacciale. cornice in alluminio anodizzato color argento, pannello composito in alluminio color nero, base nera opaca.

doppelseitiges frei drehbares bodensdisplay: silbereloxierter alu-rahmen, schwarzes alu-verbundpaneel, schwarz-matte basis

double-side freestanding and freely rotatable floor display: silver anodized aluminium frame, black aluminium composite panel, black matt base.

contenitori da appendere in formato DIN A4, DIN A5 o DIN A6, in polistirolo

box zum einhängen für DIN A4, DIN A5 oder DIN A6 format, aus ps-polystyrol

container attachable for DIN A4, DIN A5 or DIN A6 format, made of polystyrene

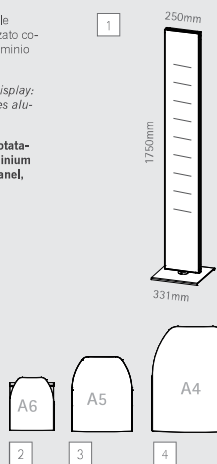

A dacapo twist

1	DCW1730250SZ	dacapo twist, black 1 pc
2	DCTA6	brochure pocket A6, 1pc
3	DCTA5	brochure pocket A5, 1pc
4	DCTA4	brochure pocket A4, 1pc



1 + 9x 4



tower da capo

MADE IN EU design by KD



IT è girevole, sta in piedi da solo e ha 3 superfici di presentazione: questo è ciò che le offre tower dacapo, l'espositore in alluminio anodizzato girevole in senso orario e antiorario. la base è composta da un pratico rivestimento di protezione in abs. nelle fessature trovano posto sia gli accessori magic che le tasche portacatalogo della linea dacapo.

DE drehbar, freistehend und drei präsentationsflächen: das alles bietet ihnen tower dacapo, das display aus eloxiertem aluminium lässt sich in beide richtungen drehen. die basis ist mit einem praktischen trittschutz aus abs versehen. die fräsungen passen für die magic accessoires ebenso wie zu den prospektschalen der dacapo linie.

EN rotating, freestanding and with three sided presentation panels: that's what tower dacapo offers you, the display is made of anodized aluminium and rotates in both directions. the base has a step on protection ring made of injection moulded abs plastic. you can attach the magic accessories as well as the dacapo brochure trays.



contenitori da appendere in formato DIN A4, A5 o DIN A6, in polistirolo.

box zum einhängen für DIN A4, DIN A5 oder DIN A6 format, aus ps-polystyrol.

brochure pocket attachable for DIN A4, DIN A5 or DIN A6 format, made of polystyrene.

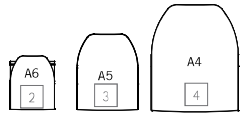

information

tre pannelli in alluminio anodizzato color argento, girevoli, montati su una base con rivestimento di protezione in abs color argento.

dreiseitiges silber eloxiertes aluminiumpaneel, frei drehbar montiert auf basis mit abs-trittschutz.

silver anodized aluminium three-way display, mounted on a freely rotating base with silver-plated step-on protection.

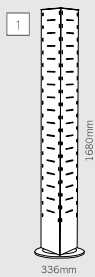

A tower da capo

1	MDTOW1680	tower dacapo, 1 pc
2	DCTA6	brochure pocket A6, 1 pc
3	DCTA5	brochure pocket A5, 1 pc
4	DCTA4	brochure pocket A4, 1 pc
5	MZIP300BRPC	brochure tray A4, 1 pc
6	MZIP6PRFI	magazine rack, 1 pc
7	MZIP158SRGG	acrylic glass-green shelf, 1 pc



5 brochure holder MZIP300BRPC

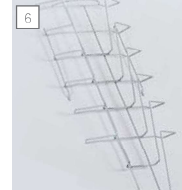

tasca portadepliant da agganciare sull'espositore in policarbonato antiurto e resistente ai raggi UV, per formato DIN A4.

prospektschale zum einhängen, aus uv-resistentem, bruchsickelem polycarbonat, für DIN A4 format.

brochure holder to hook on, uv- and shock-resistant polycarbonate, for DIN A4 size.

ripiano in acrilico color vetro, agganci laterali in alluminio anodizzato color argento, 158mmx-218mm (pxb).

ablage aus acrylglas glasgrün, seitliche halterungen silber eloxiertes aluminium, 158mmx-218mm (t.b).

acrylic glass tray, sideparts anodized aluminium, 158mmx218mm (d.w).



four face

MADE IN EU design by KD



IT quattro facce – 4 possibilità di presentazione: il portadepliant da terra girevole four face presenta su ognuno dei suoi quattro lati dei pratici fori ai quali è possibile agganciare le tasche portabrochure magic. Le tasche portadepliant in policarbonato antiurto sono disponibili in vari formati, sulla sua parte alta four face portadepliant possiede poi un'ulteriore tasca personalizzabile: basta stampare la grafica e inserirla su tutti e quattro i lati.

DE 4 seiten – 4x geballte präsentationskraft: der frei drehbare bodenprospekthalter four face bietet auf all seinen vier seiten fräsungen, in die sie die praktischen magic prospektaschen ganz einfach einhängen, die schlagfesten postertaschen aus polycarbonat-spritzguss sind in verschiedenen größen erhältlich, der freistehende broschürenhalter hat außerdem auf allen vier seiten am kopfteil eine postertasche: einfach grafik selbst ausdrucken und einlegen, so ist ihr four face schnell und einfach personalisiert.

EN 4 sides – 4 times concentrated presentation power: the free rotating floor display can be easily equipped with our convenient brochure pockets of the magic accessories program. magic brochure pockets are made of shock resistant polycarbonate and are available for different sizes, they are easily hooked into the cnc cutted notches, you can quickly customize the four face literature stand thanks to the acrylic poster pockets on top of each side: simply print out your logo and information and put it into the information displays.



freistehend und frei drehbar
struttura autoportante e girevole
freestanding and turnable

A four face

1	4FACE1930	four face, 1pc
2	MZIPA6BRPC	brochure tray A6, 1pc
3	MZIPA5BRPC	brochure tray A5, 1pc
4	MZIP300BRPC	brochure tray A4, 1pc

information

profili laterali in alluminio anodizzato color argento, pannelli composti in alluminio color argento, base in metallo verniciato a polvere, tasche portainformazioni in acrilico trasparente, sistema a libera rotazione.

seitliche profile aus silber eloxiertem aluminium, silberfarbene alu-verbundplatten, bodenplatte metall pulverbeschichtet, postertasche transparentes acryl, frei drehbar

lateral profiles made of silver anodized aluminium, aluminium composite panels silver colored, base in powder-coated metal, poster pocktes transparent acrylic, free turnable

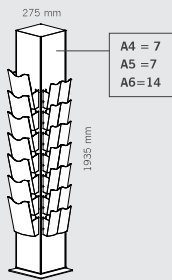

2 brochure tray A6



personalizzazione semplice e veloce: stampare la grafica ed inserirla nelle apposite tasche su tutti e quattro i lati. 300mm x 260mm

einfache und schnelle personalisierung: grafik ausdrucken, an allen vier seiten einlegen, fertig! 300mm x 260mm

quick and easy customizing: print your graphics and put it into the information displays on all its four sides, 300mm x 260mm

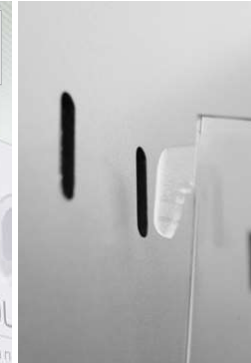

ai pratici fori è possibile agganciare le tasche portabrochure disponibili in diversi formati
prospektaschen verschiedener größen können einfach in die fräsungen eingehängt werden

the display can be easily equipped with brochure pockets of different sizes



tasche portadepliant in policarbonato antiurto, resistenti ai raggi UV, formati DIN A4, A5 e A6.

prospektschalen zum einhängen, aus uv-resistentem, bruchsiherem polycarbonat, für die formate DIN A4, A5 und A6.

brochure holders to hook on, uv- and shock-resistant polycarbonate, for DIN A4, A5 and A6.



advantages

- ✓ 4 lati di presentazione, struttura autoportante girevole
4 präsentationsflächen, freistehend und drehbar
4 presentation areas, freestanding and turnable
- ✓ tasche portainformazioni in acrilico disponibili in diversi formati
verschiedene größen an prospektaschen zur auswahl
selection of shock resistant brochure pockets in various formats
- ✓ possibilità di personalizzazione su tutti e quattro i lati
rundum einfach und schnell personalisiert
easily customizable on all four sides
- ✓ tasche portadepliant velocemente intercambiabili
prospektschalen schnell austauschbar
easy exchange of the brochure pockets
- ✓ massima libertà nella scelta del formato di presentazione
größe der prospektpräsentation frei wählbar
flexible for different brochure sizes