



bannersystem

**MONSTERFRAME FREESTANDING**



# freestanding additional banner outdoor advertising

## your advantages

- ➔ sistema modulare, banner sostituibile, profili semplici da tagliare
- ➔ modulares system, banner austauschbar, stangenware zum selbstzuschneiden
- ➔ modular system, exchangeable banner, profiles for self-cutting

**IT** utilizza il sistema outdoor monsterframe per i tuoi banner di misura 2x3m! perfetto per eventi, manifestazioni sportive e comunicazione su spazi aziendali. la visibilità è garantita! applicando un profilo connettore potrai addirittura aggiungere un secondo banner da 0,6x3m.

**DE** nutzen sie das freistehende monsterframe system für ihre large format banner von 2x3m im aussenbereich. ob bei events, sportstätten oder firmengelände: ihre werbung wird gesehen! bei bedarf können sie mit einer zusätzlichen querstange ein weiteres banner von 0,6x3m einsetzen, befestigt wird mit gummiexpandern und die banner können jederzeit von einer person ohne werkzeug befestigt und gewechselt werden.

**EN** use the freestanding monsterframe system for your large format banners in size 2x3m outdoor. for events, sports complexes or company sites: your promotion will stand out! in case you can add a cross beam and get a second banner with 0,6x3m size. the banner is mounted with rubber expander and can be exchanged by just one person anytime without tools.

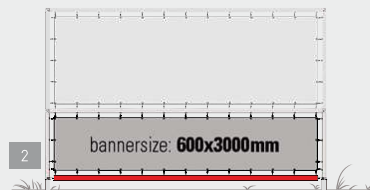
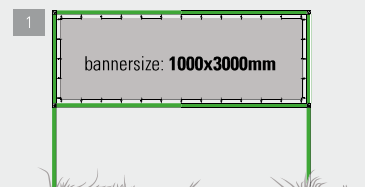

<b>B</b>	MONSTERFRAME FREESTANDING	
1	MFFS20003000	structure 2000x3000mm, 1set
*altre misure su richiesta   weitere masse auf anfrage   other sizes on request		

2	MFFCB3000	cross bar 3000mm, 1set
---	-----------	------------------------

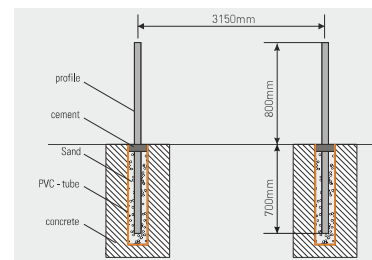

tubo PVC non incluso  
PVC-hülse nicht inklusive  
PVC-tube not included



con expander  
mit expander  
with expander



3D frame CUBOX

MADE IN EU design by KD

# 3D free-standing hanging elements 100% customizable

## your advantages

- ⇒ montaggio senza attrezzi  
dimensioni personalizzabili  
struttura leggera
- ⇒ Aufbau ohne Werkzeug  
personalisierbare Größen  
Struktur mit geringem Gewicht
- ⇒ tool-free assembling  
customizable sizes  
lightweight structure

**IT** soluzione creativa per realizzare elementi tridimensionali, sia autoportanti che a sospensione, 100% personalizzabili con la stampa su tessuto. articolo disponibile in misure standard o a composizione libera. montaggio senza attrezzi, semplice e veloce. stampe sostituibili in un attimo. possibilità di rivestire colonne e creare counter personalizzati applicando un pannello rigido sulla faccia superiore. illuminazione interna possibile. profili in alluminio anodizzato color argento.

**DE** kreatives Kadersystem für freistehende oder abgehängte 3D-Strukturen. 100% personalisierbar mit bedrucktem Stoffkeder, alle Komponenten erhältlich in Standard oder Länge auf Mass. schneller und einfacher Aufbau ohne Werkzeug, Bannertausch im Handumdrehen. perfekt um Säulen zu verdecken oder personalisierte Counter zu bauen mittels Plattenauflage auf der Oberseite. interne Beleuchtung optional möglich, silbermatt eloxierte Alu-Profile.

**EN** the creative way to make 3D free-standing or hanging elements. 100% customizable with printed fabric, components available in standard sizes or customized lengths for free form composition. quick and easy tool-free assembly, instantly replaceable prints. possibility to cover columns and create customized counters by setting a rigid panel on the top side. optional internal illumination, silver matt anodized aluminium profiles.

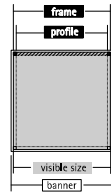

frame length =  
profile + 60mm

banner =  
visible size + 20mm



B	CUBOX	hxbxt
1	CUBOX3X1	cubox 1000x1000x1000mm, 1pc
2	CUBOX3X2	cubox 2000x2000x2000mm, 1pc
3	CUBOX SQUARE	cubox wall 3000x2500x350mm, 1pc

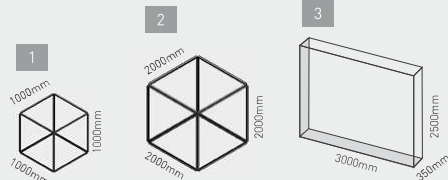

**importante!** per realizzare una struttura 3D servono:  
**wichtig!** um 3D-Strukturen zu bauen brauchen sie:  
**important!** to realize a 3D structure you need:

B	CUBOX PROFILE	
4	CUBOX350	cubox profile 350mm, set 4pcs
5	CUBOX500	cubox profile 500mm, set 4pcs
6	CUBOX1000	cubox profile 1000mm, set 4pcs
7	CUBOX1500	cubox profile 1500mm, set 4pcs
8	CUBOX2000	cubox profile 2000mm, set 4pcs
9	CUBOX2500	cubox profile 2500mm, set 4pcs
10	CUBOX3000	cubox profile 3000mm, set 4pcs



B	CUBOX ANGLE	
11	CUBOX AN	cubox angle, set, 8pcs

\*altre misure su richiesta | weitere masse auf anfrage | other sizes on request

illuminated frame

STARLED FLOOR



# illuminated floor frame extra thin design ready to use

## your advantages

- ➔ zero ombre sul banner stampato  
soluzione pronta e completa
- ➔ komplette ausleuchtung ohne  
schatten auf dem druck  
gebrauchsfertig mit allen bauteilen
- ➔ complete illumination without  
shadows on the print  
ready to use including all parts

**IT** espositore autoportante luminoso per banner in tessuto. soluzione monofacciale e bifacciale. cornice sottile, spessore 80mm. illuminazione uniforme garantita, zero ombre sulla superficie illuminata. disponibile anche in dimensioni fuori standard. soluzione completa: led laterali già installati, trasformatore e interruttore a spina a terra inclusi. semplice montaggio. profili in alluminio anodizzato color argento.

**DE** freistehendes, bodenleuchtdisplay für stoffbanner mit keder. einzel- oder beidseitige ausführung. schmaler rahmen, 80mm tief, gleichmässige, vollständige ausleuchtung ohne schatten auf der grafik. erhältlich auch in ausserstandard-grössen. gebrauchsfertig: led bereits an den profilen montiert, transformatoren und fuss-schalter inklusive. einfacher aufbau. silber matt eloxierte aluminium profile.

**EN** illuminated free-standing floor display for fabric banners. single or double side version. slim frame design, 80mm thick. uniform illumination guaranteed, completely illuminated, no shadows on image. also available in customized sizes. ready to use: leds already mounted to the profiles, transformer and foot switch included. easy set up. silver matt anodized aluminium profiles.



luci led di alta qualità  
hochwertige led-leuchten  
first choice led-lights

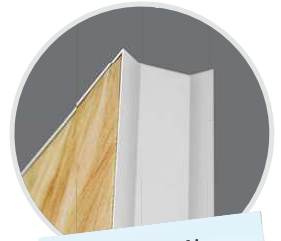

SLIM DESIGN  
spessore 80mm  
80mm tiefe  
80mm thick

interruttore a terra  
fuss-schalter  
foot switch



### information

frame length = profile + 60mm

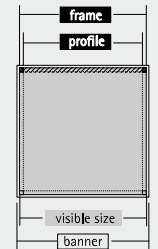

banner = visible size + 20mm

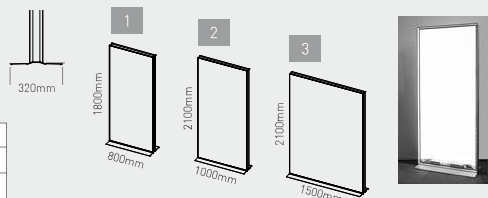
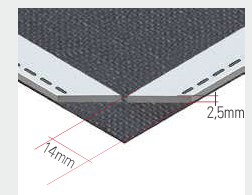

### B STARLED FLOOR

1	STLDFL1800800	starled floor 1800x800mm, 1pc	
2	STLDFL21001000	starled floor 2100x1000mm, 1pc	
3	STLDFL21001500	starled floor 2100x1500mm, 1pc	

\*altre misure su richiesta | weitere masse auf anfrage | other sizes on request







illuminated frame

STARLED

MADE IN EU design by KD

# starLED complete illumination extra slim

## your advantages

- ➔ forte illuminazione e cornice invisibile
- ➔ extra starke leuchtkraft und unsichtbarer rahmen
- ➔ extra strong illumination and invisible frame

**IT** un messaggio davvero brillante! la cornice illuminata starled per banner in tessuto è una vera e propria attrazione. la tua stampa sarà valorizzata grazie all'illuminazione con tecnologia led moderna ed elegante. i profili in alluminio anodizzato color argento sono tagliati a 45° tagliati verso l'interno sono praticamente invisibili. le strisce led sono montate su un pannello in alluminio composito, mentre i cavi di alimentazione sono posti lateralmente garantendo alla cornice uno spessore di soli 50mm.

**DE** eine echte glanzleistung: das beleuchtete stoffbanner-rahmensystem starled ist ein strahlender hingucker. ihr druck kommt durch die komplette ausleuchtung dank modernster, hochwertiger led-technologie voll zur geltung. der silber eloxierte aluminiumrahmen wurde nach hinten abfallend konzipiert, so dass er kaum sichtbar ist. ein aluminium-verbund paneel dient als trägerwand für die ledstreifen. kunststoffstreifen ermöglichen die verlegung des kabels so dass der rahmen mit nur 50mm tiefe extrem schmal ist.

**EN** brilliant performance: starled the illuminated frame for textile banners is an extra bright eye-catcher! your print will gain full attention thanks to modern high-quality led technology. the silver anodized aluminium frame is shaped backwards, making the frame almost invisible. the led strips are mounted on an aluminium composite panel with synthetic strips for cable feed allowing an extremely low frame thickness of only 50mm.

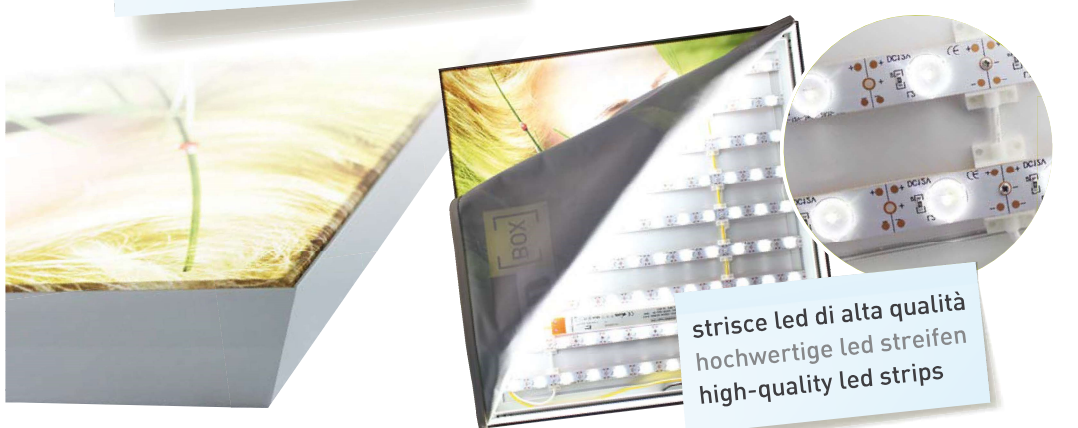

strisce led di alta qualità  
hochwertige led streifen  
high-quality led strips

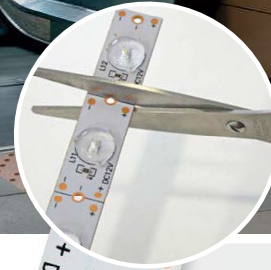
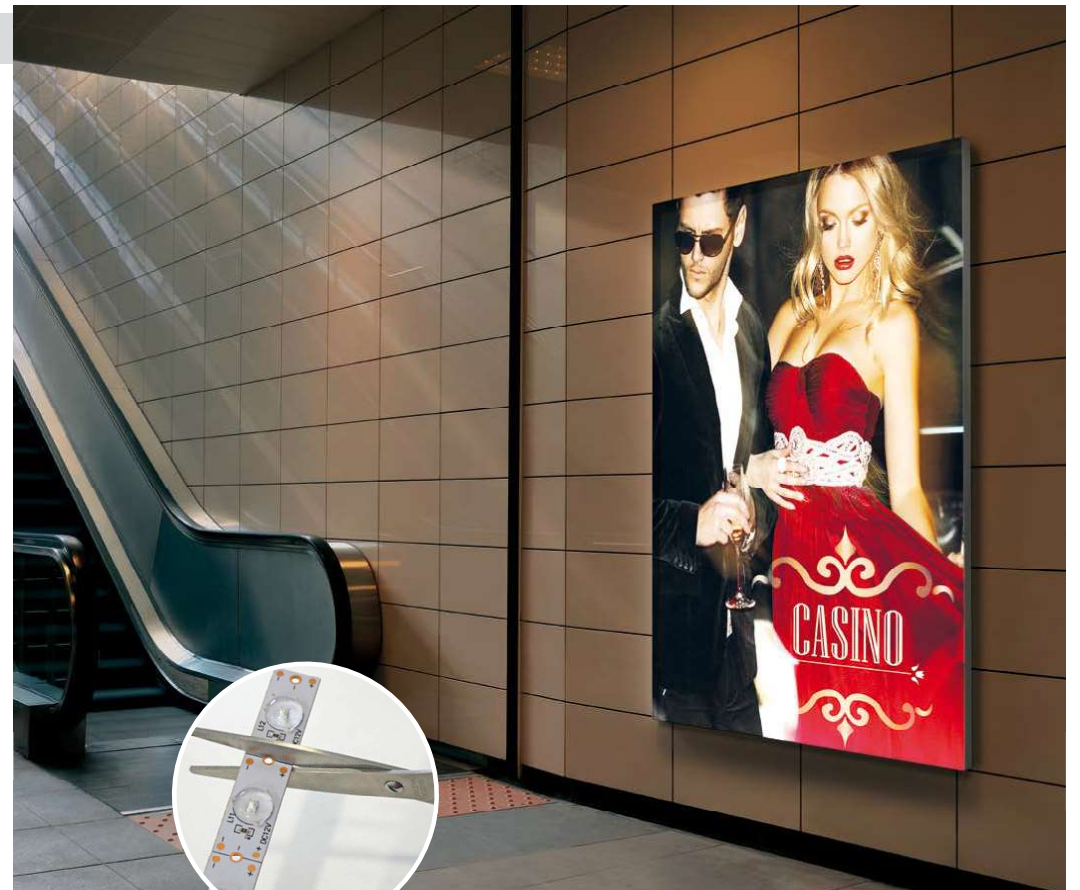
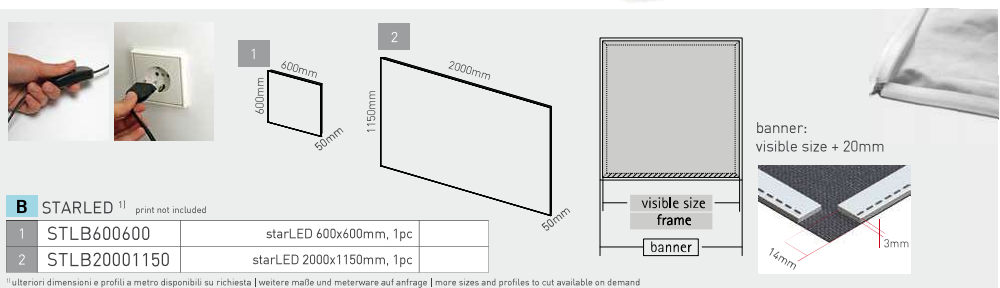

- 1 silver anodized aluminium profile, edges are mitered at 45°
- 2 first choice led-lights: 12 led per strip with 3,6W (12V) each
- 3 synthetic supports for led mount
- 4 electric cable
- 5 electric cable
- 6 edge connectors made of zincd metal
- 7 edge connectors made of zincd metal
- 8 kingbond panel
- 9 screws
- 10 double adhesive tape
- 11 transformator
- 12 banner piping for sewing
- 13 banner piping self-adhesive

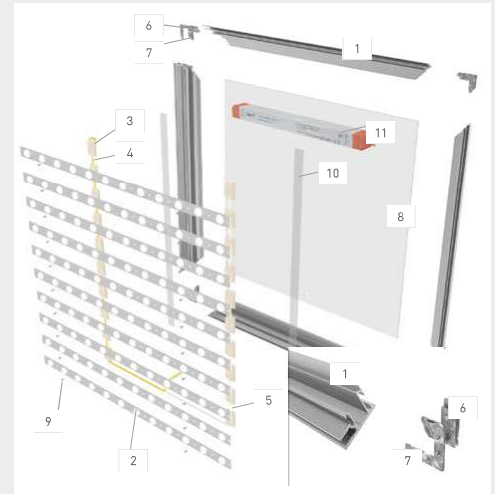





illuminated pockets **FLY SHINE LIGHT**



# illuminated acrylic poster pockets wall or ceiling suspension

## your advantages

- ➔ luce uniforme tra le tasche soluzione pronta e completa
- ➔ gleichmäßige ausleuchtung aller postertaschen, Komplettlösung
- ➔ uniform illumination of the poster pockets complete set all inclusive

**IT** tasche porta informazioni monofacciali di altissima qualità. una soluzione applicabile con semplicità alla parete e al soffitto. le componenti elettriche sono premontate: per il montaggio basterà quindi fissare i cavi, la scatola del trasformatore e il pannello. l'illuminazione resta uniforme tra le tasche nonostante il passare degli anni. la scatola del trasformatore può essere personalizzata con loghi e slogan.

**DE** hochwertige einseitige, beleuchtete postertaschen, die lösung für wand- oder deckenabhängung. wir liefern bereits am spannsel montiert, Sie müssen nur noch die befestigungen anbringen und die transformatoren und paneele in der höhe einstellen. eine gleichmäßige und uniforme ausleuchtung ist garantiert, gleichbleibende leuchtkraft der paneele auch über längere zeit. der transformator lässt sich mit logos oder slogans personalisieren.

**EN** top-quality, single-sided poster pocket. a solution for wall or ceiling suspension. comes already assembled, simply fix the wall mounts and adjust the height. uniform illumination of the poster pockets. the transformer box can be customized with logos and slogans.

- a transparent acrylic
- b laser pointed rear
- c LED
- d LED cover
- e panel support
- f steel cable

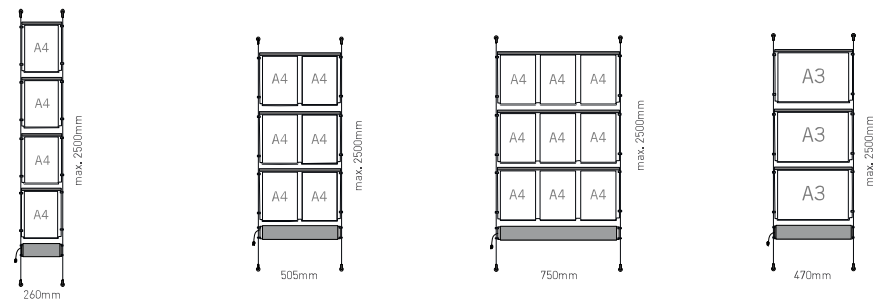
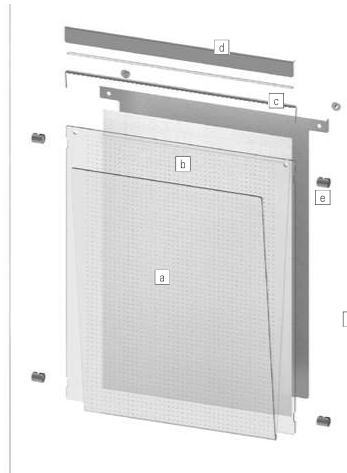

**B** FLY SHINE LIGHT

1	YSES4X1A4V	set 4x1 A4 V, 1pc
2	YSES3X2A4V	set 3x2 A4 V, 1pc
3	YSES3X3A4V	set 3x3 A4 V, 1pc
4	YSES3XA3H	set 3x1 A3 H, 1pc
5	YSESLIGHT700500	set 700x500mm V, 1pc

## SET FLY SHINE LIGHT

- 4pcs wall or ceiling supports
- 1x5m steel cable
- led-illuminated poster pockets
- transformator container in silver anodized aluminium





illuminated pockets

**FLY SHINE LIGHT**



**COMBINATION SET**

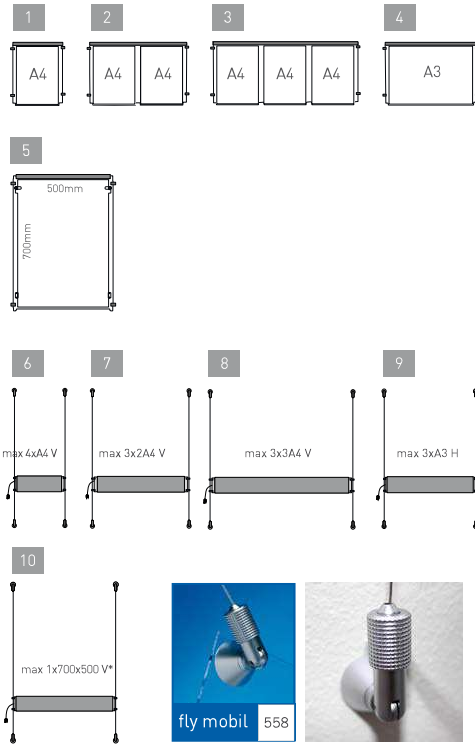

fissaggi fly mobil per cavo a parete o soffitto, in ottone cromato color argento satinato  
wand- und deckenhalter fly mobil für spannsel, aus silbermatt verchromtem messing  
wall- and ceiling support fly mobil for cable, made of silvermatt plated brass

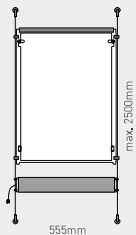

single side transparent acrylic poster pockets, rear side laser dots, with lateral cable supports made of silver matt plated brass, led with silver anodised aluminium cover

**B FLY SHINE LIGHT**

1	YSEPLIGHT700500*	set 700x500mm V, 1pc
---	------------------	----------------------

**B FLY SHINE LIGHT**

1	YSEPLIGHT1A4V	panel 1 A4 V, 1pc
2	YSEPLIGHT2A4V	panel 2 A4 V, 1pc
3	YSEPLIGHT3A4V	panel 3 A4 V, 1pc
4	YSEPLIGHT1A3H	panel 1 A3 H, 1pc
5	YSEPLIGHT700500	panel 700x500mm V, 1pc
6	YSETKLIGHTA4V	transformator kit A4 V, 1pc
7	YSETKLIGHT2A4V	transformator kit 2x A4 V, 1pc
8	YSETKLIGHT3A4V	transformator kit 3x A4 V, 1pc
9	YSETKLIGHTA3H	transformator kit A3 H, 1pc
10	YSETKLIGHT700500*	transformator kit 700x500, 1pc

\* non combinabile con 2 A4 | nicht kombinierbar mit 2 A4 | cannot be combined with 2 A4

illuminated pocket

**FLY SHINE TABLE**

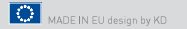

**IT** espositore da banco illuminato. soluzione monofacciale, tasca inclinata per facilitare la lettura. semplice cambio dell'informazione. vetro acrilico lavorato a laser, 30.000 ore di illuminazione perfetta garantite. base: profilo in alluminio anodizzato color argento.

**DE** einseitiges, beleuchtetes thekendisplay für poster, schneller info-tausch. acrylglas-streuscheibe mit lasergravur, 30.000 stunden konstante ausleuchtung, basis aus silber matt eloxiertem alu-strangprofil.

**EN** single-side illuminated counter display. easy information exchange. laser engraved acrylic diffusion disc, 30,000 hours of constant illumination. base: silver matt anodized aluminium extrusion.

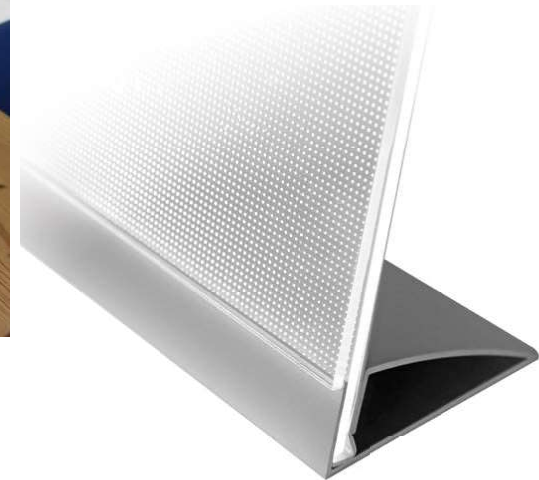

semplice cambio dell'informazione  
einfacher infotausch  
easy information exchange

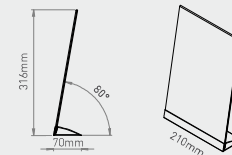

**B FLY SHINE TABLE**

1	YSETABLE	fly shine table, 1pc
---	----------	----------------------





digital presentation

**VELO MEDIA RESTYLE**



# 8" display digital presentation multimedia

**IT** rendi multimediali le tue presentazioni: il classico velo si trasforma in velomedia. sotto lo schermo di 8" trovi lo spazio per esporre depliant in formato A4. tutti gli accessori della serie velo si possono utilizzare, dandoti così la possibilità di creare valore aggiunto grazie alle personalizzazioni.

**DE** werden sie multimedial in ihrer präsentation: der klassische velo zip wird zum velo media. unter dem 8" bildschirm hat velo media ein fach für printmedien in A4. das zubehör der velo serie passt auch zum velomedia und bietet ihnen mehrwert durch zusätzliche, personalisierbare werbeflächen.

**EN** make your presentation multimedia-based: the classic velo zip becomes velo media. below the 8" screen velo media has a brochure tray for A4 printed material. all the accessories of the velo series also fits to your velomedia giving you more value with additional customizable ad space.

**your advantages**

- ➔ schermo lcd 8" digitale
- ➔ lcd 8" digitaler bilderrahmen
- ➔ lcd 8" digital picture frame



memory card included

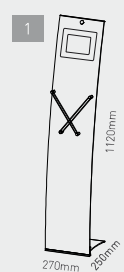

8" screen

pannello alluminio anodizzato,  
1set VELOAT01 per 1 A4 incluso  
paneel silber eloxiertes aluminium,  
1 set VELOAT01 für 1 A4 fach inklusive.  
silver anodized aluminium panel,  
1 set VELOAT01 for 1 A4 incl.

A VELO MEDIA RESTYLE		
1	VELOMNR8AA	velo media restyle, 1pc
2	BBVELO*	velo bannerblock set, 2pcs
3	VELOA4*	velo poster pocket A4, 1pc
4	VELODIV02	velo divider for 2 A6, 2 pcs

\*fino ad esaurimento scorte | solange vorrat reicht | while stock last

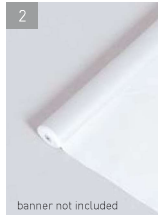

banner not included

accessori velo: portainformazioni in A4 verticale; velo divider per 2 depliant formato A6L; 2 profili bannerblock per una personalizzazione posteriore, grazie ad una stampa digitale  
velo zubehör: A4 postertasche, velo divider für 2 A6 prospekte, 2 bannerblock klemmp Profile für personalisierung der rückseite  
velo accessories: A4 poster pocket, velo divider for 2 A6 brochures, 2 bannerblock extrusions for customizing rear side with prints



bannerblock facile da appoggiare  
bannerblock einfach einhängen  
bannerblock easily attachable

banner not included



# magnetic brochure holder free configuration

## your advantages

- ➔ configurazione libera e pannello magnetico
- ➔ frei konfigurierbar und magnetisch
- ➔ free configuration and magnetic

**IT** un portabrochure elegante e con grande stile, velo magic restyle si assembla con grande rapidità: basta inserire il pannello metallico nella base in alluminio e fissarlo sul retro attraverso il cavo in dotazione. Il pannello metallico fresato vi permette di poter utilizzare tutti gli accessori della linea magic. le tasche portabrochure sono disponibili in diversi formati e possono essere posizionate all'altezza desiderata. l'espositore da terra è color bianco opaco e ha una perfetta stabilità.

**DE** ein eleganter prospektständer im angesagten look. die zweiteilige grundstruktur des velo magic restyle ist schnell aufgebaut: einfach das metall-paneel in die aluminium basis stecken und mit dem spannseil befestigen. das paneel ist mit speziellen fräsungen versehen: so können sie alle accessoires der magic reihe einfach ein- aus und umhängen. die prospekt- und infotaschen sind in verschiedenen grössen erhältlich und frei konfigurierbar. das freistehende bodendisplay ist in trendigem matt weiss und von hoher standfestigkeit.

**EN** an elegant brochure holder in trendy look. the two-part display of velo magic restyle is quickly set up: simply insert the metal panel into the aluminium base and mount the cable rod. the panel comes with notches that allow to attach all the accessories of the magic series. brochure and info pockets are available in different sizes and can be freely attached. the free standing floor display comes in white matt and has a perfect stability.

tasca aggiuntiva  
individuell bestücken  
assemble individually

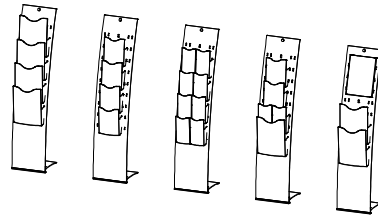

**A** VELO MAGIC RESTYLE

1	VMAR165WH	velo magic restyle, 1pc
2	PQMA4	pixquick magic A4, 1pc
3	MZIPA6BRPC	brochure holder A6, 1pc
4	MZIPA5BRPC	brochure holder A5, 1pc
5	MZIP300BRPC	brochure holder A4, 1pc
6	MDIV02	magic divider for 2 A6, 1pc
7	ACAL20CM	magnet chrome ø20mm, 10pcs

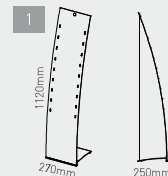

pixquick magic A4 orizzontale, in policarbonato trasparente, con supporti in alluminio anodizzato color argento.  
pixquick magic A4 vertikale: transparentes polycarbonat, mit silber eloxierten aluminium halterungen.  
pixquick magic A4 horizontal: transparent polycarbonate, with silver anodized aluminium supports.



tasca portadepliant da agganciare sull'espositore in policarbonato antiurto e resistente ai raggi UV, per formato DIN A6, A5, A4. prospekttschale zum einhängen, aus uv-resistentem, bruchsicherem polycarbonat, für DIN A6, A5, A4 format.  
brochure holder to hook on, uv-resistant, shock proof polycarbonate, for DIN A6, A5, A4 size.



magic divider acrilico trasparente, divide la tasca A4 (MZIP300BRPC) in 2 scomparti per A6. si inserisce nella tasca.  
magic divider transparentes acrylglas, unterteilt durch ein Schub die prospekttschale A4 (MZIP300BRPC) in 2 A6 fächer.  
magic divider transparent acrylic, put into the A4 brochure tray MZIP300BRPC and get a place for 2 A6.



ordina i funzionali bottoni a calamita in aggiunta al pannello. praktische magnete extra-bestellen.  
order extra the handy magnet buttons.





floor display

V. SHARK RESTYLE

MADE IN EU design by KD

**IT** L' espositore da terra autoportante velo shark ha ancora più carattere nella sua nuova versione restyle: il pannello metallico laccato bianco può essere completato con le varie tasche portainformazioni pixquick disponibili in diversi formati. Il pannello metallico e la base in alluminio garantiscono una grande stabilità. Il nostro consiglio: utilizzalo anche per appendere dei fogli e fissarli semplicemente con una calamita.

**DE** das beliebte freistehende bodendisplay velo shark bietet in der restyle version extra biss: das matt weiß lackierte metall-paneel kann von ihnen frei mit postertaschen pixquick in verschiedenen formaten gestaltet werden. metall-paneel und aluminium basis sorgen für sicheren stand. unser tipp: bringen sie einfach und schnell infoblätter mit magneten am paneel an.

**EN** the popular free standing floor display velo shark has even more teeth in the redesigned version: to the matt white coated metal panel you can easily attach our poster pockets pixquick in different formats. our tip: fix paper information with magnet buttons directly to the panel.



fissaggio tramite nastro biadesivo  
befestigung mit doppelkleber  
fix with double-side adhesive tape

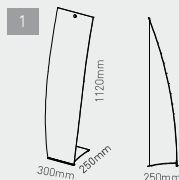
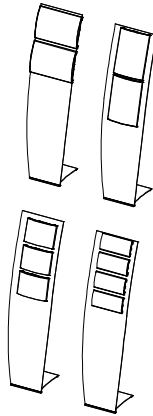

**A** VELO SHARK RESTYLE

1	VELOSHR1200CO	velo shark restyle, 1pc
2	PQA6L	pixquick A6L, without support, 1pc
3	PQA6	pixquick A6, without support, 1pc
4	PQA5	pixquick A5, without support, 1pc
5	PQA4	pixquick A4, without support, 1pc
6	PQA3	pixquick A3, without support, 1pc
7	SMQ105150WH	smartquick 105x150mm, 1pc
8	SMQ150150WH	smartquick 150x150mm, 1pc
9	SMQA4WH	smartquick, A4, 1pc
10	SMQA3WH	smartquick A3, 1pc
11	ACAL20CM	magnet chrome ø20mm, 10pcs



porta informazioni in policarbonato trasparente stampato ad iniezione, biadesivo incluso. postertasche aus transparentem polycarbonat spritzguss, incl. doppelkleber. poster pocket made of transparent polycarbonate die-cast, incl. double sided adhesive tape.



porta informazioni in policarbonato trasparente stampato ad iniezione, biadesivo incluso. postertasche aus transparentem polycarbonat spritzguss, incl. doppelkleber. poster pocket made of transparent polycarbonate die-cast, incl. double sided adhesive tape.



ordina in aggiunta al pannello i funzionali bottoni a calamita. praktische knopfmagnete extra dazu bestellen. just order extra the handy magnet buttons.



floor display

VELO RESTYLE

MADE IN EU design by KD



o-ring flessibili  
flexible o-rings  
flexible o-rings

**IT** velo, il famoso espositore da terra in color bianco. Gli o-ring trasparenti rendono velo restyle un pannello informativo e un portadepliant allo stesso tempo. Il pannello metallico e la base in alluminio lo rendono semplicemente perfetto.

**DE** das bekannte bodendisplay velo in matt weiss. transparente o-ringe machen velo restyle zum infopaneel und prospektständer gleichermaßen. metall-paneel und aluminium-basis garantieren einen perfekten stand.

**EN** the popular floor display velo in matt white. transparent o-rings make velo restyle into an information panel and brochure holder at the same time. metal panel and aluminium base guarantee a perfect stand.

divider: divisore per due depliant formato DIN A6 verticale. divider: unterteilung für 2 prospekte DIN A6 vertikal. divider: for two A6 brochures vertical



MORE ACCESSORIES page 75

**A** VELO RESTYLE

12	VELORWH	velo restyle, 1pc
13	VELODIV02	velo divider for 2 A6, 2pcs

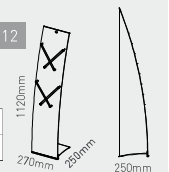



magnetic floor display **STAND UP**



**world's quickest display**  
**double sided**  
**magnetic**  
**customizable base**



**UNIQUE**  
 double-sided  
 display

**IT** la struttura e il banner formano in questo caso la copia perfetta! la struttura incornicia perfettamente il banner, mono o bifacciale, dando risalto all'informazione. la base in alluminio, le aste laterali, i profili in alluminio e i dettagli in materiale sintetico rendono l'intera struttura stabile. il listello metallico applicato a pressione al banner si aggancia al profilo in alluminio tramite dei magneti posizionati all'interno del profilo stesso, rendendo il cambio del banner estremamente veloce e semplice in qualsiasi luogo. disponibile anche la borsa per il trasporto.

**DE** display und banner sind bei myMAGO stand up ein unschlagbares team. die struktur sorgt für den passenden rahmen, das ein- oder doppelseitige banner für einen perfekten auftritt. das display besteht aus einer einfach und schnell aufzubauenden struktur aus eloxiertem aluminium mit kunststoffverbindern. das besondere highlight ist aber die bannerbefestigung mit magnettechnik. der bannerwechsel ist von jedem anwender spielend leicht und blitzschnell erledigt. die struktur selbst bleibt bestehen und wird so nachhaltig und langfristig verwendet. ob im einzelhandel, dienstleistungssektor, auf messen oder events: der myMAGO stand up ist ein gewinner. tasche für mobilen einsatz erhältlich.

**EN** a stable floor display, set up without tools and a one or double-side banner presentation that is what myMAGO stands for. the structure is reuseable and the banner exchange is so easy that you will never miss it again. the banner with its metal strips attaches itself almost by itself thanks to the integrated magnets. in your showroom, for events or exhibitions myMAGO is perfectly also for the mobile use thanks to its convenient transport bag.



**5** ti forniamo anche una pratica e resistente borsa per il trasporto su richiesta für den mobilen einsatz bieten wir ihnen eine praktische transport-tasche for the mobile use we provide you with a transport bag

A	STAND UP		
1	MMSU1600600AR	stand up 1632x604mm, 1pc	
2	MMSU2000600AR	stand up 2032x604mm, 1pc	
3	MMSU2000850AR	stand up 2032x854mm, 1pc	
4	MMSU20001000AR	stand up 2032x1004mm, 1pc	

BAG		
5	MGSBGPR	bag premium, 1pc

V-METAL RAIL <sup>1)</sup>		box 50	box 200	1pc
6	MGS2VL550	v-metal leiste 2.0 550mm		
7	MGS2VL800	v-metal leiste 2.0 800mm		
8	MGS2VL950	v-metal leiste 2.0 950mm		

<sup>1)</sup>disponibile solamente in box da 50pz/200pz | nur in box 50/box 200 erhältlich | only available in box with 50pcs/200pcs

PRESS		
9	MGSPRESS	manual press, 1pc

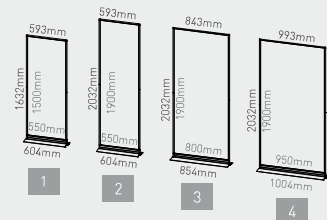

page 1.18



**6-8**  
 listelli v-metal da applicare a pressione al banner stampato v-metall-schienen mit dem druck verpressen press the metal rails to the banner



**9**  
 pressa per l'applicazione dei listelli v-metal a banner in carta o pvc. presse für die befestigung der metall-schienen an bannern aus papier oder pvc. press to fix the metal rails to banners made of paper or pvc.



**base personalizzabile**  
 basis personalisierbar  
 base customizable

bastano pochi passaggi per montare l'espositore. in nur wenigen schritten bauen sie das diisplay auf. the display is assembled in just a few steps.

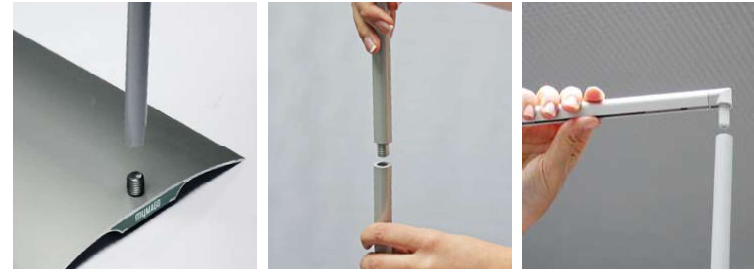



bannersystem

MYMAGO C-MODULE



# world's quickest display double sided modular system

## your advantages

- ➔ struttura leggera, semplice da montare, più superfici da personalizzare
- ➔ leichtes gewicht, schnell aufgebaut, viele werbeflächen
- ➔ low weight, quick set up, advertising space

**IT** amplia il tuo sistema espositivo aggiungendo ulteriori espositori. grazie a questo connettore a C potrai aumentare il numero di superfici pubblicitarie, il sistema magnetico resta sempre lo stesso. massima flessibilità, successo garantito.

**DE** erweitern sie das clevere bodendisply durch einfaches anbauen von weiteren strukturen. durch einsetzen eines C-verbinders können sie das system im nu verlängern, die magnettechnik bleibt dabei immer dieselbe. so ist unbegrenzt platz für weitere displays.

**EN** extend the clever display by adding more structures. Use a C-connector to expand the system, the magnetic technique stays the same. you are perfectly prepared for your presentation, thanks to the infinite number of displays you can add.

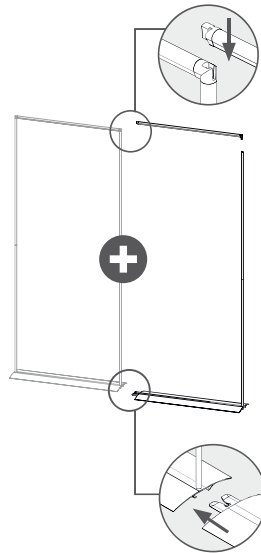

A	MYMAGO C-MODULE		
1	MMCM1600600AR	c-module 1600x600mm, 1set	
2	MMCM2000600AR	c-module 2000x600mm, 1set	
3	MMCM2000850AR	c-module 2000x850mm, 1set	
4	MMCM20001000AR	c-module 2000x1000mm, 1set	

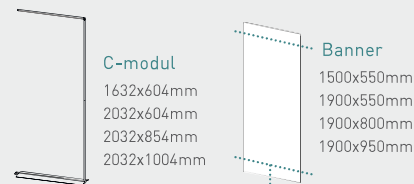

costruisci la tua parete  
bauen sie eigene wände  
build your own walls

lamp

DISPLAY LAMP

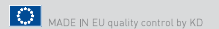

**IT** poca luce nello spazio espositivo?! dona luce al tuo banner con la lampada KD, ruotabile in tutte le direzioni. l'attacco a molletta viene fissato direttamente al profilo. lampada LED (5W), cavo (3m) incl.

**DE** kein perfektes licht an ihrem präsentationsstandort? heben sie sich mit unserer lampe hervor und lassen sie die anderen im dunkeln stehen. der kopf ist in alle richtungen drehbar und leuchtet ihre motive so aus, wie sie es wünschen. der praktische klemmhalter wird einfach direkt am profil befestigt. im lieferumfang ist ein LED-leuchtmittel (kaltes licht) 5 watt, mit 3m kabel inklusive.

**EN** looking for a spotlight to illuminate your presentation? get this lamp and let the others stay in the dark. the head is turnable in all directions and highlights your motives, the way you want it. the practical holding clamp is simply clipped directly to the profile. we provide you with a LED lamp (cold light temperature) 5W, 3m cable incl.

A DISPLAY LAMP

1	MMGLAMP	mymago lamp, 1pc
---	---------	------------------





huge choice of sizes  
sustainable  
different banner materials

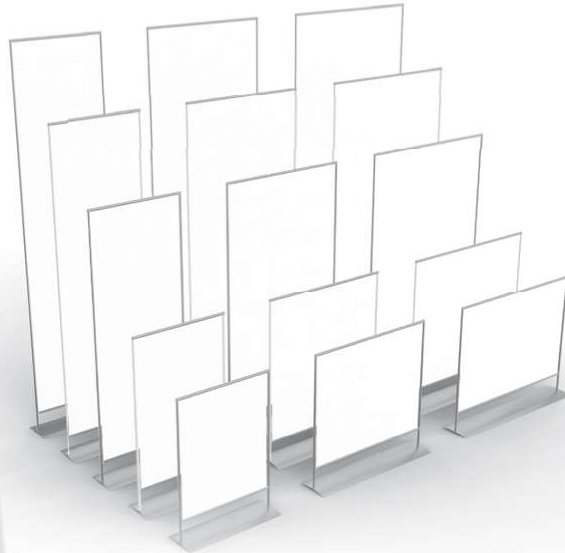

your advantages

- ⇒ l'espositore più veloce del mondo
- ⇒ das schnellste display der welt
- ⇒ the world's quickest display

**UNIQUE**  
double-side  
display



banner not included

divided banner  
**magnetic**  
maximum flexibility

your advantages

- ⇒ cambia solo la parte con le informazioni da modificare
- ⇒ jedes banner jederzeit ganz einfach unabhängig voneinander wechseln
- ⇒ exchange each banner anytime independently from another

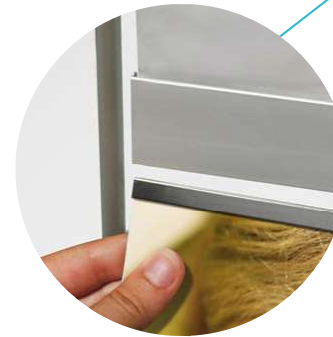
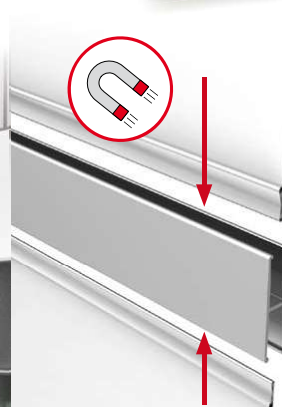

**IT** puoi stampare banner solo fino a una certa dimensione, oppure desideri cambiare solo una parte della grafica? grazie ai profili di connessione potrai farlo! basterà unire i banner con il profilo magnetico anodizzato e potrai cambiare la parte che preferisci.

**DE** sie können nur bis zu einem bestimmten maß drucken oder wollen für aktuelle angebote nur einen teil der grafik wechseln? mit unseren cleveren banner-verbindern geht auch das! einfach die banner mit der silber eloxierten magnetischen leiste verbinden und schon kann jeder teil für sich beliebig getauscht werden.

**EN** you can print only up to a certain size or you need to change only a part of the banner for marketing reasons? thanks to our smart banner connectors - yes you can! simply connect the banners with the silver anodized magnetic profile, allowing you now to exchange both parts each separately.



banner not included

A	MYMAGO LINK	
1	MMLK550	mymago link 550mm, 1pc
2	MMLK800	mymago link 850mm, 1pc
3	MMLK950	mymago link 950mm, 1pc

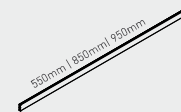



# floor display quick banner exchange 3 colors



banner not included

**IT** l'espositore autoportante da terra hans, disponibile in color argento, bianco o nero, si monta e smonta con grande rapidità. il banner si cambia in pochi secondi grazie al sistema magnetico brevettato. per il montaggio della struttura e il cambio del banner non sono necessari attrezzi. disponibile in diverse dimensioni, anche per presentazioni bifacciali.

**DE** das freistehende bodendisplay hans in den farben silber, weiß oder schwarz ist super schnell auf- und abgebaut. der banner ist dank patentierter magnettechnik in wenigen sekunden gewechselt. der aufbau und der bannerwechsel erfolgen ohne werkzeug. erhältlich in diversen grössen, auch für die doppelseitige präsentation.

**EN** the free standing floor display hans in silver, white or black will convince you by its easy set up and disassembling. you can change the banner in a few seconds thanks to the patented magnetic design. setup and banner exchange are done without any tools. richard is available in different sizes, also perfect for double-sided presentation.

magnetico  
magnetisch  
magnetic

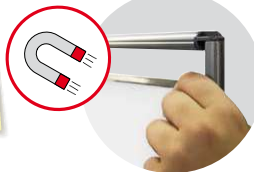

page 1.14

tasca portadepliant magnetica realizzata in acrilico trasparente. fissaggio al banner attraverso gli appositi magneti posti sul retro della tasca e sul banner.

prospekttaschen aus transparentem acryl zur befestigung im sandwich-system: banner zwischen rückseite und prospekttasche mit magnet einklemmen.

brochure pockets made of transparent acrylic: clamp the banner with magnets between pocket and rear magnetic part.



A	HANS	
1	MGS2H1600600SW*	1600x600mm, black, 1pc
2	MGS2H1600600AR*	1600x600mm, silver, 1pc
3	MGS2H1600600WH*	1600x600mm, white, 1pc
4	MGS2H2000850SW*	2000x850mm, black, 1pc
5	MGS2H2000850AR*	2000x850mm, silver, 1pc
6	MGS2H2000850WH*	2000x850mm, white, 1pc
7	MGS2H20001000SW*	2000x1000mm, black, 1pc
8	MGS2H20001000AR*	2000x1000mm, silver, 1pc
9	MGS2H20001000WH*	2000x1000mm, white, 1pc
10	MGS2H20001200SW*	2000x1200mm, black, 1pc
11	MGS2H20001200AR*	2000x1200mm, silver, 1pc

page 1.18

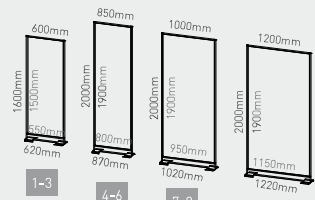

# magnetic removable different sizes

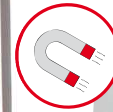

tasca aggiuntiva  
individuell bestücken  
assemble individually

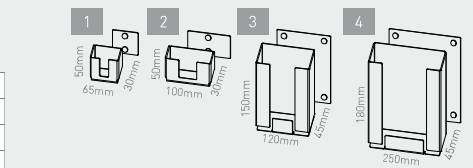

A	MAGNETIC POCKET	
1	MGSMTNCV	pocket for visit cards vertical
2	MGSMTNCH	pocket for visit cards horizontal
3	MGSMTA6V	pocket A6 vertikäl
4	MGSMTA5V	pocket A5 vertikäl





wood floor display

**ECO STAND**

MADE IN EU quality control by KD



**ecological  
floor display  
single-sided  
reusable structure**

**IT** display da terra in legno con sistema magnetico brevettato per un veloce e semplice cambio dell'informazione: sostenibile, ecologico e riciclabile.

**DE** lucy standdisplay aus holz mit patentierter magnettechnik für den schnellen und einfachen bannerwechsel: nachhaltig wiederverwendbar, ökologisch und recyclebar.

**EN** floor display made of wood with patented magnetic technique for quick and easy banner exchange: sustainable, reusable, ecological and recyclable.

**your advantages**

- ⇒ sostenibile, ecologico e riciclabile
- ⇒ umweltfreundlich, nachhaltig und wiederverwendbar
- ⇒ eco-friendly, sustainable and re-usable



magnetico  
magnetisch  
magnetic

<b>A</b>	<b>ECO STAND</b>		
1	MGSL1900800WD	eco stand, 1pc	
<b>A</b>	<b>MAGNETIC POCKET</b>		
2	MGSMTNCV	pocket for visit cards vertical	
3	MGSMTNCH	pocket for visit cards horizontal	
4	MGSMTA6V	pocket A6 vertikál	
5	MGSMTA5V	pocket A5 vertikál	

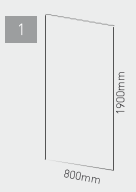

page 1.18



**A5 wood display**

**COUNTER DISPLAY**

MADE IN EU design by KD

**IT** pratico display da banco in formato A5 con sistema magnetico brevettato. supporto in legno naturale

**DE** handlicher tischausteller im A5 format mit magnettechnik. display in holz natur.

**EN** handy counter display with double side for poster format A5 with magnetic patent. display made of wood in natural look.



tasca portadepliant magnetica realizzata in acrilico trasparente. fissaggio al banner attraverso gli appositi magneti posti sul retro della tasca e sul banner.

tolle prospektaschen aus transparentem acryl zur befestigung im sandwich-system: einfach banner zwischen rückseite und prospektasche mit magnet einklemmen.

great brochure pockets made of transparent acrylic: simply clamp the banner with magnets between pocket and rear magnetic part.

page 1.14

<b>A</b>	<b>COUNTER DISPLAY</b>		
6	MGSRA5WD	counter display wood A5, 1pc	

banner not included



press for metal strips

MANUAL PRESS 2.0



produttività: 200 pressature l'ora  
produktivität 200 verpressungen/h  
productivity: 200 pressings/h

**IT** la pressa manuale può essere assemblata dove ti è più comodo, una volta montata potrai fissare molto semplicemente i listelli metallici 2.0 ai tuoi banner. sarà sufficiente posizionare il listello nell'incavo della pressa, inserire il banner nel listello e spingere verso il basso le maniglie che presseranno il listello al banner

**DE** die manuelle presse kann überall eingesetzt werden und konfektioniert ihren banner einfach und schnell durch verpressung mit metall-leisten der version 2.0. einfach die leisten einlegen, das banner einschieben und mittels hebelkraft verpressen. produktivität 200 verpressungen/h

**EN** the manually operated press can be easily used anywhere. the press helps you to connect the metal-strips version 2.0 easily with your banner. simply insert the metal strip, put the banner inside and then press down the levers connecting thus banner and metal strip.



C MANUAL PRESS 2.0

1	MGSPRESS	manual press 2.0, 1pc
---	----------	-----------------------

press for adhesive tape

Z-TICK PRESS



fissaggio rapido e preciso  
schnelle und akkurate beileistung  
quick and accurate banner finish

**IT** pressa manuale per il fissaggio rapidissimo, perfetto e semplice dei listelli metallici z-tick con biadesivo al banner.

**DE** manuelle presse zur zeitsparenden, perfekten, einfachen und geraden fixierung der metall-leisten mit doppelkleber z-tick am banner. z-tick leisten in die magnetvorrichtung einlegen, banner positionieren, verpressen - fertig.

**EN** manual press for time-saving, perfect, easy and straight mounting of adhesive metal strip z-tick to the banner. place z-tick strip on magnetic part, place the banner, push down - done.

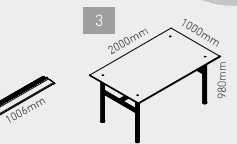
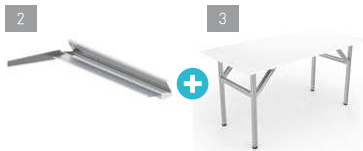

B MANUAL PRESS

2	MGSZTPRESS	z-tick press, 1pc
3	MGSZTPRTBL	table for z-tick press, 1pc

strips

METAL STRIPS

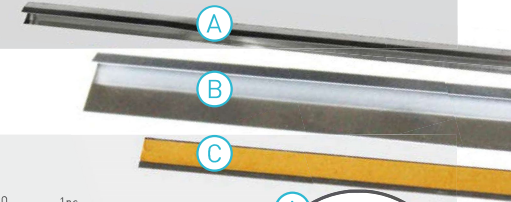

A V-METAL 1.0 CLIP-STRIP<sup>1)</sup>

		box 50	box 200	1pc
1	MGS1VL148			
2	MGS1VL297			
3	MGS1VL420			
4	MGS1VL500			
5	MGS1VL550			
6	MGS1VL594			
7	MGS1VL700			
8	MGS1VL750			
9	MGS1VL800			
10	MGS1VL841			
11	MGS1VL900			
12	MGS1VL950			
13	MGS1VL1000			
14	MGS1VL1150			
15	MGS1VL1190			

listello v-metal 1.0 da pressare al banner stampato. per l'uso con la pressa automatica 1.0

v-metal-leiste 1.0 zur bannerbeleistung mit automatischer presse 1.0

v-metal-strip 1.0 for banner finish with automatic press 1.0

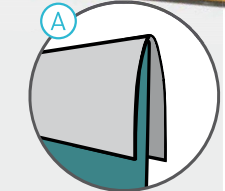

automatic press 1.0



A V-METAL 2.0 CLIP-STRIP<sup>1)</sup>

		box 50	box 200	1pc
16	MGS2VL148			
17	MGS2VL297			
18	MGS2VL420			
19	MGS2VL500			
20	MGS2VL550			
21	MGS2VL594			
22	MGS2VL700			
23	MGS2VL750			
24	MGS2VL800			
25	MGS2VL841			
26	MGS2VL900			
27	MGS2VL950			
28	MGS2VL1000			
29	MGS2VL1150			
30	MGS2VL1190			

listello v-metal 2.0 da pressare al banner stampato con la pressa 2.0

v-metal-leiste 2.0 zur bannerbeleistung mit manueller presse 2.0

v-metal-strip 2.0 for banner finish with manual press 2.0

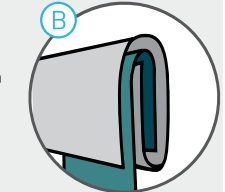

manual press 2.0

page 1.17



A Z-TICK<sup>1)</sup>

		box 50	box 200	1pc
31	MGSZT148			
32	MGSZT297			
33	MGSZT420			
34	MGSZT500			
35	MGSZT550			
36	MGSZT594			
37	MGSZT700			
38	MGSZT750			
39	MGSZT800			

listello metallico con biadesivo: fissaggio al banner semplice e veloce.

metalleiste mit doppelklebestreifen: bannerbeleistung schnell und einfach

metal-strip with double adhesive tape: quick and easy banner finish.

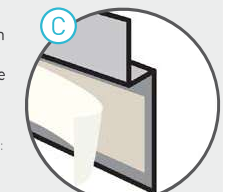

manual press

page 1.17



<sup>1)</sup>disponibile solamente in box da 50pz/200pz | nur in box50/box200 erhältlich | only available in box with 50pcs/200pcs





all systems in one look

## HANGING SYSTEMS



# overview banner systems suspended with profile

**IT** ti presentiamo i nostri sistemi a sospensione per esporre i tuoi banner. profili in alluminio, in materiale plastico o legno dotati di magneti o con sistema di fissaggio del banner a scorrimento. qui trovi la giusta soluzione per qualsiasi occasione!

**DE** hier präsentieren wir ihnen unsere systeme für die banner-abhängung: ob magnetisch, als klemmprofil oder mit einschubtechnik, ob aus kunststoff, holz oder alu: hier finden sie für jede anwendung genau die richtige lösung.

**EN** here we show you our new hanging systems. profiles with magnetic, clamping or insert technique, made from synthetics, wood or aluminium: here you'll find the perfect solution for your application.

### HANG UP ALU



page 1.2



### HANG UP SYNT



page 1.3



### HANG UP WOOD



page 1.4



### TOM 2.0



page 1.5



### EVO



page 1.6



### MINI EASYLOCK



page 1.7



square alu banner profile

## HANG UP ALU

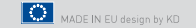

# magnetic suspension system square aluminium

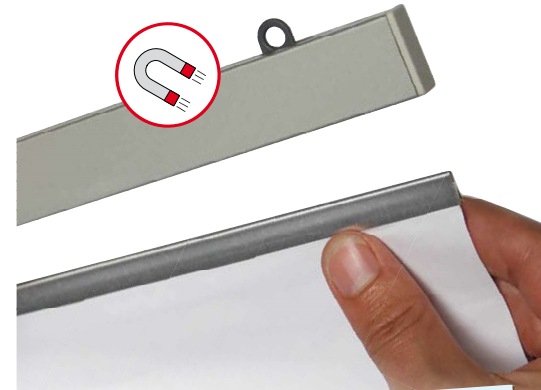

## your advantages

- ➔ profili in alluminio per un look elegante e prezioso
- ➔ elegantes aluminium profil für einen hochwertigen look
- ➔ elegant aluminium profile for a high-quality look

**IT** con un semplice click il banner è già fissato! myMAGO hang up alu è la variante a sospensione del sistema magnetico myMAGO. grazie al fissaggio magnetico è possibile cambiare alla velocità della luce il banner. il sistema permette di utilizzare banner in pvc, stoffa o carta con un listello metallico. ideale per vetrine di negozi o anche stand fieristici.

**DE** ein klick und schon ist ihr banner passgerecht aufgehängt. myMAGO hang up ist ein elegantes silbermatt eloxiertes aluminiumprofil mit hängeösen. beliebig oft verwendbar ist das profil der ideale aufhänger. so können sie ihren druck dank magnetischer befestigung blitzschnell wechseln. sie benötigen lediglich ein poster aus papier, stoffdruck, karton oder bannermaterial, das mit der metall-leiste versehen ist. myMAGO hang up alu ist ideal für den flexiblen bannerwechsel im schaufenster, foyer oder auch auf der messe.

**EN** one click and your banner is perfectly displayed. myMAGO hangup is an elegant silvermatt anodized aluminium profile with eyelets. you can use it again and again. your print is easily exchanged without any tools just with a magnetic click. all you need is a poster print on paper, fabric, cardboard or other material that is equipped with a metal strip. myMAGO hang up alu is the best choice for flexible banner exchange in the shop window, exhibition or supermarket.



banner not included

molla monuso per fissaggio a sospensione regolabile.  
höhenjustierbare einmal-abhängefeder  
single-use metal coils for ceiling suspension



A MYMAGO HANG UP ALU SET <sup>1)</sup>			
1	MMHUS302AL	mymago hang up alu 302mm, 1set	
2	MMHUS425AL	mymago hang up alu 425mm, 1set	
3	MMHUS505AL	mymago hang up alu 505mm, 1set	
4	MMHUS599AL	mymago hang up alu 599mm, 1set	
5	MMHUS705AL	mymago hang up alu 705mm, 1set	
6	MMHUS846AL	mymago hang up alu 846mm, 1set	
7	MMHUS1005AL	mymago hang up alu 1005mm, 1set	

<sup>1)</sup>ulteriori dimensioni e profili a metro disponibili su richiesta | weitere maße und meterware auf anfrage | more sizes and profiles to cut available on demand

METAL COIL <sup>2)</sup>		box 100	1pc
8	MGSMF120900	metal coil 120-900mm	
9	MGSMF2102000	metal coil 210-2000mm	

<sup>2)</sup>disponibile solamente in box da 100pz | nur in box zu 100st erhältlich | only available in box with 100pcs



2 hooks incl.

page 1.18





square synthetic profile **HANG UP SYNT**



MADE IN EU design by KD

# white synthetic square profile magnetic

**IT** profilo a sezione rettangolare in materiale sintetico disponibile in colore bianco, completo di ganci per il fissaggio e magneti con inserimento a incastro. grazie al sistema magnetico brevettato sarà sufficiente avvicinare semplicemente il banner ai magneti nella scanalatura del profilo per fissarlo.

**DE** hang up synt ist ein rechteckiges kunststoffprofil in modernem weiß mit ösen. dank der patentierten magnettechnik klicken sie den mit einer metall-leiste versehen banner einfach in die die magnetnut des profils ein.

**EN** hang up synt is a synthetic square profile in modern white with eyelets. thanks to the patented magnet technology you simply click the banner with its metal strip into the magnet notch of the profile.



## your advantages

- ➔ sistema espositivo a sospensione trendy e leggerissimo
- ➔ sehr trendiges hängesystem mit geringem gewicht
- ➔ very trendy hanging system with lean weight

**UNIQUE**  
double-side hanging system

per stampe mono o bifacciali  
für ein- und beidseitige drucke  
for single and double sided prints

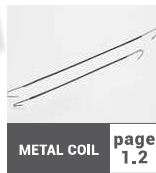

### A MYMAGO HANG UP SYNT SET <sup>1)</sup>

1	MMHYS302WH	mymago hang up synt (A4) 297mm, 1set	
2	MMHYS425WH	mymago hang up synt (A3) 420mm, 1set	
3	MMHYS505WH	mymago hang up synt 500mm, 1set	
4	MMHYS599WH	mymago hang up synt (A1)594mm, 1set	
5	MMHYS705WH	mymago hang up synt 700mm, 1set	
6	MMHYS846WH	mymago hang up synt (A2) 841mm, 1set	
7	MMHYS1005WH	mymago hang up synt 1000mm, 1set	



page 1.18

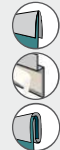

<sup>1)</sup> ulteriori dimensioni e profili a metro disponibili su richiesta | weitere maße und meterware auf anfrage | more sizes and profiles to cut available on demand

square wood profile **HANG UP WOOD**



MADE IN EU design by KD

# recyclable ecological solid non treated wood

**IT** display da terra in legno con sistema magnetico brevettato per un veloce e semplice cambio dell'informazione: sostenibile, ecologico e riciclabile.

**DE** stylisches hängeprofil aus massiver, unbehandelter buche mit integrierten magneten für die bannerbefestigung.

**EN** stylish suspension profile made of solid beech wood with integrated magnets for clicking in the banner.



## your advantages

- ➔ legno di faggio non trattato, nel rispetto dell'ambiente
- ➔ umweltfreundliches unbehandeltes buchenholz
- ➔ environmentally friendly non treated beech wood



l'alternativa ecologica  
die ökologische variante  
the ecological alternative

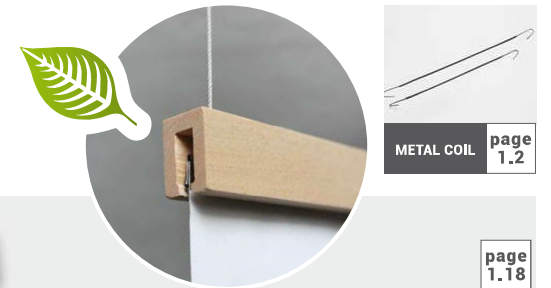

on request

### HANG UP WOOD

1	HUWD500	hang up wood, 500mm, 1pc	
2	HUWD700	hang up wood, 700mm, 1pc	
3	HUWD1000	hang up wood, 1000mm, 1pc	

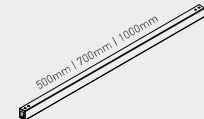

page 1.18







round hanging profile **TOM 2.0**



MADE IN EU quality control by KD

# magnetic aluminium round profile

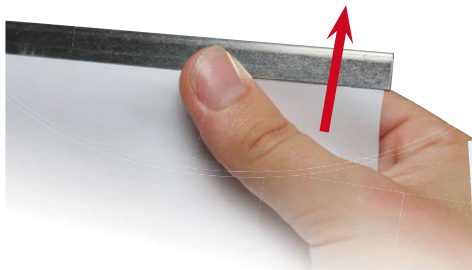

**IT** tom 2.0 è un profilo a sezione circolare in alluminio anodizzato color argento satinato, ideale per il fissaggio a sospensione o a parete del tuo banner. grazie ai magneti inseriti nel profilo, sarà semplicissimo fissare il banner tramite i listelli metallici. tom 2.0 è composto da un profilo superiore con integrati due occhielli per la sospensione e un profilo inferiore.

**DE** tom 2.0 ist ein rundes silbermatt eloxiertes aluminiumprofil für die deckenabhängung oder wandmontage ihrer beleiteten banner. dank der im profil eingelassenen magneten klicken sie den banner mit den metall-leisten einfach in die nut ein. tom 2.0 kommt mit zwei integrierten ösen und je einem profil für oben und unten.

**EN** tom 2.0 is a round silver matt anodized aluminium profile for ceiling suspension or wall mount of your banner with metal strips. thanks to the clever magnet technology you simply insert the banner with the metal strips into the profile. tom 2.0 comes with two integrated eyelets and one profile for top and bottom.

semplicemente magnetico  
einfach magnetisch  
simply magnetic

## your advantages

- ➔ presentazione bifacciale
- ➔ doppelseitige präsentation
- ➔ double-sided presentation

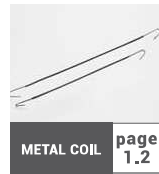

page 1.18

A	TOM 2.0		
1	MGS2TS425*	tom 2.0 425mm, 1set	
2	MGS2TS505*	tom 2.0 505mm, 1set	
3	MGS2TS599*	tom 2.0 599mm, 1set	
4	MGS2TS705*	tom 2.0 705mm, 1set	
5	MGS2TS1005*	tom 2.0 1005mm, 1set	



\* fino ad esaurimento scorte | solange vorrart reicht | while stock last



rail hanging system **EVO**



MADE IN EU quality control by KD

# insert suspension system aluminium



## your advantages

- ➔ sistema semplicissimo senza magneti
- ➔ einfaches system ohne magnet
- ➔ simple system without magnet

**IT** evo è un profilo a sezione circolare in alluminio anodizzato color argento satinato, ideale per il fissaggio a sospensione o a parete del tuo banner. inserisci il listello metallico del banner lateralmente nella scanalatura del profilo e fissalo chiudendo il tappo laterale.

**DE** evo ist ein rundes silbermatt eloxiertes aluminiumprofil zur befestigung ihres beleiteten banners an der decke oder wand. die metall-leiste des banners wird einfach seitlich in die profilnut eingeschoben und mit der kappe gesichert.

**EN** evo is a round silver matt anodized aluminium profile to mount your banner at the ceiling or to the wall. to display your banner simply slide in the metal strip laterally and close with the side cap.



inserire il listello dal lato del profilo  
leiste wird seitlich eingeschoben  
slide in the strip laterally

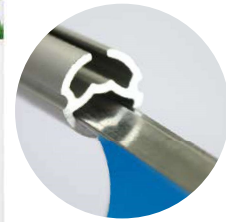

page 1.18

A	EVO <sup>1)</sup>		
1	MGS1ES425	evo profil alu 1,0 425mm, 1set	
2	MGS1ES505	evo profil alu 1,0 505mm, 1set	
3	MGS1ES599	evo profil alu 1,0 599mm, 1set	
4	MGS1ES705	evo profil alu 1,0 705mm, 1set	
5	MGS1ES1005	evo profil alu 1,0 1005mm, 1set	



<sup>1)</sup> ulteriori dimensioni e profili a metro disponibili su richiesta | weitere maße und meterware auf anfrage | more sizes and profiles to cut available on demand

banner clamp profile

**MINI EASYLOCK**



MADE IN EU quality control by KD

# clamping suspension system square profile

**IT** il profilo a scatto in alluminio anodizzato color argento satinato per il fissaggio del banner funziona senza magneti né listelli a pressione. basterà aprire il profilo, inserire il banner e richiuderlo con un semplice clic.

**DE** das silbermatt eloxierte klemmprofil für die bannerbefestigung funktioniert ganz ohne magnettechnik oder verpresste leisten. einfach klemmprofil öffnen, banner einschieben und mit einem klick wieder verschließen.

**EN** the silvermatt anodized clamping profile for banner mounting works without magnet technique or pressed strips. just open the clamp profile, place the banner and fix it with one click.

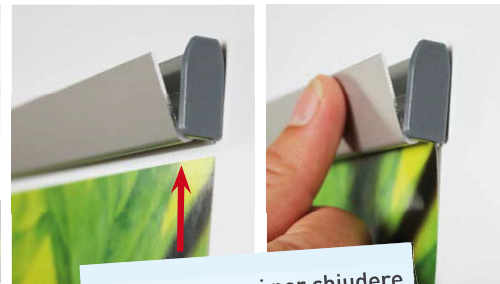

## your advantages

➔ pratico profilo a scatto

➔ praktisches klemmprofil

➔ convenient clamping profile

inserisci e premi per chiudere  
einschieben und zudrücken  
insert and push to close



METAL COIL page 1.2

**A** MINI EASYLOCK <sup>1)</sup>

1	MGSELS505	mini easylock for 500, 1set
2	MGSELS705	mini easylock for 700, 1set
3	MGSELS1005	mini easylock for 1000, 1set
4	MGSELS1205	mini easylock for 1200, 1set
5	MGSELS1505	mini easylock for 1500, 1set
6	MGSELS2005	mini easylock for 2000, 1set



<sup>1)</sup>ulteriori dimensioni e profili a metro disponibili su richiesta | weitere maße und meterware auf anfrage | more sizes and profiles to cut available on demand

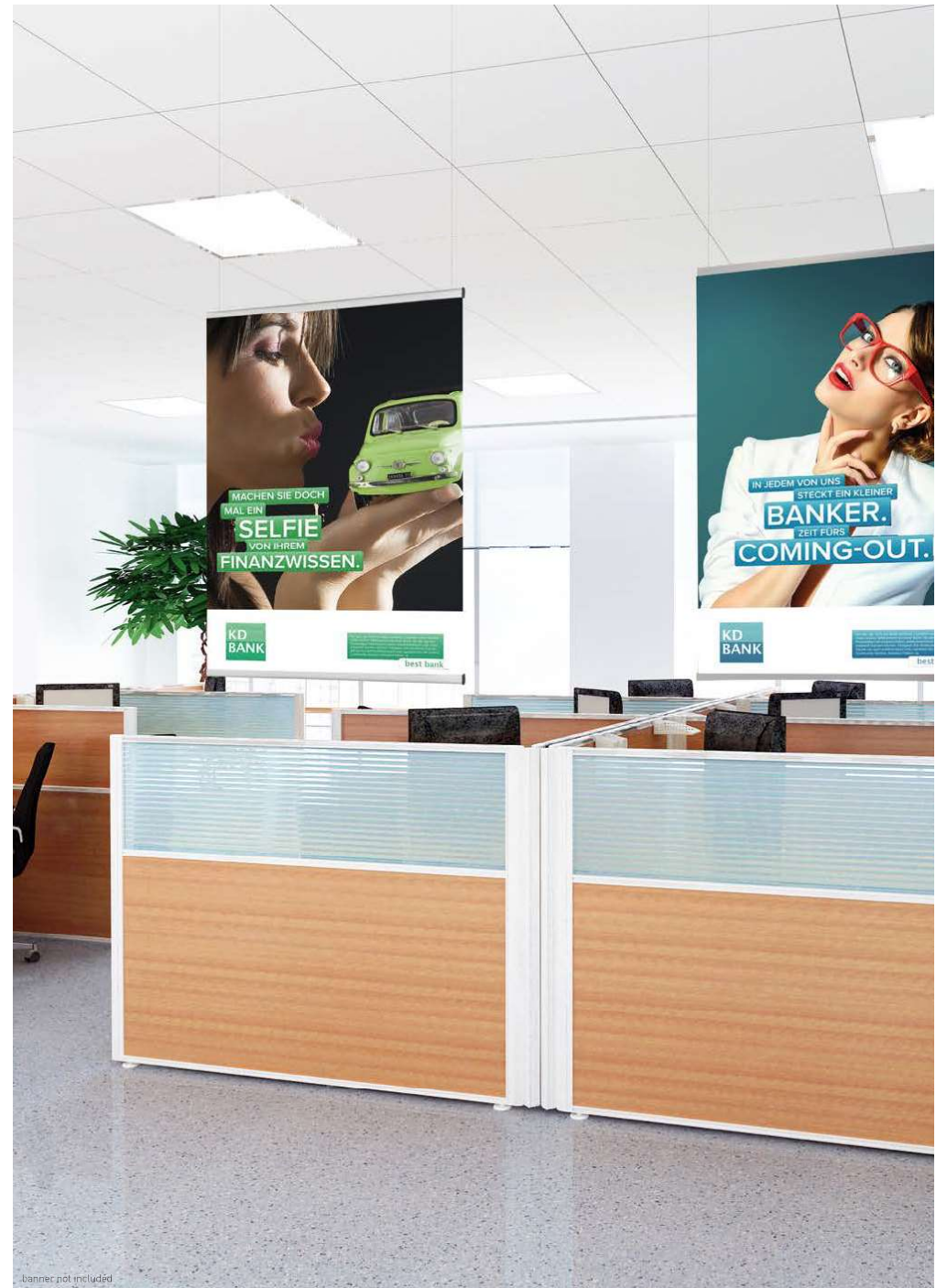

banner not included



suspension system

**TRANSPARENT SUSPENSION**

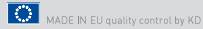

transparent  
suspension system  
for steel cable  
or synthetic cable

**IT** cavo di nylon trasparente con pratiche clip in alluminio. lunghezza regolabile secondo necessità. pinza da ordinare separatamente.

**DE** transparentes nylonseil zum selbst ablängen mit praktischen aluminium-clips, die zange bestellen sie nach bedarf extra.

**EN** convenient transparent cord can be cut to needed length with handy aluminium clips. the fixing tool order extra



**9kg** carico massimo 9kg  
bis zu 9kg traglast  
maximum load 9 kg



A TRANSPARENT SUSPENSION	
1	MMFCV10 aluminium clips 1mm, set 50pcs
2	MMFCV15 aluminium clips 1,5mm, set 50pcs
3	MMFCV20 aluminium clips 2mm, set 50pcs
4	MMFI25 synthetic cable, roll 25m
5	AFILIX25 steel cable Ø1,2mm, 25m
6	MMPNZ* pliers, 1pc

\*ordinare a parte | extra bestellen | order extra

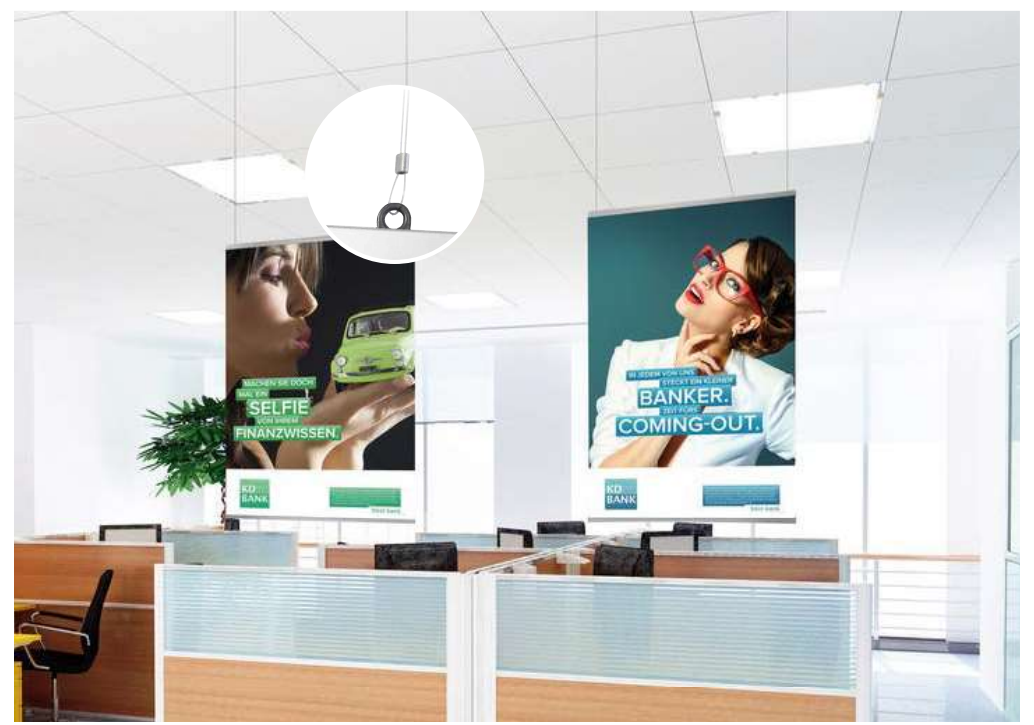



fixing system

**PANEL PINCH**



# no holes suspension support movable walls

**IT** soluzione universale di fissaggio per poster. zero fori sul muro: il sistema a vite consente di installare panel pinch su strutture senza rovinare la parete. alluminio anodizzato color argento satinato.

**DE** universelle Befestigung für poster ohne Lochbohrung der wand. speziell empfohlen für stellwände diverser stärken, einfaches schraub-klemmsystem aus silbermatt eloxiertem aluminium.

**EN** multi-purpose support for poster suspension without holes in the wall. especially recommended for movable walls as the screw clamp design allows the installation on structures without holes. made from silver matt anodized aluminium.

## your advantages

- ➔ zero fori sul muro, applicabile a pareti di diverso spessore
- ➔ keine lochbohrung, für stellwände diverser stärken
- ➔ no holes needed, for movable walls with different thicknesses

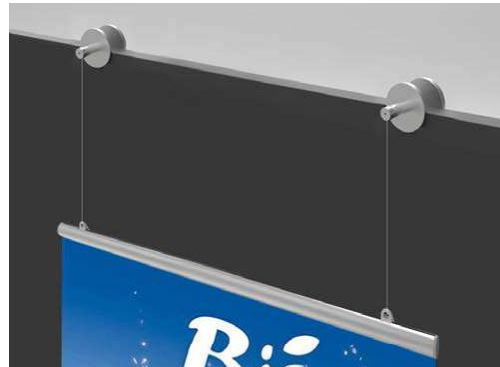
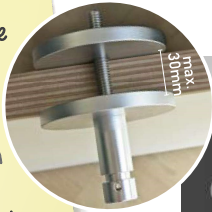

**A** PANEL PINCH

1	FPP50AL*	panel pinch, 1pc	
---	----------	------------------	--

\* disponibile da agosto | ab august verfügbar | available in august

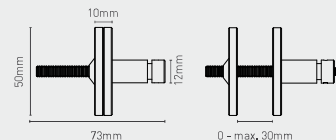

per pannelli fino a 30mm spessore  
für panele bis max. 30mm stärke  
for panels up to 30mm thickness

bulk pack

**FISSO KIT 40**



## your advantages

- ➔ vassoio antigraffio praticità assoluta
- ➔ sicher verpackt praktische entnahme
- ➔ safe packing handy take out

**IT** kit di montaggio per specialisti, perfetto per tenere in ordine e avere accesso veloce a tutti i prodotti necessari all'installazione. cacciavite incluso. confezione a vassoio con protezione antigraffio per i distanziali. soluzione sostenibile.

**DE** praktische grosspackung für schnelle montage. wand-schrauben, -dübel und schraubendreher inklusive. die praktische verpackung schützt jeden abstandhalter perfekt bei transport und lagerung.

**EN** handy bulk pack for the quick take out during mounting. wall screws, dowels and screwdriver included. the convenient container protects every single spacer perfectly during storage and transport.



**A** FISSO STEEL KIT 40

	1pc	box 40
1 FS1315KIT	fisso steel 1315	
2 FS1320KIT	fisso steel 1320	
3 FS1515KIT	fisso steel 1515	

**A** MIX ALU KIT 40

	1pc	box 40
7 FMX1313ALKIT	mix alu 1313	
8 FMX1320ALKIT	mix alu 1320	

**A** MIDI KIT 40

	1pc	box 40
4 F1521CMKIT	midi chrome	
5 F1521ARKIT	midi silver	
6 F1521GDKIT	midi gold	

**A** RAPID KIT 40

	1pc	box 40
9 FRA1520CMKIT	rapid chrome	
10 FRA1520ARKIT	rapid silver	
11 FRA1520GDKIT	rapid gold	



fixing system

FISSART 45°



# invisible & clever mounting system always straight position

**IT** fissart 45° è il sistema di fissaggio invisibile perfetto per targhe di segnaletica, pannelli pubblicitari e decorativi. vantaggio assoluto è che l'informazione risulta ben dritta anche nel caso in cui i fori a muro siano stati effettuati con un dislivello fino a 5cm. per il montaggio posizionare fissart 45° sul retro del pannello e incollarlo con il nastro biadesivo. applicare poi le viti a muro, appendere e aggiustare l'inclinazione dell'immagine. sistema semplice. le 2 viti a muro con tasselli sono incluse nella confezione.

**DE** fissart 45° ist das perfekte, unsichtbare Befestigungssystem für bilder, schilder, paneele oder werbetafeln. der clou ist, dass das bild gerade hängt, auch wenn die wandschrauben bis zu 5cm höhen-versetzt montiert wurden. einfach die fissart 45° dank randabstandsbügel auf der rückseite des paneels positionieren und festkleben. danach auf 2 wandschrauben aufsetzen und gerade ausrichten – ganz einfach. mit dabei sind je zwei wandschrauben mit dübel.

**EN** fissart 45° is the perfect invisible mounting system for pictures, signs, panels or promotion boards. the clever system allows to position a panel straight even with a difference height up to 5cm of the wall screws. simply place the fissart 45° on the rear side in position and fix with double adhesive tape. then hang on the wall screws and straighten the panel - very simple and manageable. included are two wall screws with dowels.

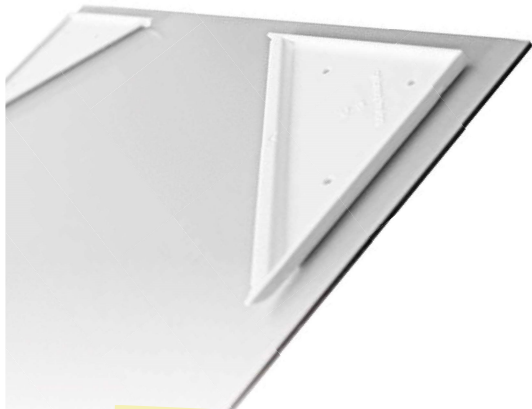

## your advantages

- ➔ invisibile regolabile manualmente
- ➔ unsichtbar nur von hand gerade ausrichten
- ➔ invisible put it straight just by hand

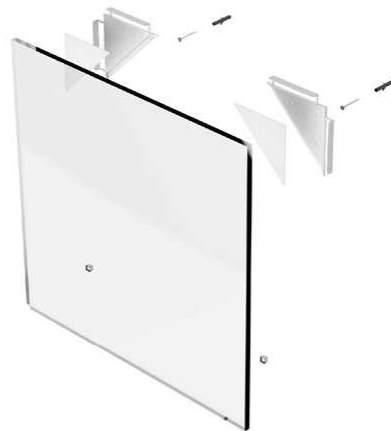

4kg

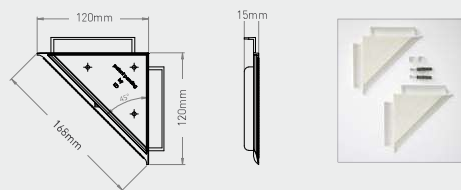

<b>A</b>	FISSART 45°	
<b>1</b>	FIA45	fissart 45°, set 2pcs



per pannelli sempre dritti!  
nie mehr schiefe bilder!  
guaranteed straight images!

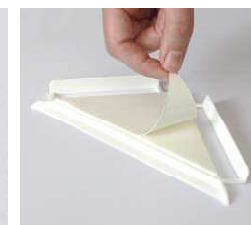
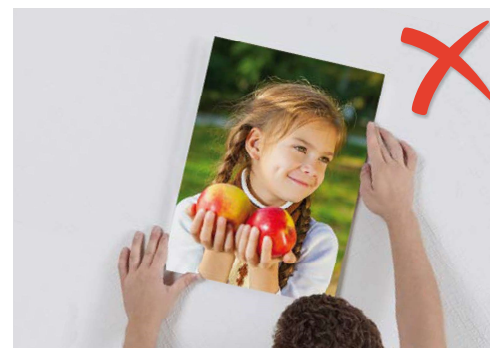

posizionare fissart 45° sul retro del pannello e incollarlo con il nastro biadesivo  
fissart 45° dank randabstandsbügel auf der rückseite des paneels positionieren und festkleben  
place the fissart 45° on the rear side in position and fix with double adhesive tape



applicare le viti a muro, appendere e aggiustare l'inclinazione dell'immagine  
auf 2 wandschrauben aufsetzen und gerade ausrichten  
hang on the wall screws and straighten the panel



flagpole without hoisting **TURNIER**

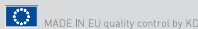

# standard flagpole without hoisting device

**IT** la versione base delle nostre bandiere: pennone in prezioso alluminio anodizzato color argento con supporto per la base da interrare, sistema verticale per issare la bandiera grazie ai tiranti, peso anti-sollevamento e per una rimozione facile della bandiera stessa. il pennone viene consegnato in 3 parti, per un trasporto ottimale. consigliamo l'utilizzo di un dispositivo di ribaltamento per lo scambio più semplice della bandiera.

**DE** die basis version unserer fahnensysteme: fahnenmast aus hochwertigem silber eloxiertem aluminium mit bodenhülse zum einbetonieren, vertikaler fahnentuchführung durch gurtschlaufen am mast, gewicht gegen hochwehen und für ein leichtes einholen der fahne. geliefert wird der mast transportoptimiert in drei teilen. wir empfehlen die kippvorrichtung für den einfachen fahnentausch.

**EN** the basic version of our flagpole systems: flagpole made of high-grade silver anodized aluminium with a ground sleeve to set in concrete, vertical guidance of the flag on the pole, weight to protect the flag from flying up and to take it easily down. the flagpole is delivered in three pieces for better transport. we suggest the tilting device for a simplified flag exchange.



dispositivo per issare la bandiera escluso, ordina extra la cerniera per il ribaltamento del pennone  
ohne hissvorrichtung, kippcharnier extra bestellen  
without flag hoisting, order extra tipping hinge



puntale con braccio telescopico  
mastkopf mit ausleger  
mast cap with extension arm

fissaggio della bandiera  
fahnentuchbefestigung  
bunting fixing

pennone smontabile in 3 parti  
grazie al sistema ETM  
ETM system teilt den mast in 3 teile  
sistema ETM divides the pole in 3 parts



**MORE SUPPORTS** page 1.29



supporto della base da integrare incluso  
bodenhülse zum einbetonieren inklusive  
ground sleeve to set in concrete incl

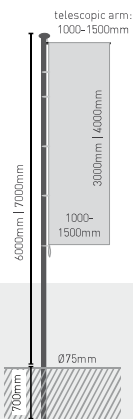
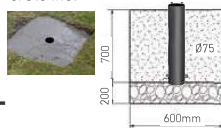

- larghezza dell'orlo 80 mm per il tubo di Ø40mm  
- saumbreite 80mm für rohr Ø40mm  
- flag border 80mm for tube Ø40mm

B	TURNIER <sup>1)</sup>		
1	DFT6000ETM	turnier 6700mm, 1pc	
2	DFT7000ETM	turnier 7700mm, 1pc	

<sup>1)</sup> merce voluminosa: ritiro con vs corriere e/o spedizione assieme ad altra merce non possibile.  
<sup>2)</sup> sperrgut: keine selbstabholung, kein versand mit anderen waren.  
<sup>3)</sup> bulk goods: no ex works collections possible, no shipping along with other goods



flagpole with hoisting **PIRATA**



# classic flagpole hoisting device telescopic lockable

**IT** il classico: una bandiera di qualità, in alluminio anodizzato color argento con pratico dispositivo per issare e abbassare la bandiera stessa con grande facilità. la bandiera pirata, in aggiunta alle caratteristiche del sistema turnier, comprende anche un dispositivo a serratura interno e un braccio telescopico mobile.

**DE** der klassiker: ein qualitativ hochwertiges fahnensystem aus silber eloxiertem aluminium mit praktischer hissvorrichtung zum schnellen einholen und hissen der fahne. pirata bietet zusätzlich zu den merkmale des fahnensystems turnier eine innenliegende, abschließbare, händische hissvorrichtung und einen hissbaren, teleskopischen drehausleger.

**EN** the classic choice: a high-quality flagpole made of silver anodized aluminium with handy hoisting device which makes it very easy to take up and down the flag. pirata offers in addition to the features of the flagpole system turnier an internal, lockable winch and telescopic, turnable flag arm.



dispositivo per issare la bandiera con serratura  
abschließbare hissvorrichtung  
lockable winch

puntale con braccio telescopico  
mastkopf mit ausleger  
mast cap with extension arm



fissaggio della bandiera  
fahnentuchbefestigung  
bunting fixing



pennone smontabile in 3 parti  
grazie al sistema ETM  
ETM system teilt den mast in 3 teile  
sistema ETM divides the pole in 3 parts

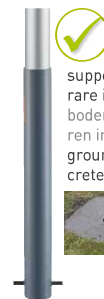
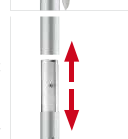

supporto della base da integrare incluso  
bodenhülse zum einbetonieren inklusive  
ground sleeve to set in concrete incl

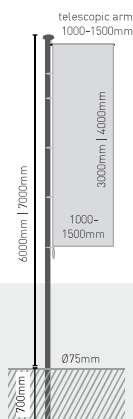
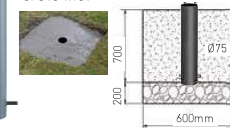

- larghezza dell'orlo 80 mm per il tubo di Ø40mm  
- saumbreite 80mm für rohr Ø40mm  
- flag border 80mm for tube Ø40mm

B	PIRATA <sup>1)</sup>		
1	DFP6000ETM	pirata 6700mm, 1pc	
2	DFP7000ETM	pirata 7700mm, 1pc	

<sup>1)</sup> merce voluminosa: ritiro con vs corriere e/o spedizione assieme ad altra merce non possibile.  
<sup>2)</sup> sperrgut: keine selbstabholung, kein versand mit anderen waren.  
<sup>3)</sup> bulk goods: no ex works collections possible, no shipping along with other goods





flagpole with hoisting **BURAN**

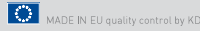

# premium flagpole hoisting device with cranc

**IT** la bandiera per le richieste più esigenti: buran è composta da un pennone a sezione cilindrica in alluminio anodizzato color argento e garantisce un cambio della bandiera particolarmente rapido e pratico. il pennone può essere alzato o abbassato grazie al funzionale sistema a manovella.

**DE** die fahne für die höchsten ansprüche: buran besteht aus einem zylindrischen fahnenmast aus silber eloxiertem aluminium und überzeugt durch einen besonders schnellen und bequemen fahnenwechsel. dank der integrierten kurbel wird der fahnenausleger ganz einfach nach oben und unten bewegt.

**EN** this flag satisfies even the highest standards: buran is a cylindric flagpole made of high-grade silver anodized aluminium which offers a particulory quick and simple flag exchange. thanks to the cranc the flag arm can be easily taken up and down.



sistema a manovella per issare la bandiera  
hissvorrichtung mit kurbel  
hoisting device with cranc

puntale con braccio telescopico  
mastkopf mit ausleger  
mast cap with extension arm

fissaggio della bandiera  
fahnentuchbefestigung  
bunting fixing

pennone smontabile in 3 parti  
grazie al sistema ETM  
ETM system teilt den mast  
in 3 teile  
sistema ETM divides the pole  
in 3 parts



supporto della base da integrare incluso  
bodenhülse zum einbetonieren inklusive  
ground sleeve to set in concrete incl

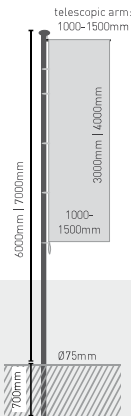

- larghezza dell'orlo 80 mm per il tubo di Ø40mm  
- saumbreite 80mm für rohr Ø40mm  
- flag border 80mm for tube Ø40mm

B	BURAN <sup>1)</sup>	
1	DFB6000ETM	buran 6700mm 1pc
2	DFB7000ETM	buran 7700mm, 1pc

<sup>1)</sup> merce voluminosa: ritiro con vs. corriere e/o spedizione assieme ad altra merce non possibile.  
<sup>\*)</sup> sperrgut: keine selbstabholung, kein versand mit anderen waren.  
<sup>†)</sup> bulk goods: no ex works collections possible, no shipping along with other goods



flagpole **MOBILIS**

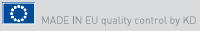

# flagpole mobile stable

**IT** pennone in alluminio anodizzato color argento con pratica base a U in acciaio. il pennone può essere facilmente inserito nella base, la quale può essere bloccata, ad esempio, dalle ruote di un'auto. la bandiera rimane stabile e sicura e il messaggio pubblicitario potrà essere presentato in qualsiasi posto.

**DE** mobiler fahnenmast aus silber eloxiertem aluminium mit praktischem u-förmigen standfuß aus stabilem stahl. der fahnenmast wird einfach in den fuß eingesteckt. der standfuß wird z.b. durch ein automobil beschwert. so steht ihre fahne sicher und stabil und präsentiert ihre werbebotschaft flexibel an jedem gewünschten platz.

**EN** flagpole made of high-grade silver anodized aluminium with u-shaped flagpole foot made of stable steel. the flagpole can be easily put into the foot. the foot must be fixed with weight e.g. by a car. your flag will remain stable and secure and your advertising message can be presented everywhere you want.



base stabile in acciaio  
sicherer standfuß aus stahl  
secure steel foot

puntale con braccio telescopico  
mastkopf mit ausleger  
mast cap with extension arm

fissaggio della bandiera  
fahnentuchbefestigung  
bunting fixing

puntale smontabile in 2 parti grazie al sistema ETM  
ETM system teilt den mast in 2 teile  
sistema ETM divides the pole in two parts



- larghezza dell'orlo 80 mm per il tubo di Ø40mm  
- saumbreite 80mm für rohr Ø40mm  
- flag border 80mm for tube Ø40mm

B	MOBILIS <sup>1)</sup>	
1	DFM5000ETM	mobilis 5000mm, 1pc

<sup>1)</sup> merce voluminosa: ritiro con vs. corriere e/o spedizione assieme ad altra merce non possibile.  
<sup>\*)</sup> sperrgut: keine selbstabholung, kein versand mit anderen waren.  
<sup>†)</sup> bulk goods: no ex works collections possible, no shipping along with other goods

flagpole

WALL SUPPORT

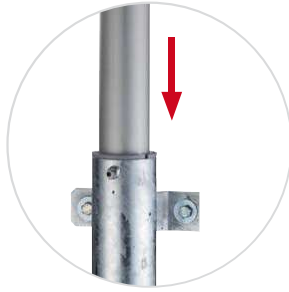
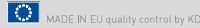

per pennoni con diametro 75mm, 90mm o 100mm  
für fahnenmastdurchmesser: Ø75mm, 90mm, 100mm  
for flagpole diameter Ø75mm, 90mm, 100mm

**IT** il sistema di fissaggio wall support permette un semplice fissaggio del pennone della bandiera alla parete. sarà sufficiente inserire il pennone nel supporto a parete aiutandosi col tassello di centraggio. la bandiera si fissa così in modo stabile.

**DE** die wandhalterung ermöglicht eine einfache montage des fahnenmastens an die wand. die fahnenmasten werden mit übergeschobenen zentrierkeil in die wandhalterung eingesetzt. ihre fahne wird stabil fixiert.

**EN** the wall fixing system enables an easy mounting of the flagpole to the wall. just insert the flagpole into the wall support by a centering wedge. your flag will be held steady.

B FOR WALL MOUNTING<sup>1)</sup>

1	DFWLS	wall support, 1 pc
---	-------	--------------------

<sup>1)</sup> merce voluminosa: ritiro con vs corriere e/o spedizione assieme ad altra merce non possibile.  
<sup>2)</sup> sperrgut: keine selbstabholung, kein versand mit anderen waren  
<sup>3)</sup> bulk goods: no ex works collections possible, no shipping along with other goods

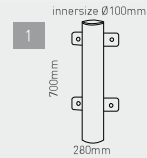

flagpole

SUPPORT

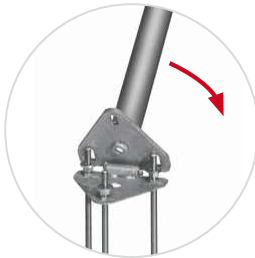
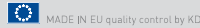

per pennoni con diametro 75mm  
für fahnenmastdurchmesser: Ø75mm  
for flagpole diameter Ø75mm

**IT** pratico dispositivo di ribaltamento per issare la bandiera con semplicità grazie alla possibilità di inclinare il pennone. flagpole non dev'essere rimosso dal supporto a terra. Il pennone si posiziona e fissa tramite tre viti. la guida interna per l'inserimento del pennone garantisce grande visibilità e stabilità.

**DE** praktische kipphalterung für geführtes aufstellen des fahnenmastes durch kippfunktion. mast muss nicht aus der bodenhülse gehoben werden. präzise mastjustierung durch drei schraubverbindungen. innenliegende mastführung bietet optischen und statischen vorteil.

**EN** clever tilting device for a guided flagpole hoisting thanks to the possibility to tilt the pole. flagpole doesn't has to be taken of the ground sleeve. exact setting of the flagpole thanks to three screw fittings. internal pole guidance offers visual and static advantages.

B SUPPORT<sup>1)</sup>

2	DFFLS	support, 1 pc
---	-------	---------------

<sup>1)</sup> merce voluminosa: ritiro con vs corriere e/o spedizione assieme ad altra merce non possibile.  
<sup>2)</sup> sperrgut: keine selbstabholung, kein versand mit anderen waren  
<sup>3)</sup> bulk goods: no ex works collections possible, no shipping along with other goods

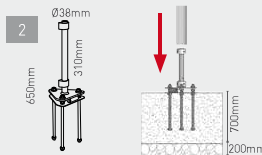

your advantages

⇒ pennone smontabile per maggiore semplicità di trasporto e logistica

⇒ mast zerlegbar für optimale frachtkosten und logistik

⇒ flagpole can be divided for lower transportation costs and easier logistics



speciale: pennone luminoso su richiesta  
special: beleuchteter fahnenmast auf anfrage  
special! illuminated flagpole on request!

